

Duct Foils and CPC Consumables • Ink Duct End Blocks • Hickey Removers • Sheet Separators • Tower Coater Blades • Miscellaneous Products • Delivery Blowdown Fans • Pneumatic Springs • Feeder Brush Wheels • Grease Gun • Rubber Feed Board Wheels • Gripper Pad Gauge • CPC Push Buttons • O-rings (Sheet Slowdown) • Sheet hold downs • Ink Knives and Paper Wedges • Feeder Belts • Magnifying Glasses • Rubber Suckers • Wash-Up Blades • Cylinder Jackets • Recirculation Filters • Plate Correction Pens • Plate Correction Gels • Wash-Up Bottle • LubeClean • SuperClean • Ink Duct Foils and CPC Consumables • Ink Duct End Blocks • Hickey Removers • Sheet Separators • Tower Coater Blades • Miscellaneous Products • Delivery Blowdown Fans • Pneumatic Springs • Feeder Brush Wheels • Grease Gun • Rubber Feed Board Wheels • Gripper Pad Gauge • CPC Push Buttons • O-rings (Sheet Slowdown) • Sheet hold downs • Ink Knives and Paper Wedges • Feeder Belts • Magnifying Glasses • Rubber Suckers • Wash-Up Blades • Cylinder Jackets • Recirculation Filters • Plate Correction Pens • Plate Correction Gels • Wash-Up Bottle • LubeClean • SuperClean • Ink Duct Foils and CPC Consumables • Ink Duct End Blocks • Hickey Removers • Sheet Separators • Tower Coater Blades • Miscellaneous Products • Delivery Blowdown Fans • Pneumatic Springs • Feeder Brush Wheels • Grease Gun • Rubber Feed Board Wheels • Gripper Pad Gauge • CPC Push Buttons • O-rings (Sheet Slowdown) • Sheet hold downs • Ink Knives and Paper Wedges • Feeder Belts • Magnifying Glasses • Rubber Suckers • Wash-Up Blades • Cylinder Jackets • Recirculation Filters • Plate Correction Pens • Plate Correction Gels • Wash-Up Bottle • LubeClean • SuperClean

KOMOS  
N ■ MIEHLE ■ MULTILITH  
R ■ MARTINI ■ MULTILITH  
O ■ PHILLIPSBURG ■ RICE ■ SHEET  
■ SAKURAY ■ SANDMAR ■ THOMPSON  
■ THISEN & BONITZ ■ AB-DICKSON  
■ WOHLEMBERG ■ C&P ■ D  
■ AURELIA-OMSCA-REDAELLI ■ C  
■ MODULEN ■ BREMER ■ DIDDIE GL  
■ ABTREE ■ GESTETNER ■ GIANT  
■ OHARA ■ HEIDELBERG ■ STITCHM  
■ DELBERG ■ KLUGE ■ KOLBUS ■ M  
■ KLOCKNER ■ M.A.N. ■ MC CAIN ■ M  
■ MAJOR ■ MULLER MARTINI  
■ PHILIP  
■ SAKURAY

*keep it  
running...*

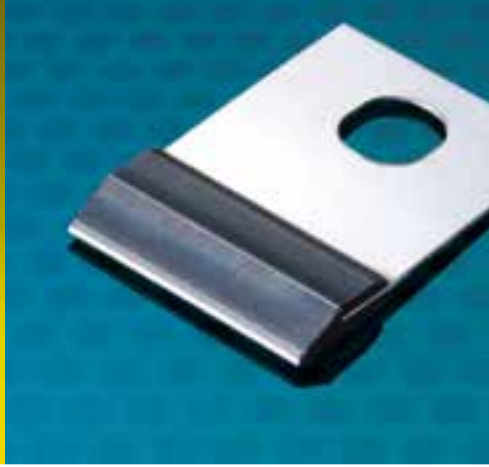



## 2 Ink Duct Foil and CPC Consumables

## 6 Ink Duct End Blocks

- Duct insulating strips
- Scraper cleaners
- Heidelberg PM/QM dampening seals
- Kompac dampening seals
- Cleaning felts (bearer wipes)

## 13 Performance Non-Woven Wash Cloth

## 14 Recirculation Filters

- Filter bags
- Eliminator ink absorbent mesh bags
- Filter mats
- Misting filters

## 21 Anti-Marking Paper and Film

## 22 Cabinet Air Filters

## 24 Feeder Belts and Slow Down Belts

- Belt gluing unit and belt glue

## 36 Sheet Separators and Feeder Brushes

## 46 Brush Wheels and Rubber Wheels

## 56 Hickey Removers

## 60 Master Pack Underlay Packing Paper

## 61 Doctor Blades and Tresu D2 Seals

- Steel and brass brushes for anilox rollers

## 62 Miscellaneous

- KBA – various parts
- Mitsubishi - various parts
- Komori – various parts
- Goss sheet guides

- Lifting sucker nozzles
- Blanket wash profile rubber
- Tower coater blades
- CPC buttons
- CPC Servo motors
- Festo valves and servo drives
- Plate springs
- Gauged steel (ink roller adjustment)
- Pneumatic springs
- Oil, air and fount filters
- Sheet smoothers (hold downs)
- Sheet stops (guide straps)
- O-rings
- Parts for Platen T and GT
- Tools
- Wash-up bottles, sponges, scrubbers, wiper pads, brass and steel brushes

## 78 Grippers and Gripper Pads

## 82 Ink Knives and Ink Can Openers

## 84 Paper Wedges, Paper Pile Corners and Reel Cutters

## 86 Magnifying Glasses

## 88 Cutting Sticks, Magnetic Pads, Knife Guards and Jogger Blocks

## 92 Cylinder Jackets

## 96 Wash-up Blades

## 107 Suckers

## 129 LubeClean – Roller Lubricating Paste Roller Master – Roller Cleaning Paste Plate Correction Pens Positive Deletion Gel Revive Blanket Repair

**DISCLAIMER:** Master Products featured in this publication are produced by an independent manufacturer and supplier of high quality replacement parts. The manufacturer of Master Products is not a licensee to any original equipment manufacturer ("OEM"), and disclaims any affiliation with any OEM concerning the Master Products parts. The use of an OEM name or trademark is for identification purposes only and is not intended to cause or create confusion regarding the quality, source, or sponsorship of the Master Products. Any OEM referenced in this publication is not intended to be and is not to be construed as an approval, endorsement, guarantee, promotion, recommendation, sponsorship, or warranty of the Master Products. Heidelberg, KBA, Komori, manroland, Mitsubishi and other mentioned brands are registered trademarks of their individual parent companies.



# Ink Duct Foil and CPC Consumables

The Elite Foil range is manufactured to high tolerances from top-grade PET material ensuring:

- Maximum chemical, thermal and mechanical strength for long life without ink duct contamination.
- Only virgin resin suppliers are used - no recycled polyester.
- Tested using both conventional and UV inks.
- Permanently formed for a secure and accurate fit.
- Compact, low volume packaging for safe, easy and cost effective transportation and storage.

## ELITE FOIL SPECIFICATIONS

CODE	DESCRIPTION	SIZE	PACKAGING
0.19mm/0.0075"			
EFOILQM	Ink Duct Foil for Heidelberg QM 46	358 x 200 mm	100 foil/box
EFOILGT052	Ink Duct Foil for Heidelberg GT052	547 x 200 mm	100 foil/box
EFOILSM52	Ink Duct Foil for Heidelberg SM52	547 x 197 mm	100 foil/box
EFOILM0	Ink Duct Foil for Heidelberg M0	676 x 200 mm	100 foil/box
EFOIL72	Ink Duct Foil for Heidelberg SM72	775 x 232 mm	100 foil/box
EFOILSX74	Ink Duct Foil for Heidelberg SX74	775 x 197 mm	100 foil/box
EFOIL7475	Ink Duct Foil For Heidelberg SM74-CD74-XL75	775 x 229 mm	100 foil/box
EFOIL102	Ink Duct Foil for Heidelberg SM102	1068 x 232 mm	100 foil/box
EFOILCD105	Ink Duct Foil for Heidelberg CX/CD102/XL105	1068 x 229 mm	100 foil/box
EFOIL145	Ink Duct Foil for Heidelberg XL145	1478 x 265 mm	100 foil/box
EFOIL162	Ink Duct Foil for Heidelberg XL162	1672 x 265 mm	100 foil/box
EFOILW8	Ink Duct Foil for WEB 8	548 x 260 mm	50 foil/box
EFOILW110	Ink Duct Foil for MC-110	740 x 260 mm	50 foil/box
EFOILW130	Ink Duct Foil for WEB 130	994 x 260 mm	50 foil/box
EFOILW16	Ink Duct Foil for WEB 16 / M600 w/foam	1002 x 260 mm	50 foil/box
EFOILW16S	Ink Duct Foil for Goss M600 w/2 notches w/foam	1002 x 260 mm	50 foil/box
0.25mm/0.01"			
EFOIL25QM	Ink Duct Foil for Heidelberg QM 46	358 x 200 mm	100 foil/box
EFOIL25GT052	Ink Duct Foil for Heidelberg GT052	547 x 200 mm	100 foil/box
EFOIL25SM52	Ink Duct Foil for Heidelberg SM52	547 x 197 mm	100 foil/box

## ELITE FOIL SPECIFICATIONS

CODE	DESCRIPTION	SIZE	PACKAGING
EFOIL25M0	Ink Duct Foil for Heidelberg MO	676 x 200 mm	100 foil/box
EFOIL2572	Ink Duct Foil for Heidelberg SM72	775 x 232 mm	100 foil/box
EFOIL25SX74	Ink Duct Foil for Heidelberg SX74	775 x 197 mm	100 foil/box
EFOIL257475	Ink Duct Foil for Heidelberg SM74-CD74-XL75	775 x 229 mm	100 foil/box
EFOIL25102	Ink Duct Foil for Heidelberg SM102	1068 x 232 mm	100 foil/box
EFOIL25CD105	Ink Duct Foil for Heidelberg CX/CD102/XL105	1068 x 229 mm	100 foil/box
EFOIL25145	Ink Duct Foil for Heidelberg XL145	1478 x 265 mm	100 foil/box
EFOIL25162	Ink Duct Foil for Heidelberg XL162	1672 x 265 mm	100 foil/box
EFOIL25W8	Ink Duct Foil for WEB 8	548 x 260 mm	50 foil/box
EFOIL25W110	Ink Duct Foil for MC-110	740 x 260 mm	50 foil/box
EFOIL25W130	Ink Duct Foil for WEB 130	994 x 260 mm	50 foil/box
EFOIL25W16	Ink Duct Foil for WEB 16 / M600 w/foam	1002 x 260 mm	50 foil/box
EFOIL25W16S	Ink Duct Foil for Goss M600 w/2 notches, w/foam	1002 x 260 mm	50 foil/box
0.25mm/0.01" FOIL IS FOR EXTREMELY LONG RUNS WITH CONVENTIONAL INK OR SHORT RUNS WITH UV INK			
0.30mm/0.012"			
EFOIL30QM	Ink Duct Foil for Heidelberg QM 46	358 x 200 mm	50 foil/box
EFOIL30GT052	Ink Duct Foil for Heidelberg GT052	547 x 200 mm	50 foil/box
EFOIL30SM52	Ink Duct Foil for Heidelberg SM52	547 x 197 mm	50 foil/box
EFOIL30M0	Ink Duct Foil for Heidelberg MO	676 x 200 mm	50 foil/box
EFOIL3072	Ink Duct Foil for Heidelberg SM72	775 x 232 mm	50 foil/box
EFOIL30SX74	Ink Duct Foil for Heidelberg SX74	775 x 197 mm	50 foil/box
EFOIL307475	Ink Duct Foil for Heidelberg SM74-CD74-XL75	775 x 229 mm	50 foil/box
EFOIL30102	Ink Duct Foil for Heidelberg SM102	1068 x 232 mm	50 foil/box
EFOIL30CD105	Ink Duct Foil for Heidelberg CX/CD102/XL105	1068 x 229 mm	50 foil/box
EFOIL30145	Ink Duct Foil for Heidelberg XL145	1478 x 265 mm	50 foil/box
EFOIL30162	Ink Duct Foil for Heidelberg XL162	1672 x 265 mm	50 foil/box
EFOIL30W8	Ink Duct Foil for WEB 8	548 x 260 mm	50 foil/box
EFOIL30W110	Ink Duct Foil for MC-110	740 x 260 mm	50 foil/box
EFOIL30W130	Ink Duct Foil for WEB 130	994 x 260 mm	50 foil/box
EFOIL30W16	Ink Duct Foil for WEB 16 / M600 w/foam	1002 x 260 mm	50 foil/box
EFOIL30W16S	Ink Duct Foil for Goss M600 w/2 notches w/foam	1002 x 260 mm	50 foil/box

0.30mm/0.012" FOIL IS SPECIFICALLY FOR PRINTING WITH UV INK OR LONG RUNS WITH COARSE INK



# CPC CONSUMABLES

**Code: TESAM**  
00.580.1010

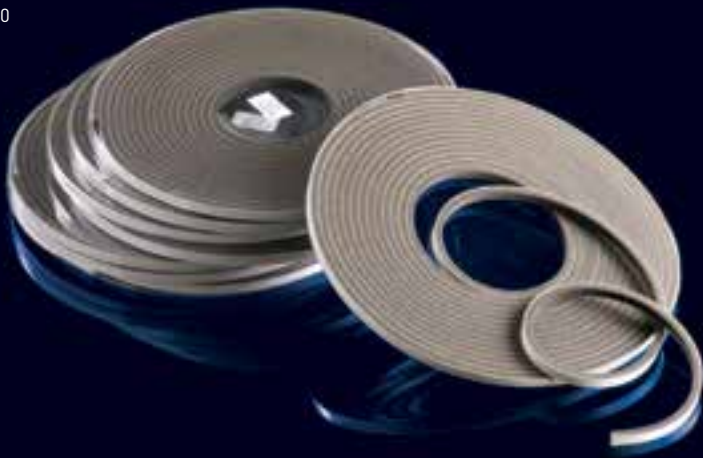

## TESAMOL STRIP

An adhesive foam for placement under the ink duct foil.

Packed in a convenient clear plastic container with perforated opening for easy removal and safe storage.

9mm x 6mm x 10m/roll

**Code: PUNPF Sheet-fed**  
00.472.006



**PUNPFWEB WEB8 & WEB16**  
00.472.0012/0023

## PROTECTIVE UNDERLAY FOIL

A two-band bi-adhesive foil for placement under the ink duct foil.

Packed in a convenient clear plastic container for safe storage.

PUNPF for sheet-fed presses  
Size: 70mm x 25m/roll

PUNPFWEB for WEB 8 & 16  
Size: 95mm x 25m/roll

Also available in rolls of 12 pieces pre-cut to individual press sizes.

**Code: PUNPF52N** 62.82.008.419F/02

**Code: PUNPF7475N** L2.82.008.119F/02

**Code: PUNPF102105N** 82.008.119F

**Code: PUNPF145N** 66.008.159F

**Code: PUNPF162N**



## NEW PROTECTIVE UNDERLAY FOIL

New style protective underlay foil with bi-adhesive tape and hard edge profile for easy fit.

**Packing: 12 pieces/box**

PUNPF52N for SM52  
Size: 90mm x 547mm

PUNPF7475N for SM74/CD74/XL75  
Size: 90mm x 775mm

PUNPF102105N for SM102/CX-CD102/XL105  
Size: 90mm x 1068mm

PUNPF145N for XL145  
Size: 90mm x 1478mm

PUNPF162N for XL162  
Size: 90mm x 1672mm

# Ink Duct End Blocks

for Heidelberg Presses and Kompac Systems

## Cleaning Felts



*Master* ink duct end blocks are made of the highest quality engineering grade plastic polymer (POM) which can endure high cyclic stress loading. This ensures high strength and wear resistance translating into a long life in production.

*Master* ink duct end blocks are precision engineered on modern CNC machines ensuring an exceptional tight fit to the ink duct roller.

*Master* ink duct end blocks are, wherever required, supplied with tab, screw and scraper cleaner mounted and ready to use.

# INK DUCT END BLOCKS FOR HEIDELBERG

**Code: IBQM46** AI.008.104/01

**Model: Heidelberg QM46**

Packing: 1 pair/bag

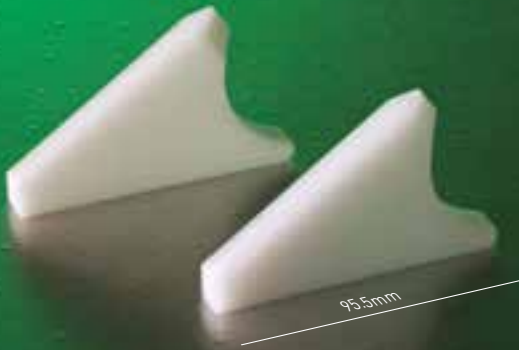

**Code: IBQM46DI**

A4.008.323 - O/S A4.008.324 - D/S

**Model: Heidelberg QM46-DI**

Packing: 1 pair/bag

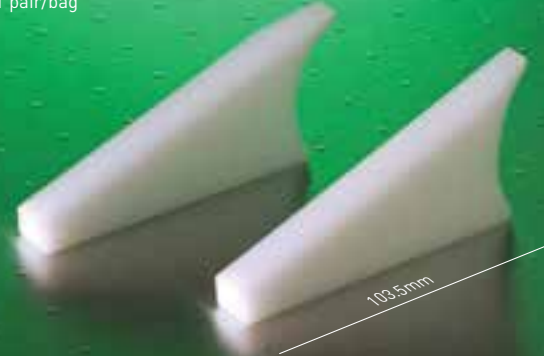

**Code: IBGT00A** 69.008.012

**Model: Heidelberg GT052 without CPT**

Packing: 1 pair/bag

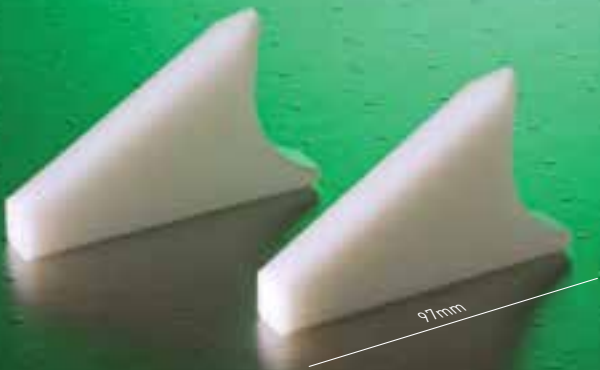

**Code: IBGT00B** MV.037.346

**Model: Heidelberg GT052 without CPT**

Packing: 1 pair/bag



**Code: IBGT00C** MV.022.805

**Model: Heidelberg GT052 with CPC and CPT**

Packing: 1 pair/bag



**Code: IBWEB** 5E.008.216

**Model: Heidelberg WEB8/WEB12/WEB16/Harris M600**

Packing: 1 pair/bag





# INK DUCT END BLOCKS FOR HEIDELBERG

## Code: IBSM52CC

G2.008.113 F/ - OS G2.008.112 F/ - D/S

Model: Heidelberg SM52 with CPC and CPT

Packing: 1 pair/bag



## Code: IBSM520

G2.008.309 - DS G2.008.310F - OS

Model: Heidelberg SM52

without CPC and CPT

Packing: 1 pair/bag



## Code: IBM02 43.008.021/02

Model: Heidelberg M0 S/N 608117+

Packing: 1 pair/bag



## Code: IBM0 63.008.113

Model: Heidelberg M0

Packing: 1 pair/bag



## Code: IB74 M2.008.113F/02

Model: Heidelberg SM74/PM74

Packing: 1 pair/bag



## Code: IBSM748113 M1.008.113

MV.016.780/01 - OS MV.016.778/01 - DS

Model: Heidelberg SM74 without CPC

Packing: 1 pair/bag



**Code: IB74CD**

L2.008.114F - O/S L2.008.113F - D/S

**Model: Heidelberg CD74/XL75**

Packing: 1 pair/bag



**Code: IB102/72** MV.025.468

91.008.013/91.008.014

**Model: Heidelberg CD102/SM102/SM72**

Packing: 1 pair/bag



**Code: IB105**

F2.008.109 - F2.008.110

**Model: Heidelberg XL105/XL106**

Packing: 1 pair/bag

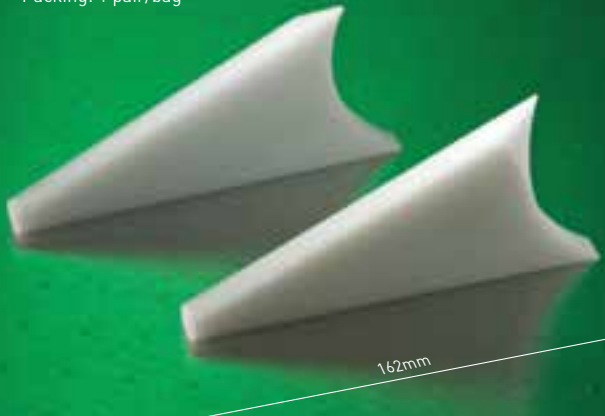

**Code: IB162**

G7.008.113/04 - G7.008.114/04

**Model: Heidelberg XL145/XL162**

Packing: 1 pair/bag

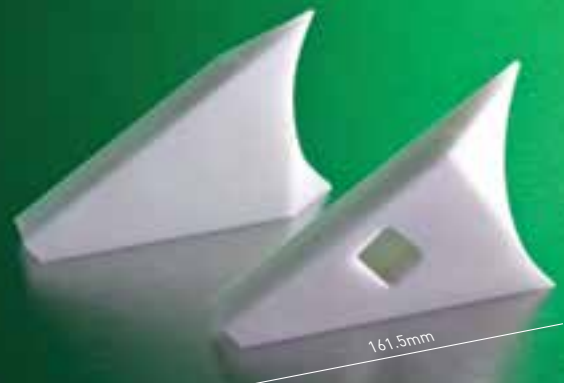

**INK DUCT END BLOCKS FOR KBA**

**Code: IBKBA105**

**Model: KBA105**

Packing: 1 pair/bag



**GOSS**

**Code: IBM600** 4ME008145 4ME008146

**Model: Goss M600**

Packing: 1 pair/bag



## DUCT INSULATING STRIPS

A bi-adhesive for placement under the edge of the ink duct end block.

**Code: DUCT10** 91.008.044/A

10 pcs/pack @150mm x 16mm

**Code: DUCT150**

150 pcs/pack @150mm x 16mm

**Code: IBTAB**

Left and right spare tabs with screws  
1 set with screws/bag



## SCRAPER CLEANERS

**Code: SCSHEET** 91.008.033

For ink duct end blocks on Heidelberg sheet fed presses.

Packing: 25 pcs/bag



**Code: SCWEB16**  
WM4ME008054

For ink duct end blocks on Heidelberg WEB16  
Packing: 25 pcs/bag

## HEIDELBERG DAMPENING SEALS

**Code: SEAL46PM** MV.034.739

**Model: Heidelberg PrintMaster 46**

Description: Dampening seals

Packing: 1 set (DS/OS)



**Code: SEAL46QM** MV.027.163

**Model: Heidelberg QuickMaster 46**

Description: Dampening seals

Packing: 1 set (DS/OS)



## KOMPAC DAMPENING SEALS

**Code: IBVKSMP** 92370

Teflon seals for Kompac II system

For small offset press including: Ryobi, AB Dick, Adast Dominant, Chief, Gestetner, Hamada, Multilith, Rotaprint and Sakurai

Packing: 1 pair/bag



**Code: IBVKGTO** 90850

Teflon seals for Kompac III system, GT046/52, MO and Practika 00/01

Packing: 1 pair/bag



# HEIDELBERG

# CLEANING FELTS



**Code: FELTPM46**

Cleaning felt for PM46  
Size: 360 x 30 x 3 mm  
Packing: 5 pcs/pack

**Code: FELTQM46**

Cleaning felt for QM46  
Size: 360 x 37 x 3 mm  
Packing: 5 pcs/pack

**Code: FELTQM46DI**

Cleaning felt for QM DI 46  
Size: 360 x 70 x 4 mm  
Packing: 5 pcs/pack

FELTQM46DI

FELTQM46

FELTPM46

# KBA

**Code: FELTKBA1**

Cleaning felt for KBA RAPIDA 74  
Packing: 20 pcs/pack

**Code: FELTKBA2**

Cleaning felt for KBA 104/105  
Packing: 20 pcs/pack

**Code: FELTKBA3**

Cleaning felt for KBA 142/162  
Packing: 20 pcs/pack

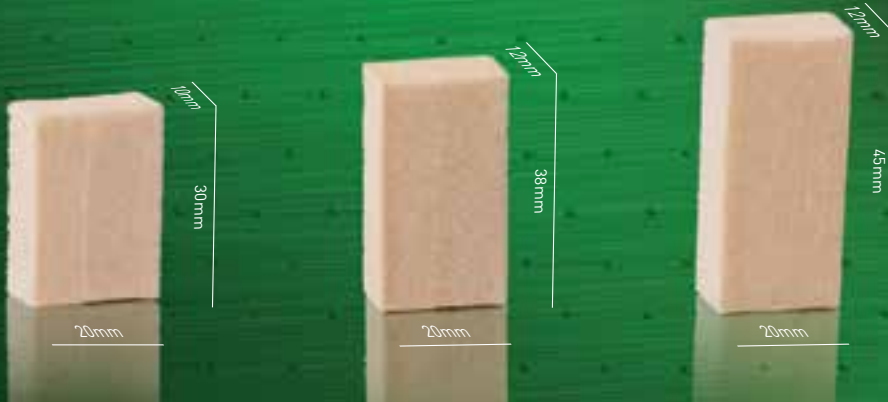

# HARRIS

**Code: FELTM600**

Cleaning felt for Harris M600  
Packing: 20 pcs/pack

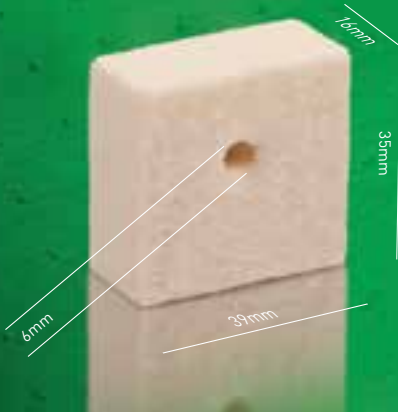

*Our range of wash-up bottles can be found on page 76 in the Miscellaneous section!*



## KOMORI

**Code: FELTK04**

Cleaning felt for Komori Lithrone 28  
Packing: 20 pcs/pack

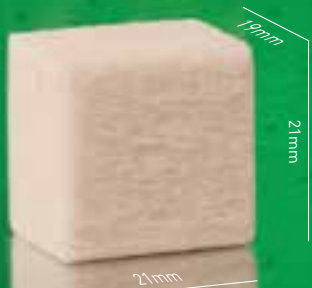

**Code: FELTK05** 374-9608-401

Cleaning felt for Komori  
Packing: 20 pcs/pack



## KOMPAC

**Code: FELTVKSMP** 93930

Cleaning felt for Kompac II Systems  
Packing: 25 pcs/bag



**Code: FELTVKGTO** 94900

Cleaning felt for Kompac III Systems  
Packing: 25 pcs/bag



## MITSUBISHI

**Code: FELTMIT3F**

Cleaning felt for Mitsubishi 3F  
Packing: 20 pcs/pack

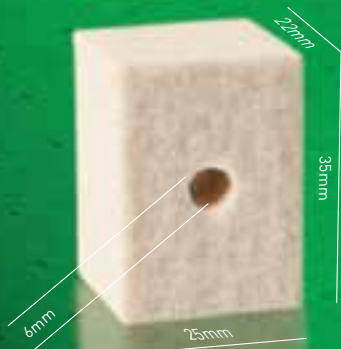

**Code: FELTMIT6F**

Cleaning felt for Mitsubishi 6F  
Packing: 20 pcs/pack

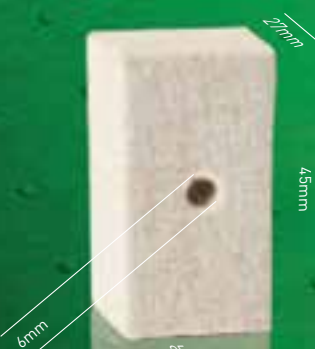

*Find the new Universal Seal for Tresu D2 chambers and*



*our new Steel and Brass Brushes for cleaning anilox rollers are on page 61*

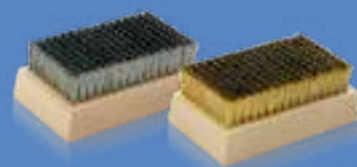



# PERFORMANCE

Non-Woven wash cloth

Master Performance is a premium non-woven wash cloth specifically developed for automatic blanket cleaning systems.

Highly absorbent yet incredibly strong, Performance wash cloth removes ink, dust and impurities from the blanket quickly and completely in one safe operation without distorting or tearing under tension.

Performance cloth provides an unbeatable combination of competitive prices and excellent qualities such as:

- high tear resistance
- high absorbency
- virtually lint free
- non scratching
- effective and efficient cleaning

**A perfect dot needs a clean surface!**



## PERFORMANCE MINI ROLLS

Each Performance mini-roll is precisely made for an exact fit giving a superior cleaning performance.

Each roll is manually inspected to ensure sharp shoulders, straight edges and correct circumference. The rolls are then packed in extra strong double sided corrugated boxes.



## JUMBO ROLLS

500M jumbo rolls are available for in-house re-winding of mini-rolls.

Supplied in many sizes for all printing machines with automatic blanket cleaning systems.

Request a price list for our complete range.



## TECHNICAL DATA

Performance cloth is specifically developed for Automatic Blanket Cleaning systems. It is manufactured with a mix of 55% cellulose and 45% polyester fibers utilizing a high pressure hydro-entanglement process.



## WET ROLLS

Performance wet rolls are available in all standard sizes for:

Sheet-Fed Presses: Akiyama, Fuji- Shinohara, Heidelberg, KBA, Komori, Mitsubishi, Oliver Sakurai, Roland and Ryobi.

Web Presses: Goss, Heidelberg, Komori, MAN and Mitsubishi.

*A* MasterPRODUCT

# Recirculation Filters

Over 1 million recirculation filters sold!

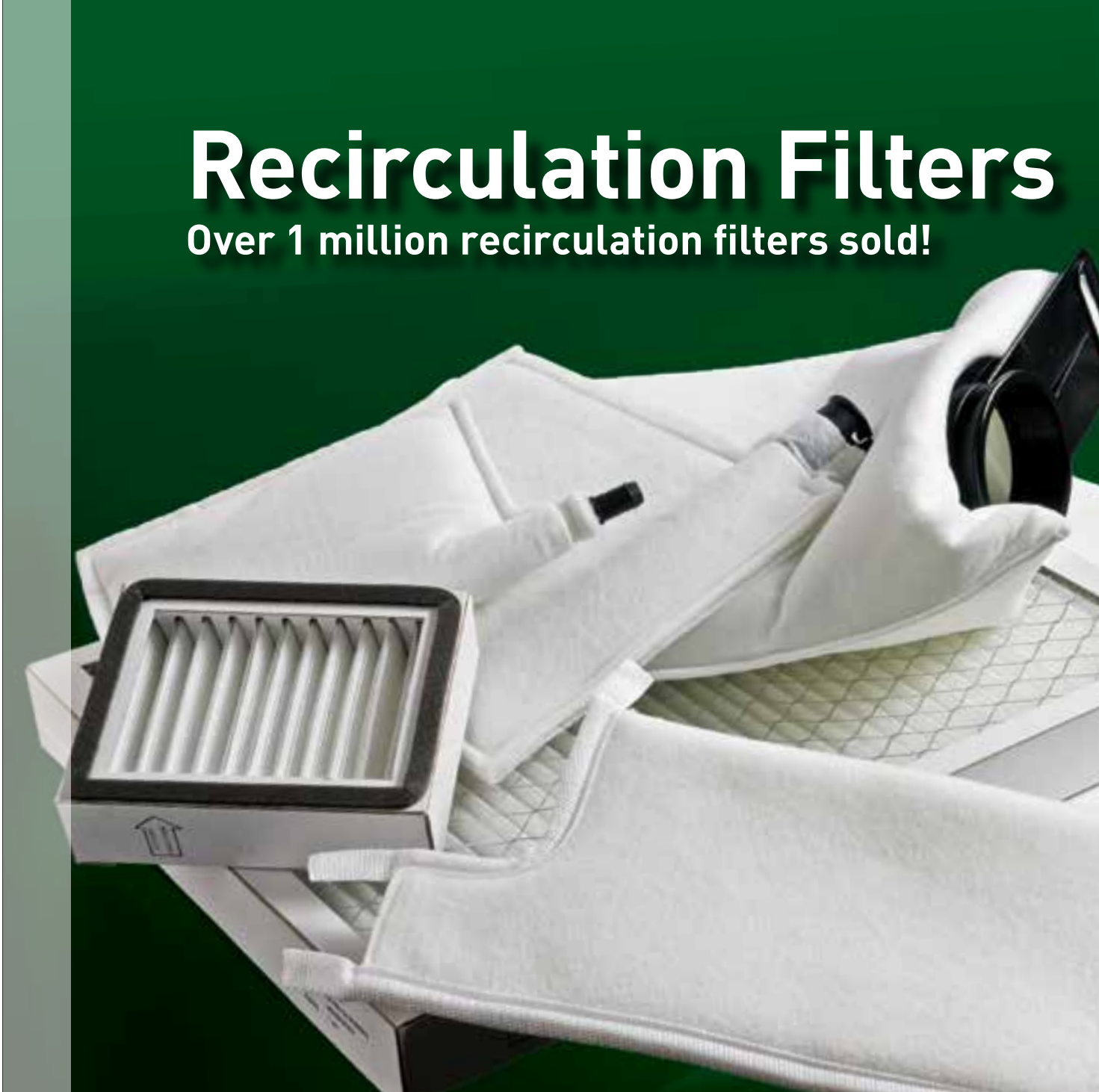

We work hard to produce high quality, high value products which enable presses everywhere to run more efficiently.

Our long line of replacement and custom designed re-circulation filters are tough, long lasting – and guaranteed to meet or exceed every printer's expectations.

*Master* filters of which several models are made with multi-layer design, remove most contaminants ensuring a consistently cleaner fount, improving accurate monitoring of fount conductivity, thereby reducing down time and giving long press runs and less maintenance.

Made in high quality felt, polyester or nylon, Master recirculation filters are carefully fabricated and come with a wide assortment of fittings ensuring ease of installation and compatibility with most press models on the market.

All *Master* filters undergo extensive field testing and provide a high contaminant loading and long service life.



## RECIRCULATION FILTERS

### Code: FILTER01

For Royse systems. Also widely used on all types of Heidelberg, Komori and Roland presses where a hose can easily be fitted to return-flow.

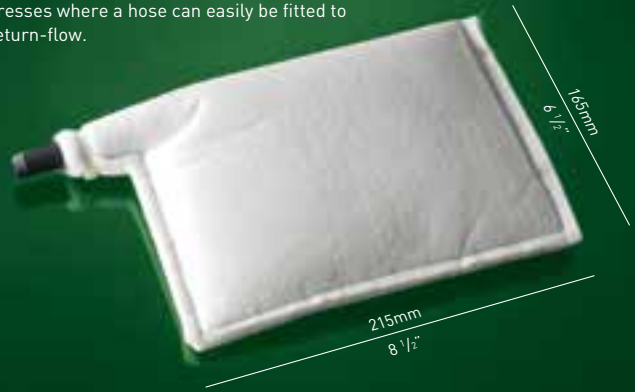

### Code: FILTER02

For Master Flow systems. Also used on some Royse systems.



### Code: FILTER03

For Technotrans systems (old style)



### Code: FILTER04

For Technotrans systems (new style) and MG Electric Eco

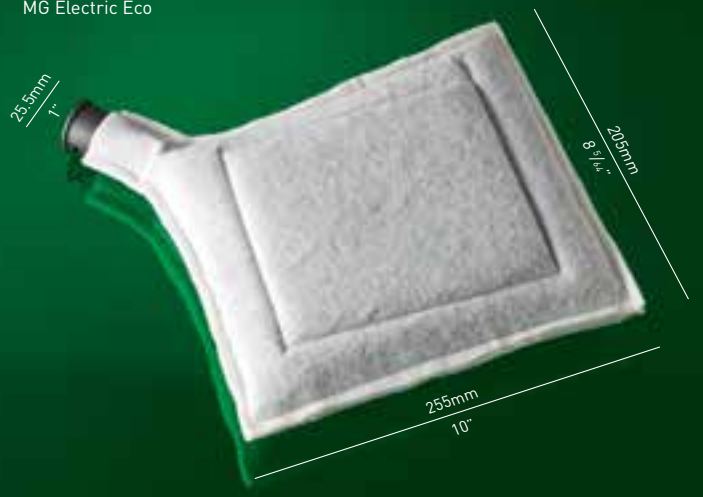



# RECIRCULATION FILTERS

Code: **FILTER05**



Code: **FILTER06**

For Technotrans Alpha D systems fitted to Heidelberg, Komori, Roland and various other presses. Can also be used on Baldwin units which have similar neck fitting.



Code: **FILTER07**

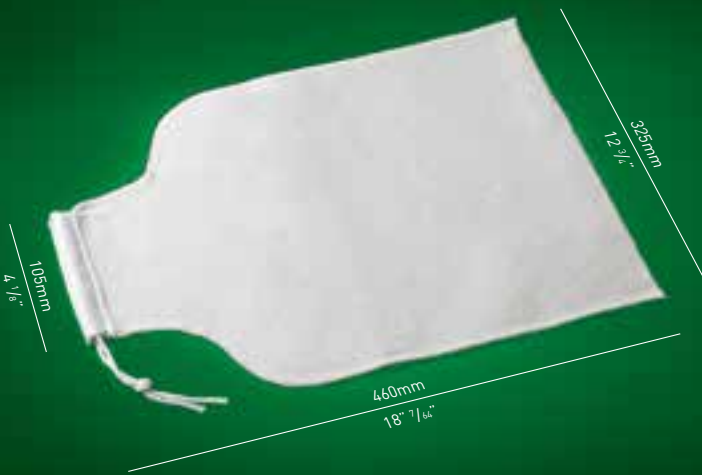

Code: **FILTER08**

Technotrans



Code: **FILTER09**

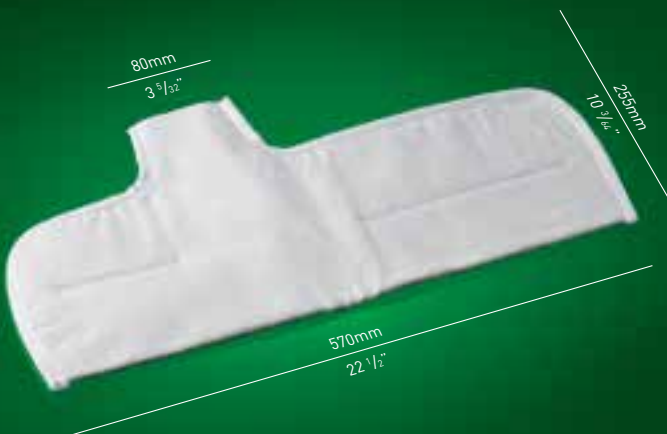

Code: **FILTER10**



**Code: FILTER11**

For Technotrans systems



**Code: FILTER12**



**Code: FILTER13**

For Technotrans and other systems

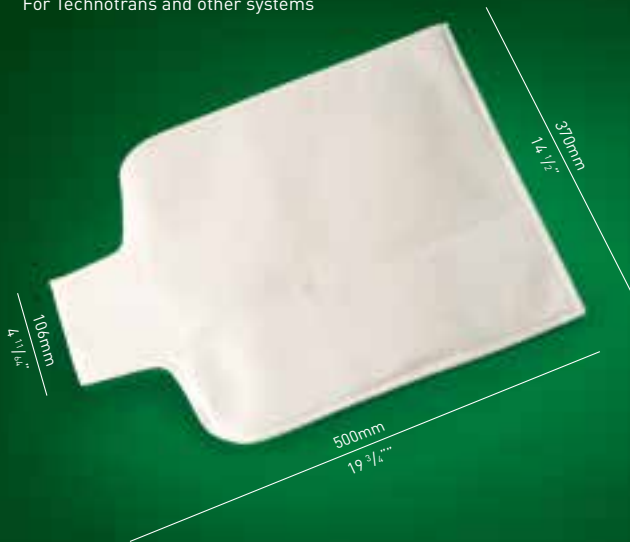

**Code: FILTER14**

For Royce systems



**Code: FILTER15**

For Baldwin (KBA/Planeta)



**Code: FILTER16**

Outer material nylon



# RECIRCULATION FILTERS

**Code: FILTER17**

Outer material felt



**Code: FILTER18**



**Code: FILTER19**



**Code: FILTER20**

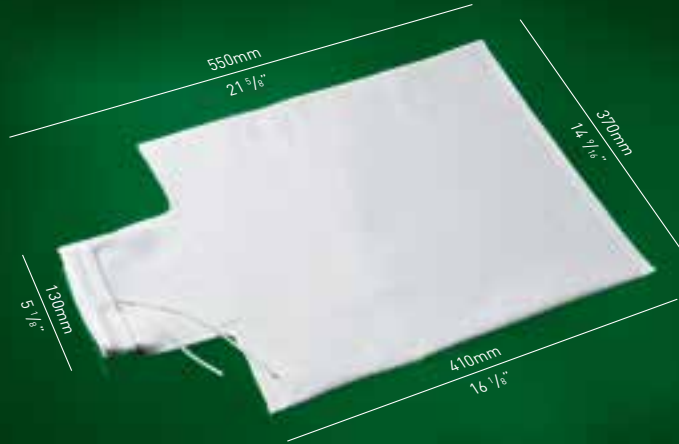

**Code: FILTER21**

Technotrans Delta C

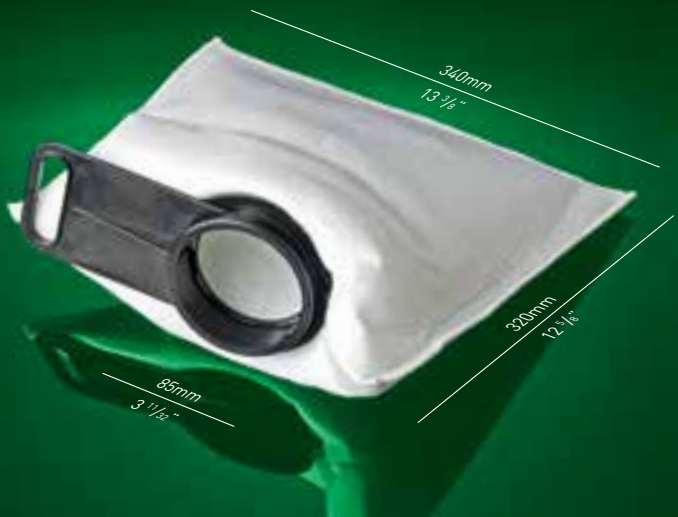

**Code: FILTER22**



**Code: FILTER28** L6.187.2125/01

For Technotrans systems



**Code: FILTER29**



Note:  
Avoid mistake between  
FILTER15 and FILTER29.  
FILTER15 is 10mm shorter  
and the most popular size.

## ELIMINATOR



### Removes emulsified ink!

The Eliminator is a durable nylon-mesh bag filled with ink absorbent material which effectively prevents contamination of the dampening system.

Simply place the Eliminator in the circulation tank and it will float on the surface of the fountain solution removing all emulsified ink.

Size: 200x115x25mm 8"x4 1/2"x1"

Packing: 8 pcs/box

# FILTER MATS



## Code:

<b>FM152 x 340</b>	6" x 13 25/64"
<b>FM152 x 465</b>	6" x 18 5/16"
<b>FM170 x 470</b>	6 11/16" x 18 1/2"
<b>FM180 x 280</b>	7 3/32" x 11"
<b>FM190 x 290</b>	7 31/64" x 11 27/64"
<b>FM200 x 280</b>	7 7/8" x 11"
<b>FM200 x 310</b>	7 7/8" x 12 13/64"
<b>FM200 x 320</b>	7 7/8" x 12 19/32"
<b>FM200 x 400</b>	7 7/8" x 15 3/4"
<b>FM200 x 440</b>	7 7/8" x 17 21/64"
<b>FM240 x 710</b>	9 29/64" x 27 61/64"
<b>FM250 x 250</b>	9 29/64" x 9 29/64"
<b>FM250 x 300</b>	9 27/32" x 11 13/16"
<b>FM250 x 330</b>	9 27/32" x 13"
<b>FM250 x 400</b>	9 27/32" x 15 3/4"
<b>FM250 x 470</b>	9 27/32" x 18 1/2"
<b>FM250 x 670</b>	9 27/32" x 26 3/8"
<b>FM255 x 635</b>	10 3/64" x 25"
<b>FM275 x 470</b>	10 53/64" x 18 1/2"
<b>FM275 x 780</b>	10 53/64" x 30 45/64"
<b>FM300 x 400</b>	11 13/16" x 15 3/4"
<b>FM305 x 1150</b>	12" x 45 9/32"
<b>FM315 x 660</b>	12 13/32" x 26"
<b>FM360 x 360</b>	14 11/64" x 14 11/64"
<b>FM400 x 400</b>	15 3/4" x 15 3/4"
<b>FM400 x 900</b>	15 3/4" x 35 7/16"
<b>FM470 x 500</b>	18 1/2" x 19 11/16"
<b>FM500 x 500</b>	19 11/16" x 19 11/16"
<b>FM500 x 750</b>	19 11/16" x 29 17/32"
<b>FM 30M x 1M</b>	118 7/64" x 39 3/8"

Packing: 4 pcs/pack

# MISTING FILTERS

## Code: **FILTERMIST01** F4.010.102/02A

Misting filter for Heidelberg XL105

Size 1060 x 120 x 20mm

41 47/64" x 4 23/32" x 25/32"

Packing: 6 pcs/pack 2 packs/box

## Code: **FILTERMIST02** F4.010.214/F

Misting filter for Heidelberg XL106

Size: 1155 x 365 x 20mm

45 1/2" x 14 1/2" x 25/32"

Packing: 6 pcs/pack 2 packs/box



# Master Anti-Marking Systems

The Master anti-marking film and paper is coated with a uniform layer of over 2500 microscopic silicon glass beads per sq/cm.

The ink repellent glass beads prevent ink smearing on the transfer cylinders and ensure that only the smallest possible area is in direct contact with the wet ink during transfer of the printed sheet. The net result is less marking and much less down time.

Bonded to the backing substrate with a hardened polyurethane adhesive both the anti-marking film and paper are resistant to ink, oil, standard press wash-up solvents and water.

## Anti-Marking Paper

This oil impregnated, dimensionally stable paper, offers the most economical solution to problems with marking.

**Universal Model**  
Code: AMP  
Size/roll: 1150mm x 20m  
Packing: 4 rolls/carton

## Anti-Marking Film

The premium quality anti-marking product with polyester backing. Extremely durable and favored by most printers. Available in two models:

**Fine** Code: AMF  
**Coarse** Code: AMFC  
Size/roll: 1150mm x 50m  
Packing: 1 roll/carton

## Anti-Marking Film Self-Adhesive

Also with polyester backing but with the added benefit of a self-adhesive backing for quick and easy installation. Available in two models:

**Fine** Code: AMFA  
**Coarse** Code: AMFAC  
Size/roll: 1050mm x 25m  
Packing: 1 roll/carton

### Easy Installation:

Installation is simple:  
Clean the surface of the transfer and delivery cylinders.

Smooth the film onto the cylinders using either the:

- self-adhesive backing of the AMF-A or
- in case of the AMP paper or AMF film by using double sided adhesive tape or spray-on adhesive.

No press modifications are necessary.

### Quick Cleaning:

To keep the AMF and AMP in perfect running condition occasionally wipe it down with a rag wetted with a mild or diluted press wash solution.

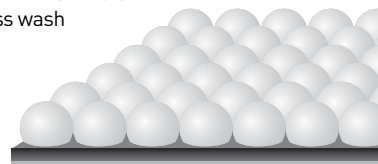

Red cylinders indicate a typical installation of anti-marking film or paper.

### Universal Application:

The AMF and AMP can be used by all commercial printers on both coated and non-coated paper, from light to heavy stock.

- Long lasting top quality anti-marking system at affordable price
- Simple, cost effective alternative to other anti-marking products and air drums
- Prevents costly wasted sheets due to ink build-up on transfer and delivery cylinders
- Quick and easy to install - no press modifications or cylinder surface treatments needed
- Resistant to ink, oil, standard press wash-up solvents and water
- Uniform thickness - dimensionally stable base substrate

**For more Anti-Marking products please enquire about our:**

- Anti-Marking Nets
- Anti-Marking Jackets
- Anti-Marking Paste

# Cabinet Air Filters

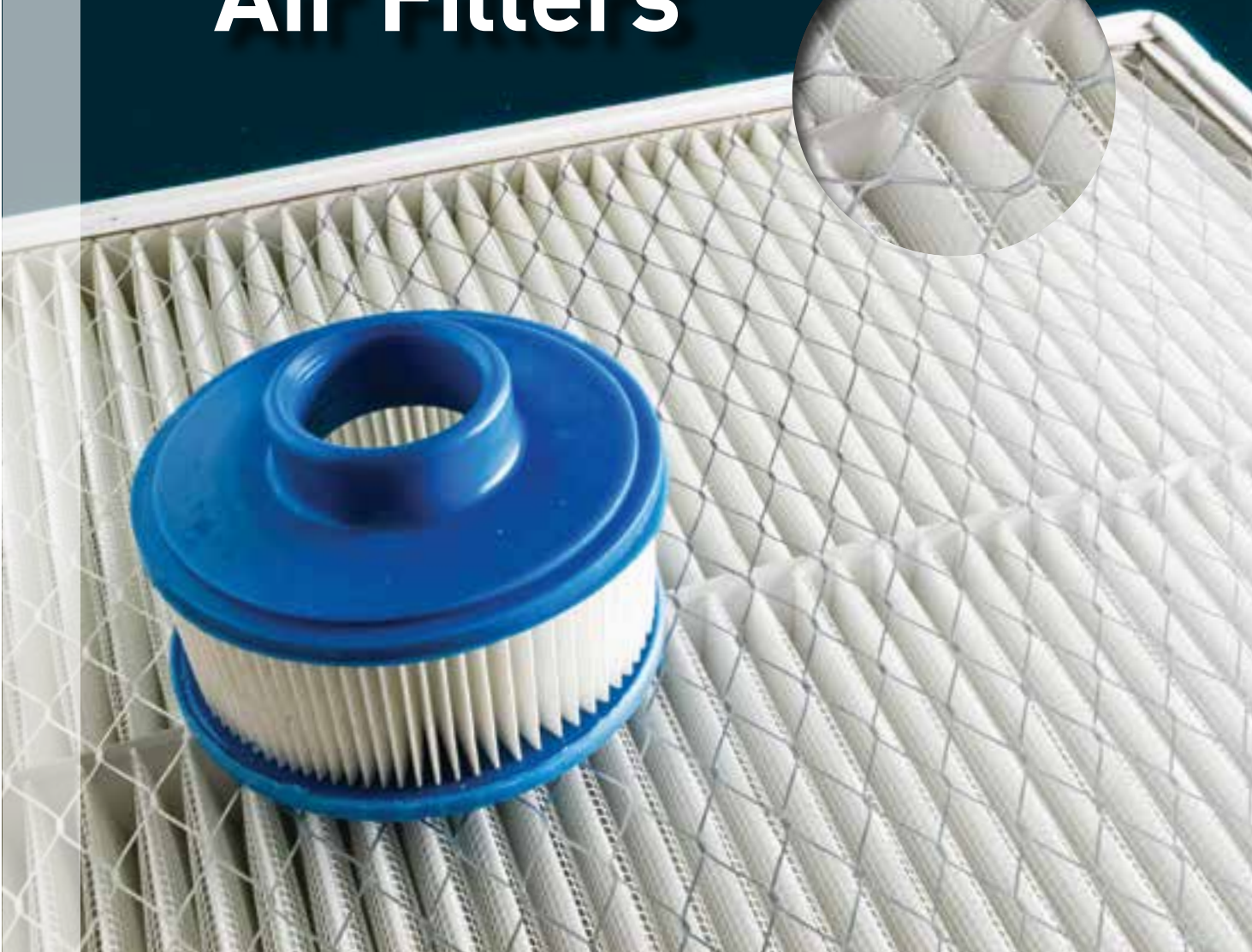

AIR FILTERS

22

AIR FILTERS

**Code: AFH3702** 00.780.3702

Description: Air filter for spray powder unit  
SORM/SORD/SORS/MO/SM102/CD102

Packing: 1 piece

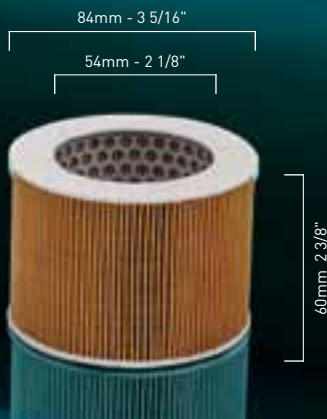

**Code: AFH8106** 47.018.106

Description: Air filter for SM74/CD74/SM102/  
CD102/SX/CX/XL

Packing: 1 piece



**Code: AFH4992** 00.580.4992

Description: Air filter for SM/CD/CX/SX/XL presses

Packing: 1 piece



# AIR FILTERS

**Code: AF170140**

Size: 170x140x47mm  
6 11/16 x 5 33/64 x 1 27/32"



**Code: AFH5379** 00.580.5379

Large air filter for Heidelberg

129mm - 5 1/16"  
44mm - 1 47/64"



80mm 3 5/32"

Old Code: AIRFILTHL

**Code: AFH6146** 00.580.6146

Small air filter for Heidelberg

43mm - 1 11/16"  
20mm - 25/32"



89mm 3 1/2"

Old Code: AIRFILTHS

**Code: AF750480**

Size: 750 x 480 x 47mm - 29 17/32 x 18 57/64 x 1 3/4"



**Code: AF730160** 00.580.5832

Size: 730 x 160 x 47mm - 28 47/64 x 6 19/64 x 1 3/4"



**Code: AF700140** C2.102.1911

Size: 700 x 140 x 47mm - 27 9/16 x 5 33/64 x 1 3/4"

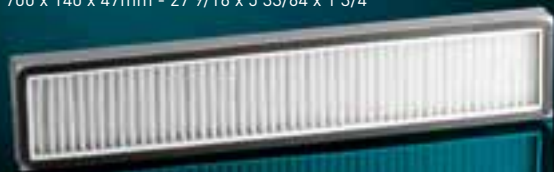

**Code: AF495394** F2.179.1821

Size: 495 x 394 x 45mm - 19 31/64 x 15 33/64 x 1 3/4"



**Code: AF650400** FS.102.3801/02

Size: 650 x 400 x 47mm - 25 9/16" x 15 3/4" x 1 3/4"





# Feeder Belts and Slow Down Belts

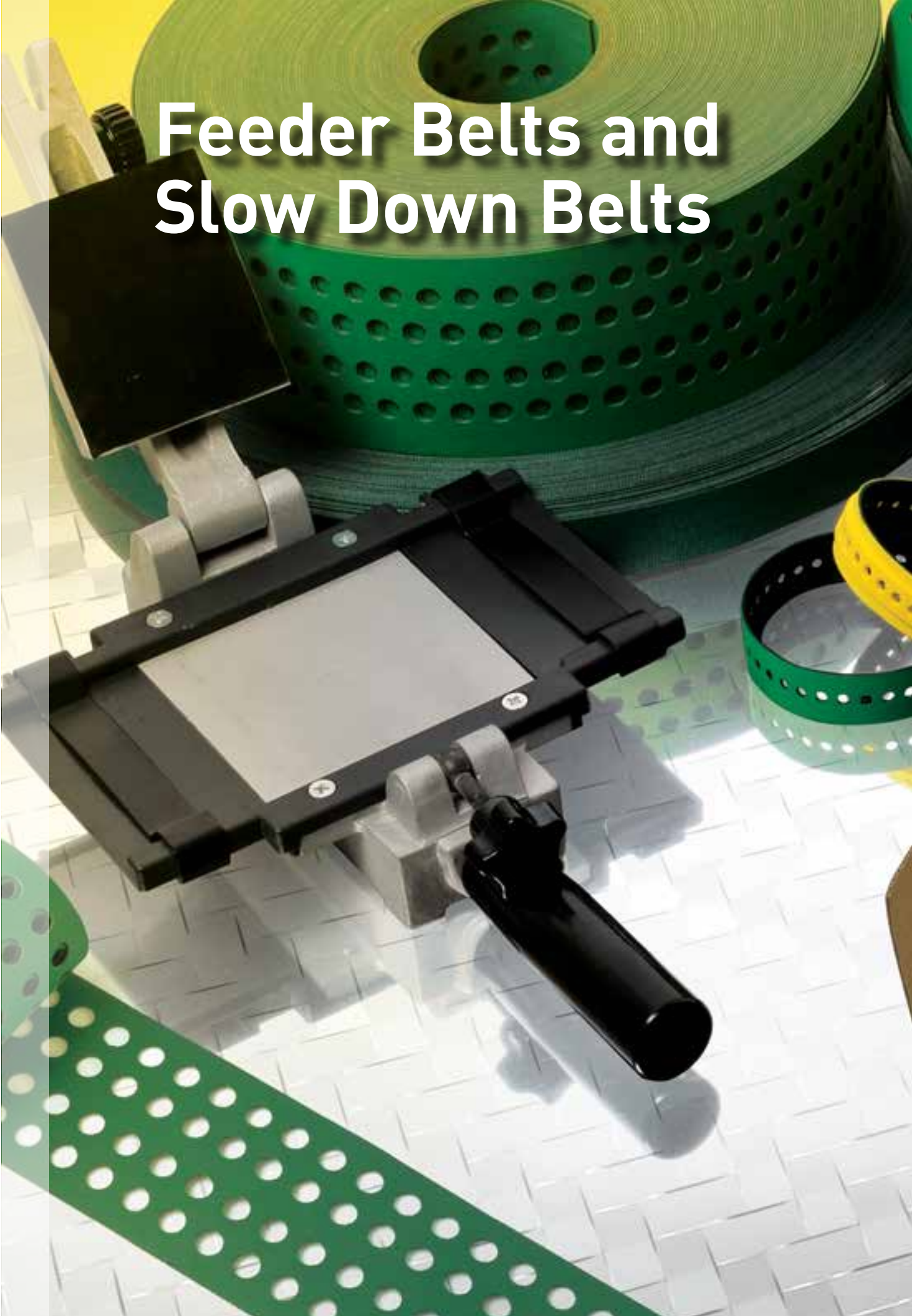



Quality belts for the printing industry!

Using the best materials available and state-of-the-art manufacturing equipment our team of professionals can assure you of a superb product.

*Master* Belts are found throughout the printing industry handling the most demanding belt applications.

We supply all types of belts elastomer, wear resistant polyurethane, woven endless, self tracking, vacuum, with or without carcass, covered, sealed, fused and anti-static you name it and we can make it to your specifications.

Our computerized punching machines can make almost any pattern of round perforations for vacuum belts and other shapes may be available with extra charge for tooling or special die.

Let us work with you toward a profitable, top quality product guaranteed to meet your highest expectations.

# HEIDELBERG

FEEDER BELTS

26

FEEDER BELTS

**Code: FB102** 86.020.029

**Model: Heidelberg SM102/72**

Size: 2015 x 28mm/79 21/64" x 1 7/64"

Packing: 1 piece

**Code: FBSOZ** 66.020.029

**Model: Heidelberg SORKZ/SORMZ/SORDZ**

Size: 2015 x 28mm/79 21/64" x 1 7/64"

Packing: 1 piece

**Code: FBSO** 66.020.080/F

**Model: Heidelberg SORK/SORM/SORD**

Size: 1465 x 28mm/57 43/64" x 1 7/64"

Packing: 1 piece

**Code: FBMO** 53.020.029

**Model: Heidelberg MO**

Size: 1375 x 25mm/54 9/64" x 63/64"

Packing: 1 piece

**Code: FB52** 89.020.007

**Model: Heidelberg GT052 - Perforated**

Size: 1220 x 89mm/48 1/32" x 3 1/2"

Packing: 1 piece

**Code: FBSM52** G2.020.009

**Model: Heidelberg SM52 - Endless**

Size: 950 x 60mm/37 13/32" x 2 23/64"

Packing: 1 piece



**Code: FB74**

**Model: Heidelberg SM74**

Description: One set comprising:  
1 piece FB74N & 1 piece FB74P

Packing: 1 set/box



M2.020.017

**Code: FB74N**

**Model: Heidelberg SM74**

Size: 1265 x 54mm/49 3/4" x 2 1/8"

Packing: 1 piece



**Code: FB74P** M2.020.017

**Model: Heidelberg SM74 - Perforated**

Size: 1265 x 54mm/49 3/4" x 2 1/8"

Perforated

Packing: 1 piece



**Code: FB102105** F4.020.292/02

**Model: SM102/CD102/XL105 - Endless**

Size: 2890 x 210mm/113 25/32" x 8 17/64"

Packing: 1 piece



**Code: FBCD74** L2.020.014

**Model: Heidelberg SM74/CD74/XL75 - Endless**

For post 2006 presses

Size: 2428 x 138mm/95 19/32" x 5 7/16"

Packing: 1 piece



**Code: FB741410**

**Model: Heidelberg SM74 - Endless**

Size: 1410 x 85mm/55 1/2" x 3 11/32"

Packing: 1 piece

## AKIYAMA

**Code: FBAB28**

**Model: Akiyama Bestech 28**

Size: 1660 x 28mm/65 23/64" x 1 7/64"

Packing: 1 piece



## RYOBI

**Code: FBRYOBI**

**Model: Ryobi 755 - Perforated**

Size: 1780 x 50mm /70 5/64" x 1 31/32"

Packing: 1 piece



## KBA

**Code: FBKBA104**

**Model: KBA Rapida 104/105**

Size: 2627 x 28mm/103 27/64" x 1 7/64"

Packing: 1 piece

**Code: FBKBA142**

**Model: KBA Rapida 142/162**

Size: 3185 x 40mm/125 25/64" x 1 5/8"

Packing: 1 piece

**Code: FBKBAP1**

**Model: KBA Rapida - Perforated**

Size: 2060 x 80mm/81 7/64" x 3 5/32"

Packing: 1 piece

**Code: FBKBAP2**

**Model: KBA Rapida 142/162 - Perforated**

Size: 3160 x 80mm/124 13/32" x 3 5/32"

Packing: 1 piece

**Code: FBKBAP3**

**Model: KBA Rapida 142/162 - Perforated**

Size: 3190 x 100mm/125 19/32" x 3 15/16"

Packing: 1 piece



## KOMORI



---

**Code: FBKS26**

**Model: Komori Sprint 26"**

Size: 1448 x 28mm/57 x 1 7/64"

Packing: 1 piece

---

**Code: FBKL26**

**Model: Komori Lithrone 26"**

Size: 1680 x 25mm/66 9/64" x 63/64"

Packing: 1 piece

---

**Code: FBKL28**

**Model: Komori Lithrone 28"**

Size: 1975 x 25mm/77 3/4" x 63/64"

Packing: 1 piece

---

**Code: FBKL40**

**Model: Komori Lithrone 40"**

Size: 2400 x 25mm/94 1/2" x 63/64"

Packing: 1 piece

## MITSUBISHI



---

**Code: FBMIT3FE**

**Model: Mitsubishi 3F/E**

Size: 1980 x 25mm/77 61/64" x 63/64"

Packing: 1 piece

---

**Code: FBMIT3G4**

**Model: Mitsubishi 3G-4**

Size: 2205 x 25mm/86 13/16" x 63/64"

Packing: 1 piece

---

**Code: FBMIT3F6**

**Model: Mitsubishi 3F-6**

Size: 2345 x 25mm/92 21/64" x 63/64"

Packing: 1 piece

---

**Code: FBMIT4G5**

**Model: Mitsubishi 4G-5**

Size: 2465 x 25mm/97 3/64" x 63/64"

Packing: 1 piece



### Code: FB0B

**Model: Roland OB**

Size: 1356 x 28mm/53 25/64" x 1 7/64"

Packing: 1 piece

### Code: FB3B

**Model: Roland Rekord 3B**

Size: 1977 x 28mm/77 53/64" x 1 7/64"

Packing: 1 piece

### Code: FB600

**Model: Roland 600**

Size: 1500 x 28mm/59 1/16" x 1 7/64"

Packing: 1 piece

### Code: FBOBP

**Model: Roland OB - Perforated**

Size: 1356 x 50mm/53 25/64" x 1 31/32"

Packing: 1 piece

### Code: FB200

**Model: Roland 200 - Perforated**

Size: 1440 x 50mm/56 11/16" x 1 31/32"

Packing: 1 piece

### Code: FB300

**Model: Roland 300 - Perforated**

Size: 1070 x 50mm/42 1/8" x 1 31/32"

Packing: 1 piece

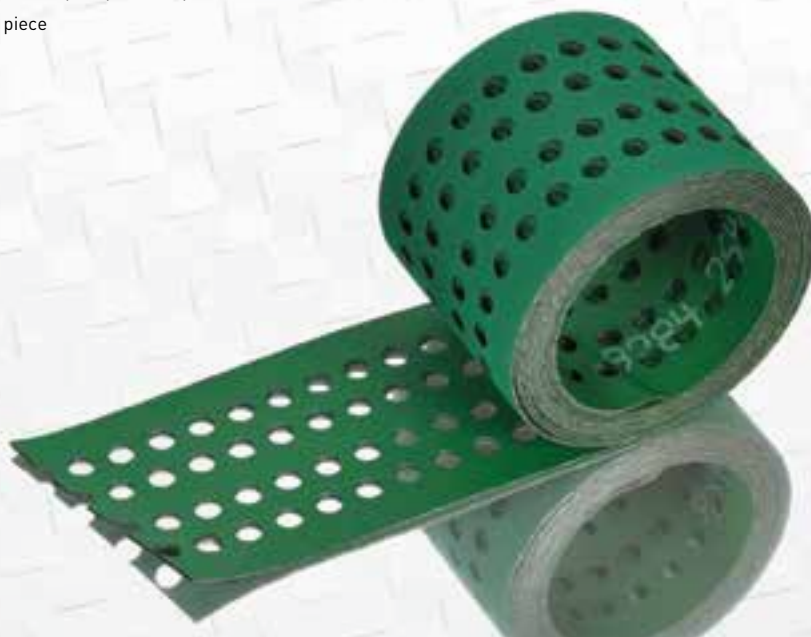
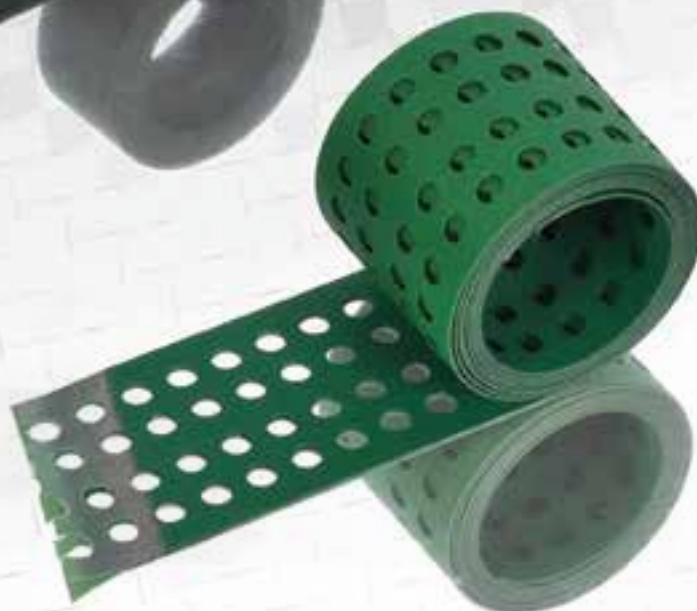

### Code: FB700

**Model: Roland 700 - Perforated**

Size: 2880 x 80mm/113 25/64" x 3 5/32"

Packing: 1 piece

# BELT GLUING UNIT

**Code: KADH**

**Strong glue for belts**

10ml/bottle - 15 bottles/box

## BELT *Master* BELT GLUING UNIT

**Code: BMGM**

- For belt width up to 90mm/3 1/2"
- Even heat distribution
- Automatic temperature regulation
- Light, handy and easy to use

### UNIQUE PACKAGING

**HEIDELBERG M0**  
**Code: FBM0**



For easy handling and safe storage with clear, precise labeling detailing product code, press model, length and width.

### PERFECT SKIVING

**HEIDELBERG SM74**  
**Code: FB74N**

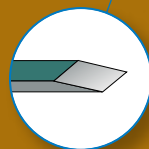

For accurate and easy assembly!

### PERFORATED BELTS

**HEIDELBERG SM52**  
**Code: FBSM52**

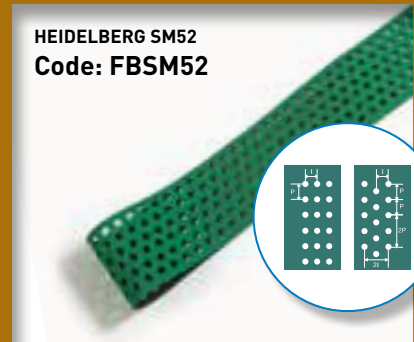

Perforations enable the belts to have air suction ensuring the material is conveyed as intended and also allows for cooling air to pass through.

Examples of precise perforation patterns. Perforations can be executed according to customer's specifications.



# SLOW DOWN BELTS - HEIDELBERG

**Code: FB74SSFG** M2.015.881F/

**Model: SM102/CD102/XL105**

Description: Grey/Flat

Size: 225 x 20mm

Packing: 1 piece



**Code: FB74SSG** M2.015.843F/

**Model: SM52/SM74/XL75/SM102/XL105**

Description: Grey/9mm raised

Size: 225 x 20mm

Packing: 1 piece



**Code: FB74SSG5** M2.015.898F/

**Model: SM52/SM74/SM102/XL105**

Description: Grey/5mm raised

Size: 225 x 20mm

Packing: 1 piece



**Code: FB74SSFY** M2.015.878/

**Model: SM52/SM74/CD102/XL105/  
XL145/XL162**

Description: Yellow/Flat

Size: 225 x 20mm

Packing: 1 piece



**Code: FB74SSY** M2.015.840F/

**Model: SM52/SM74/XL75/SM102/ CD102/  
XL105**

Description: Yellow/9mm raised

Size: 227 x 20mm

Packing: 1 piece



**Code: FB74SSY5** M2.015.896F/01

**Model: SM52/SM74/SM102/CD102/  
XL105**

Description: Yellow/5mm raised

Size: 227 x 20mm

Packing: 1 piece



**Code: FB74SSGRS** M2.015.872/01

**Model: SM52/SM74/SM102/CD102/  
XL105**

Description: Grey/1.5mm raised

Size: 225 x 20mm

Packing: 1 piece



**Code: FB74SSCDFG** F4.614.831F/

**Model: SM102/CD102/XL75/XL105/  
XL145/XL162**

Description: Grey/Flat

Size: 247 x 20mm

Packing: 1 piece



**Code: FB74SSCDG** F4.614.821F/

**Model: SM102/CD102/XL75/XL105**

Description: Grey/9mm raised

Size: 247 x 20mm

Packing: 1 piece



**Code: FBSSFXL** M2.015.880/

**Model: SM102/CD102/XL75/XL105/  
XL145/XL162**

Description: Green/Flat

Size: 235 x 20mm

Packing: 1 piece



**Code: FBSSXLB-F** F4.614.871/

**Model: SM102/XL75/XL105/XL145/XL162**

Description: Blue/7mm raised

Size: 245 x 10mm

Packing: 1 piece



**Code: FBSSXLG** F4.614.861/

**Model: SM102/XL75/XL105/XL145/ XL162**

Description: Grey/7mm raised

Size: 245 x 10mm

Packing: 1 piece



**Code: FBSSXLB** F4.614.560/01

**Model: SM102/XL75/XL105/XL145/XL162**

Description: Blue/7mm grooved

Size: 245 x 10mm

Packing: 1 piece



**Code: FBSSXLW** F4.614.881F/

**Model: SM102/XL75/XL105/XL145/XL162**

Description: White/7mm grooved

Size: 245 x 10mm

Packing: 1 piece



**Code: FBSSXLR** F4.614.570/

**Model: SM102/XL75/XL105/XL145/XL162**

Description: Red/7mm grooved

Size: 245 x 10mm

Packing: 1 piece



**Code: FBSSXLP** F4.614.891F/

**Model: SM102/XL75/XL105/XL145/XL162**

Description: Pink/7mm grooved

Size: 245 x 10mm

Packing: 1 piece



**Code: FBSSXLT** F4.614.885F/

**Model: SM102/XL75/XL105/XL145/XL162**

Description: Yellow (Tan)/7mm grooved

Size: 245 x 10mm

Packing: 1 piece



**LubeClean**  
LUBRICATES AND CLEANS!



REFER TO  
PAGE 128

**Code: LUBECLEAN**

Packing: 900 gram (2.0 lbs)/can - 12 cans/box

## SLOW DOWN BELTS - HEIDELBERG

**Code: FB102SS** C3.015.453/

**Model: SM74/SM102/CD102**

CD102 s/n 543064+ SM74 s/n 621124+

Description: Green/Perforated

Size: 215 x 38mm

Packing: 1 piece



**Code: FB102SSC** C3.015.653/

**Model: SM102/CD102**

Description: Green/12mm raised compressible

Size: 215 x 38mm

Packing: 1 piece



**Code: FB74SSP** M2.015.357/01

**Model: SM74**

Description: Pink/10mm raised

Size: 220 x 38mm

Packing: 1 piece



## SLOW DOWN BELTS - KOMORI

**Code: FBKD** GFH-8310-956

**Model: KOMORI**

Description: Black

8mm raised/26 holes

Size: 210 x 14mm

Packing: 1 piece



**Code: FBKS** GFH-8310-902

**Model: KOMORI**

Description: Black

7mm raised/26 holes

Size: 210 x 14mm

Packing: 1 piece



**Code: FBKX** ZPO-8300-101

**Model: KOMORI**

Description: Black

5mm raised/35 holes

Size: 210 x 14mm

Packing: 1 piece



**Code: FBKN** GFH-8310-9S0

**Model: KOMORI**

Description: Black

5mm raised/52 holes

Size: 210 x 14mm

Packing: 1 piece



## WEKO

**Code: FBWEK0460** 00.780.0476

**Model: Weko T6/T66 spray unit**

Description: Yellow/Flat

Size: 460 x 12 x 1mm

Packing: 1 piece



**Code: FBWEK0490** 00.780.0475

**Model: Weko T6/T66 spray unit**

Description: Yellow/Flat

Size: 490 x 12 x 1mm

Packing: 1 piece



## SLOW DOWN BELTS - MITSUBISHI

### Code: FBSSMIT1

**Model: Mitsubishi**

Description: Black/6mm raised/30 holes

Size: 214 x 14mm

Packing: 1 piece



### Code: FBSSMIT2

**Model: Mitsubishi**

Description: Black/5mm raised/41 holes

Size: 214 x 14mm

Packing: 1 piece



### Code: FBSSMIT3

**Model: Mitsubishi**

Description: Black/8mm raised/23 holes

Size: 214 x 14mm

Packing: 1 piece



## KBA

### Code: FBSSKBA5 P7721771

**Model: KBA**

Description: Black/Flat 32 holes

Size: 235 x 10mm

Packing: 1 piece



### Code: FBSSKBA6 P7074890

**Model: KBA**

Description: Black/Flat 32 holes

Size: 235 x 15mm

Packing: 1 piece



### Code: FBSSKBA7

**Model: KBA**

Description: Grey/Flat 41 holes

Size: 286 x 20mm

Packing: 1 piece



# Sheet Separators Feeder Brushes

SHEET SEPARATORS

36

SHEET SEPARATORS

## KOMORI

### Code: SHEETB30

Model: Komori SX40

Description: Bent sheet separator

Thickness: 0.15mm / 0.006"

Packing: 12 pcs/bag

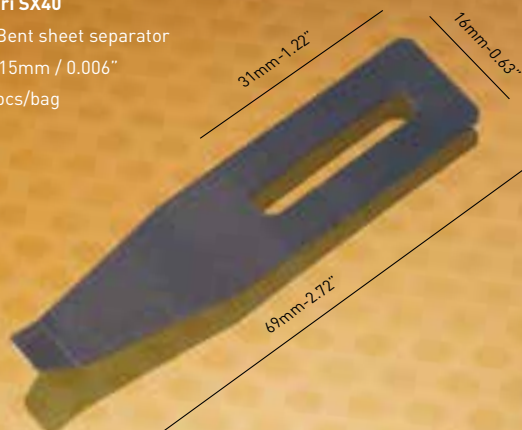

### Code: SHEETB35 444.1689.024

Model: Komori LS

Description: Bent sheet separator

Thickness: 0.08mm / 0.003"

Packing: 12 pcs/bag

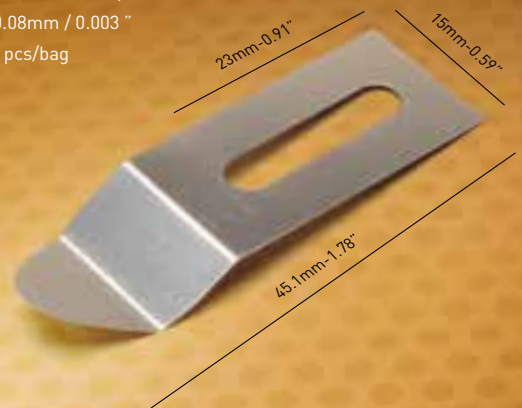

## UNIVERSAL

Code	Thickness (mm/inch)
<b>SHEET101</b>	<b>0.10mm / 0.004"</b>
<b>SHEET102</b>	<b>0.20mm / 0.008"</b>
<b>SHEET103</b>	<b>0.30mm / 0.012"</b>

**Model:** Heidelberg/Roland/Mitsubishi/KBA/Miller

Description: Flat sheet separator  
Packing: 25 pcs/bag

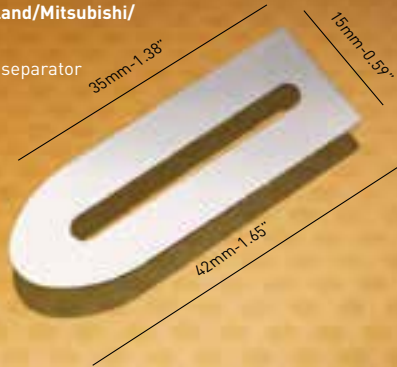

## HAMADA - MULTILITH

**Code: SHEET8015**

**Model:** Hamada/Multilith 1250  
Description: Bent sheet separator  
Thickness: 0.15mm / 0.006"  
Packing: 12 pcs/bag

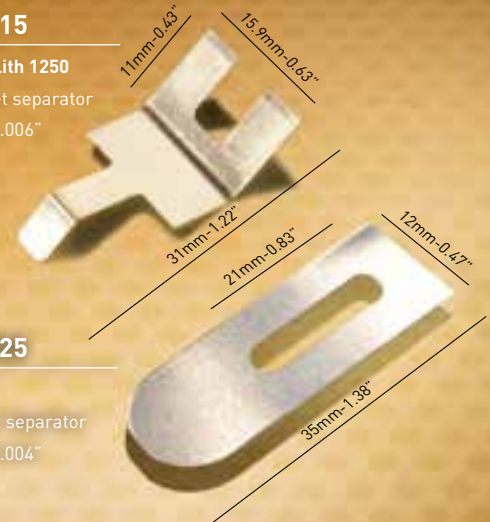

**Code: SHEET8025**

**Model:** Hamada  
Description: Flat sheet separator  
Thickness: 0.10mm / 0.004"  
Packing: 25 pcs/bag

Code	Thickness (mm/inch)
<b>SHEET201</b>	<b>0.10mm / 0.004"</b>
<b>SHEET202</b>	<b>0.20mm / 0.008"</b>
<b>SHEET203</b>	<b>0.30mm / 0.012"</b>

**Model:** Komori/Fuji-Shinohara/Hashimoto

Description: Flat sheet separator  
Packing: 25 pcs/bag

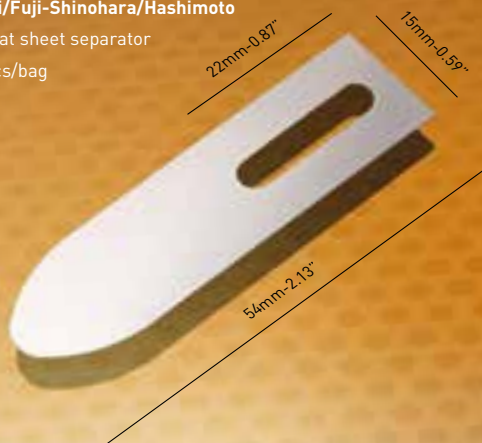

Code	Thickness (mm/inch)
<b>SHEET301</b>	<b>0.10mm / 0.004"</b>
<b>SHEET302</b>	<b>0.20mm / 0.008"</b>
<b>SHEET303</b>	<b>0.30mm / 0.012"</b>

**Model:** Komori/Fuji-Shinohara/Hashimoto

Description: Flat sheet separator  
Packing: 25 pcs/bag

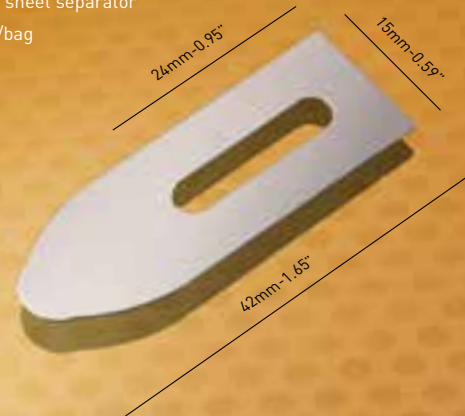

## KOMORI

Code  
**SHEETK01L**  
CA26477A00  
Thickness (mm/inch)  
**0.30mm / 0.012"**

**Model:** KOMORI GL40

Description:  
Bent sheet separator  
- Left  
Packing: 1 piece



Code  
**SHEETK01R**  
CA26478A00  
Thickness (mm/inch)  
**0.30mm / 0.012"**

**Model:** KOMORI GL40

Description:  
Bent sheet separator - Right  
Packing: 1 piece

## SAKURAI

Code	Thickness (mm/inch)
<b>SHEET601</b>	<b>0.10mm / 0.004"</b>
<b>SHEET602</b>	<b>0.20mm / 0.008"</b>
<b>SHEET603</b>	<b>0.30mm / 0.012"</b>

**Model:** Sakurai

Description: Flat sheet separator  
Packing: 25 pcs/bag

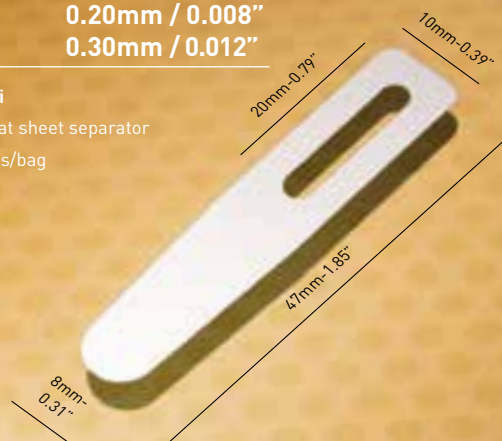

# HEIDELBERG

## Code: SHEETF1

Model: Speedmaster/S-Offset

Description: Fork with flat frame

Thickness: 0.2mm / 0.008"

Packing: 1 piece

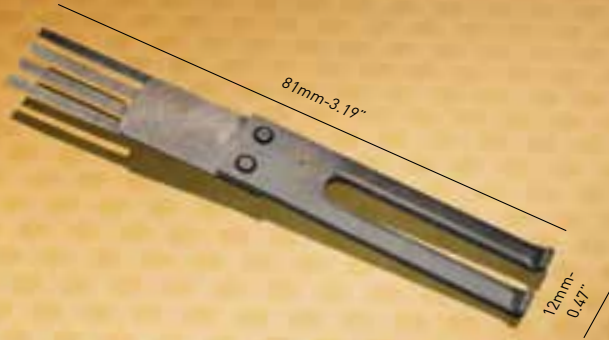

## Code: SHEETF2

Model: Speedmaster/S-Offset

Description: Blade with flat frame

Thickness: 0.2mm / 0.008"

Packing: 1 piece

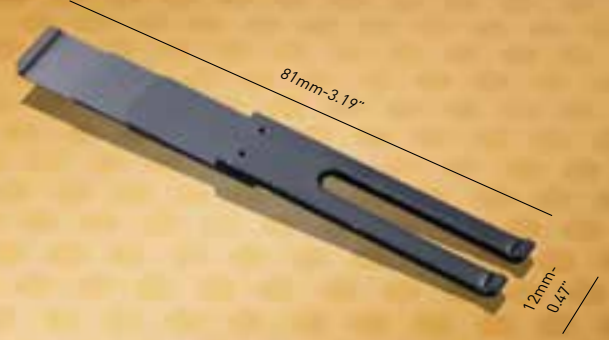

## Code: SHEETB1 66.028.810F/01

Model: Speedmaster/S-Offset

Description: Fork with bent frame

Thickness: 0.2mm / 0.008"

Packing: 1 piece

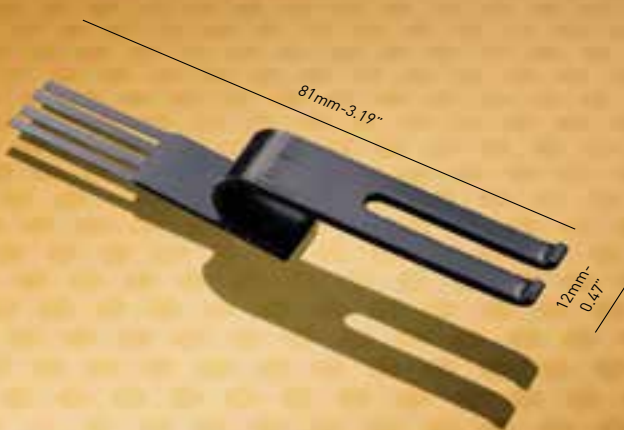

## Code: SHEETB2 66.028.110F/01

Model: Speedmaster/S-Offset

Description: Blade with bent frame

Thickness: 0.2mm / 0.008"

Packing: 1 piece

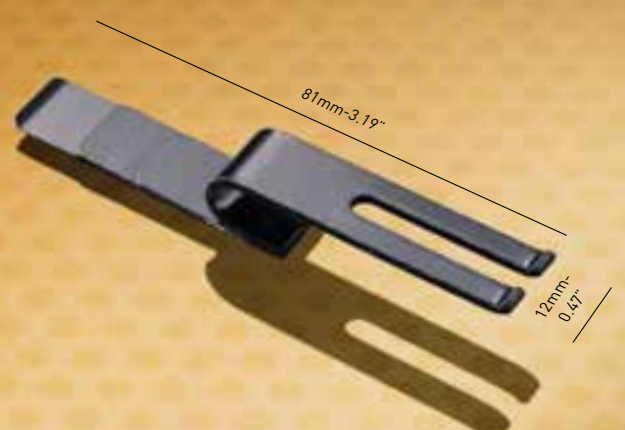

## Code: SHEET105SM 62.028.130S/01

Model: SM52/SM102/CD102/XL105/XL106/  
XL145/XL162

Description: Blade with bent frame

Thickness: 0.2mm / 0.008"

Packing: 1 piece



## Code: SHEET105F

Model: SM52/SM102/CD102/XL105/XL106/  
XL145/XL162

Description: Fork with bent frame

Thickness: 0.2mm / 0.008"

Packing: 1 piece



Code

**SHEET74FS/Pair**  
**SHEET74F1/1pc**  
**SHEET74F2/1 pc**

Model: SM74/PM74/CD74/XL75  
Description: Sheet Separator  
Thickness: 0.20mm/0.008"  
Packing: 1 pair or 1 piece

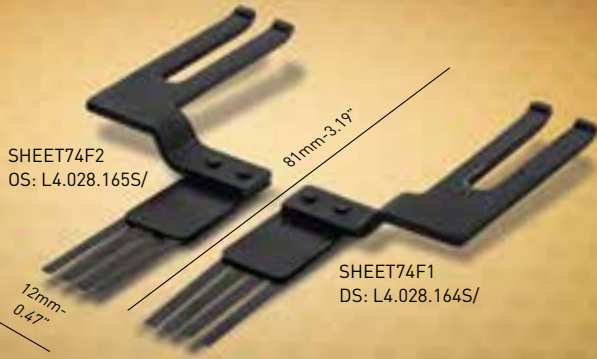

Code

**SHEET74BS/Pair**  
**SHEET74B1/1pc**  
**SHEET74B2/1 pc**

Model: SM74/PM74/CD74/XL75  
Description: Sheet Separator  
Thickness: 0.20mm/0.008"  
Packing: 1 pair or 1 piece

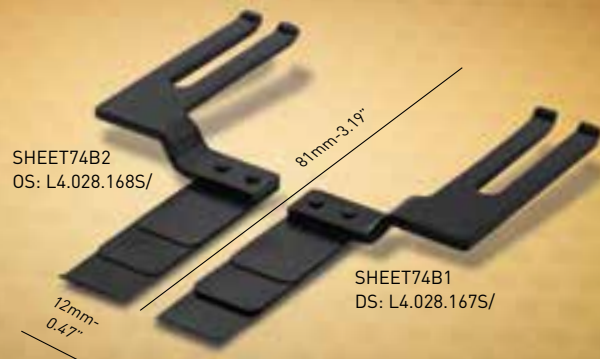

**Code: SHEETCOMBIF** M3.028.824S

**Model: Speedmaster**

Description: Combi sheet separator - Fork  
Thickness: 0.2mm / 0.008"  
Packing: 1 piece

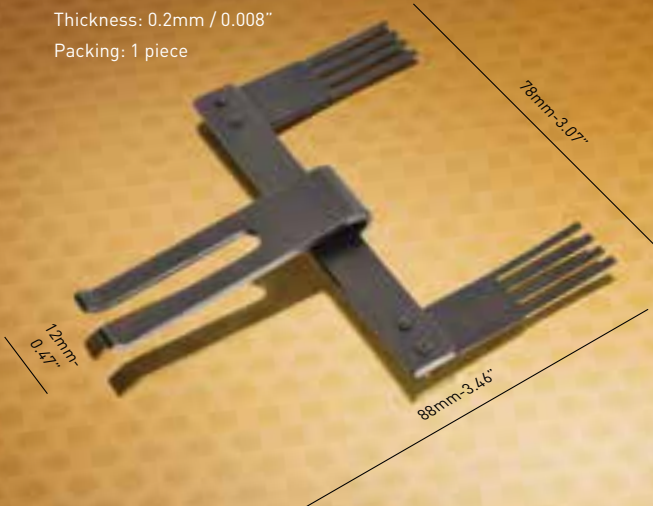

**Code: SHEETCOMBIB**

**Model: Speedmaster**

Description: Combi sheet separator - Blade  
Thickness: 0.2mm / 0.008"  
Packing: 1 piece

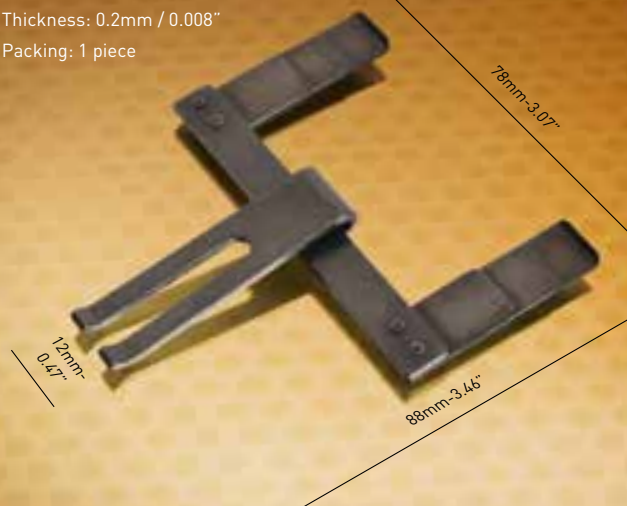

**Code: SHEETCB7475** M3.028.825S/01

**Model: CD74/XL75**

Description: Combi Sheet Separator - Blade  
Packing: 1 piece

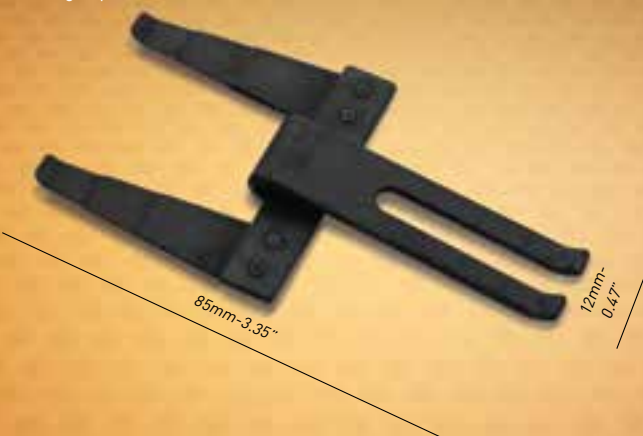

**Code: SHEET52R** 36.017.084

**Model: GT052**

Description: Standard with rubber hood  
Thickness: 1.0mm / 0.039"  
Packing: 1 piece





# HEIDELBERG

**Code: SHEET52**

**Model: GT052**

Description: Standard sheet separator

Thickness: 1.0mm / 0.039"

Packing: 1 piece

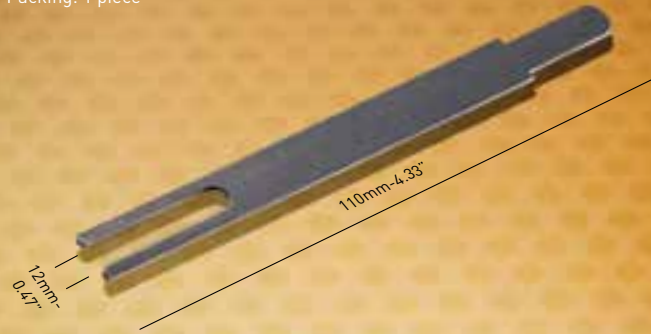

**Code: SHEET46** 42.017.083

**Model: GT046**

Description: Standard sheet separator

Thickness: 1.0mm / 0.039"

Packing: 1 piece



**Code: SHEET46R** 42.017.083F

**Model: GT046**

Description: Standard with rubber hood

Thickness: 1.0mm / 0.039"

Packing: 1 piece



**Code: SHEET5245**

**Model: GT052/M0**

Description: Sheet separator with 45°

Thickness: 0.3mm / 0.012"

Packing: 1 piece



**Code: RHOODGT0** 36.017.084

**Model: GT046/GT052**

Description: Rubber hood for sheet separator

Packing: 12 pcs/bag

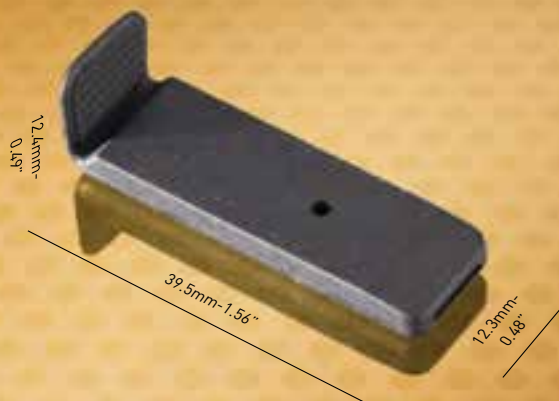

**Code: SHEET6445** 43.017.079

**Model: KORD64/GT046**

Description: Sheet separator with 45°

Thickness: 0.3mm / 0.012"

Packing: 1 piece



## Code: SHEETKBA120

Model: KBA RAPIDA 104/105/142/162

Description: Steel sheet separator

Thickness: 0.2mm / 0.008"

Packing: 1 piece

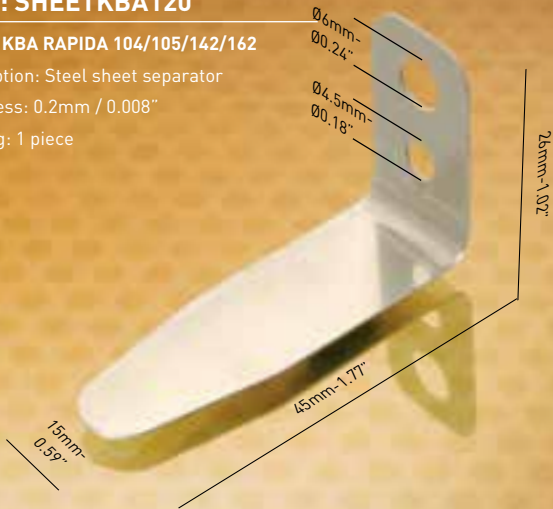

## Code: SHEETKBA140

Model: KBA RAPIDA 104/105/142/162

Description: Steel sheet separator

Thickness: 0.4mm / 0.016"

Packing: 1 piece

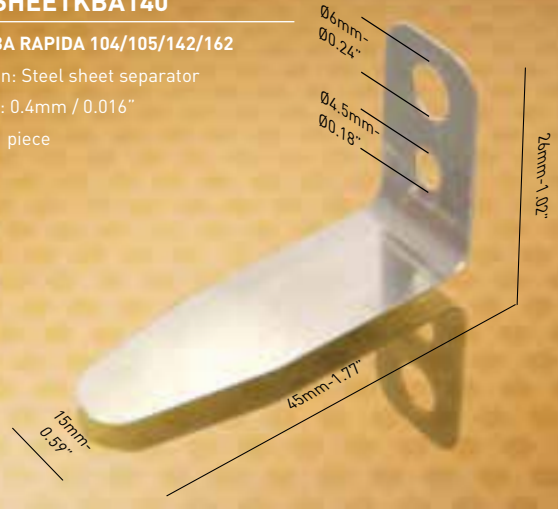

## SHEETKBAPIN

Model: KBA RAPIDA 104/105/142/162

Description: Pin for mounting

SHEETKBA104 SHEETKBAC3

SHEETKBA120 SHEETKBAUNIC110

SHEETKBAC1 SHEETKBAUNIC120

SHEETKABC2 SHEETKBAUNIC130

Packing: 1 piece

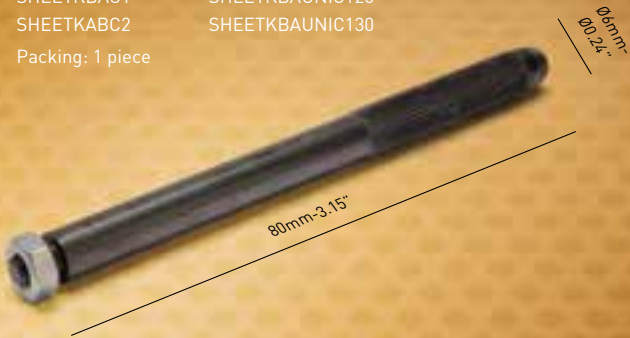

## Code: SHEETKBAC1

Model: KBA RAPIDA 104/105/142/162

Description: Complete assembly

Thickness: 0.1mm / 0.004"

Packing: 1 piece



## Code: SHEETKBAC2

Model: KBA RAPIDA 104/105/142/162

Description: Complete assembly

Thickness: 0.1mm / 0.004"

Packing: 1 piece

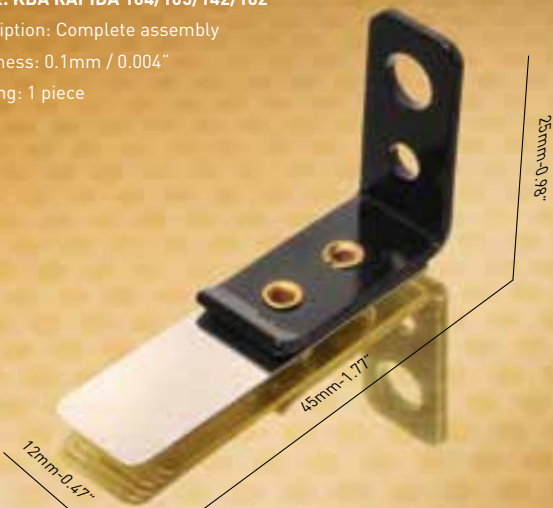

## Code: SHEETKBAC3

Model: KBA RAPIDA 104/105/142/162

Description: Complete assembly

Thickness: 0.1mm / 0.004"

Packing: 1 piece

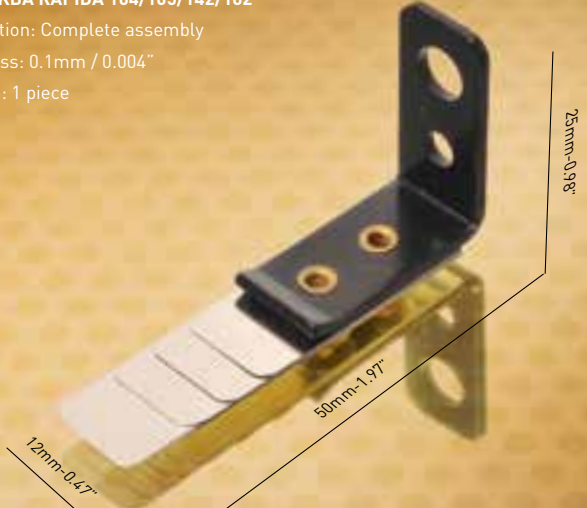

## mitsubishi

Code	Thickness (mm/inch)
<b>SHEET401</b>	<b>0.10mm / 0.004"</b>
<b>SHEET402</b>	<b>0.20mm / 0.008"</b>
<b>SHEET403</b>	<b>0.30mm / 0.012"</b>

**Model:** Mitsubishi  
**Description:** Flat sheet separator  
**Packing:** 25 pcs/bag

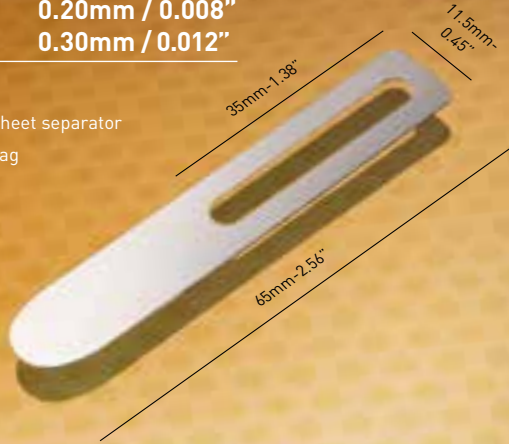

Code	Thickness (mm/inch)
<b>SHEET5015</b>	<b>0.15mm / 0.006"</b>
<b>SHEET5020</b>	<b>0.20mm / 0.008"</b>

**Model:** Mitsubishi  
**Description:** Flat sheet separator  
**Packing:** 25 pcs/bag

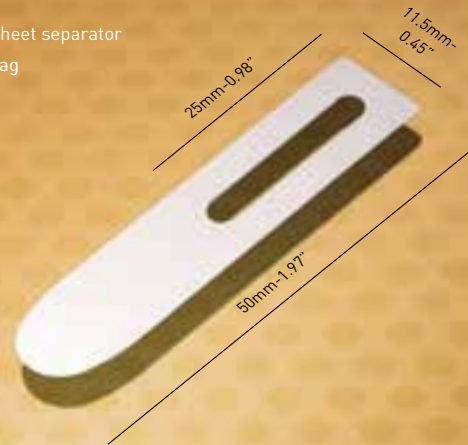

### Code: SHEETB20

**Model:** Mitsubishi  
**Description:** Bent sheet separator  
**Thickness:** 0.15mm / 0.006"  
**Packing:** 12 pcs/bag

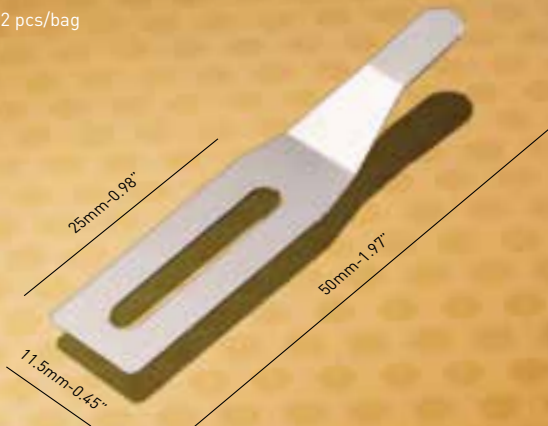

## UNIVERSAL

### Code: SHEETKBAUNI1

**Model:** KBA/MAN/PLANETA/ROLAND  
**Description:** Universal sheet separator complete assembly  
**Thickness:**  
**SHEETKBAUNI110**  
 0.10mm/0.004"  
**SHEETKBAUNI120**  
 0.20mm/0.008"  
**SHEETKBAUNI130**  
 0.30mm/0.012"  
**Packing:** 1 piece

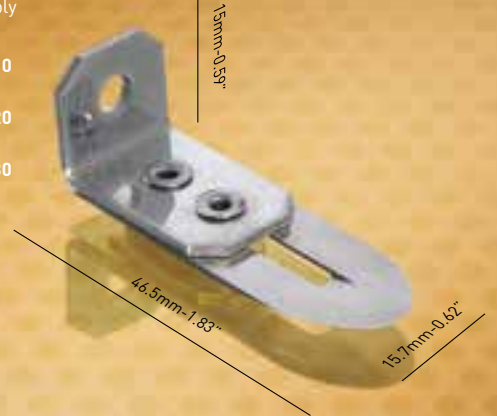

## ROLAND

### Code: SHEET700

**Model:** Roland 200/500/700/800/900  
**Description:** Flat sheet separators  
**Length:**  
**A - 37mm/1.46"**  
**B - 38mm/1.50"**  
**C - 39mm/1.54"**  
**D - 40mm/1.57"**  
**E - 41mm/1.61"**  
**Set composed of**  
 5 sheet separators of  
 different sizes  
**Thickness:** 0.10mm/0.004"  
**Packing:** 1 set/bag

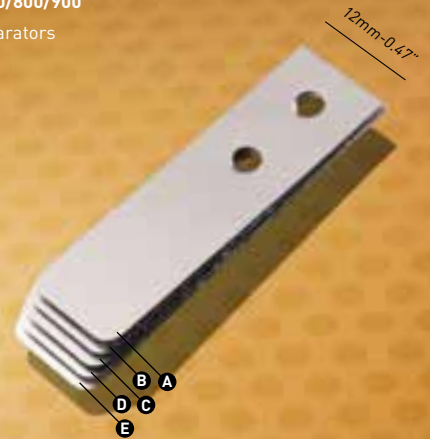

### Code: SHEET900

**Model:** Roland 900  
**Description:** Bent sheet separator  
**Thickness:** 0.30mm / 0.012"  
**Packing:** 12 pcs/bag

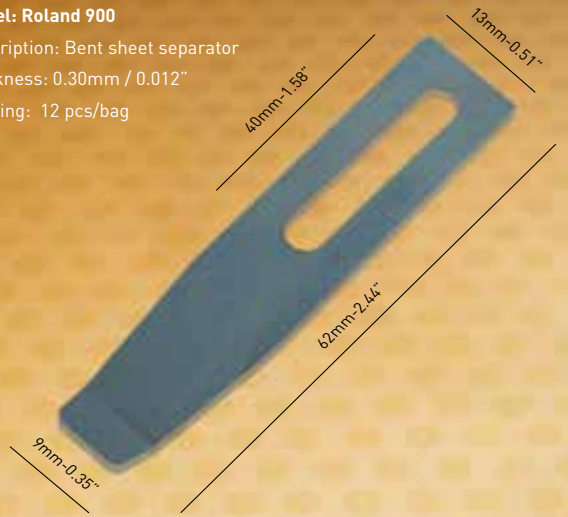

# HEIDELBERG

# FEEDER BRUSHES

**Code: SHEETBR1** 66.028.109F/

**Model: SM72/74/102/S-Offset**

Description: Feeder Brush

Packing: 1 piece



**Code: SHEETBR3** A4.016.218/01

**Model: Quickmaster 46 DI/Printmaster 46**

Description: Feeder Brush

Packing: 1 piece

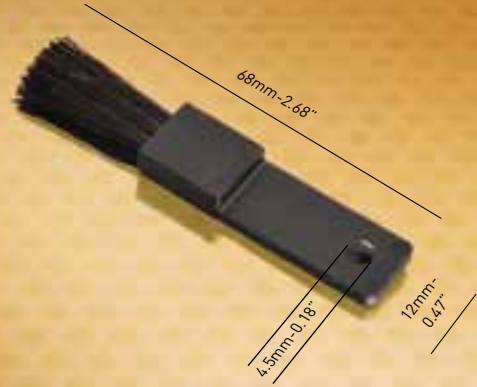

**Code: SHEETBR2** 04.022.069

**Model: GTO/MO/S-Offset/SM52/72/102**

Description: Feeder Brush

Packing: 1 piece

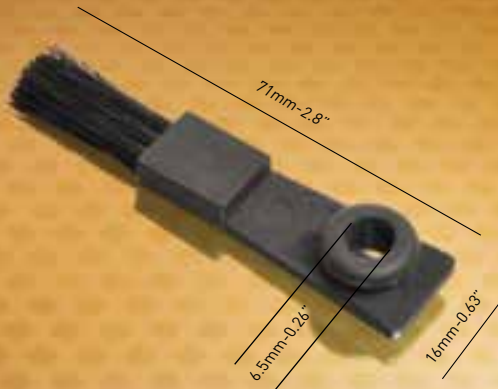

**Code: SHEETBR2C** 04.022.069F/02

**Model: GTO/MO/S-Offset/SM52/72/102**

Description: Feeder brush with clamp

Packing: 1 piece

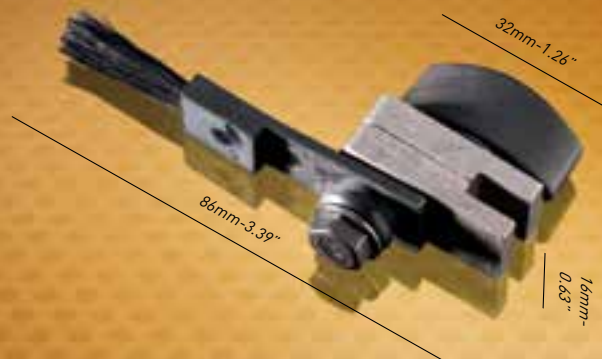

# RYOBI - ITEK

**Code: SHEET9015**

**Model: Ryobi/Itek**

Description: Bent sheet separator

Thickness: 0.15mm / 0.006"

Packing: 12 pcs/bag

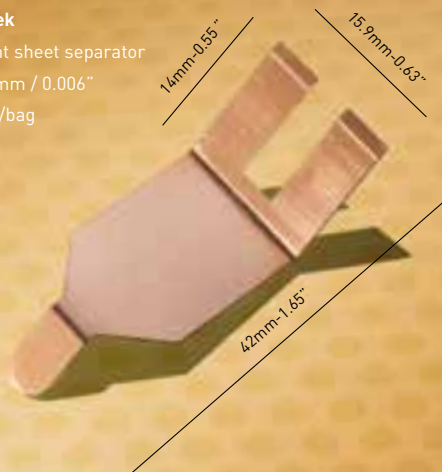

**Code: SHEET7015**

**Model: Ryobi 520/680/750**

Description: Flat sheet separator

Thickness: 0.15mm / 0.006"

Packing: 25 pcs/bag



# KBA

## Code: SHEETBRKBA1

Model: KBA Rapida 105/142/162

Description: Feeder brush

Packing: 1 piece

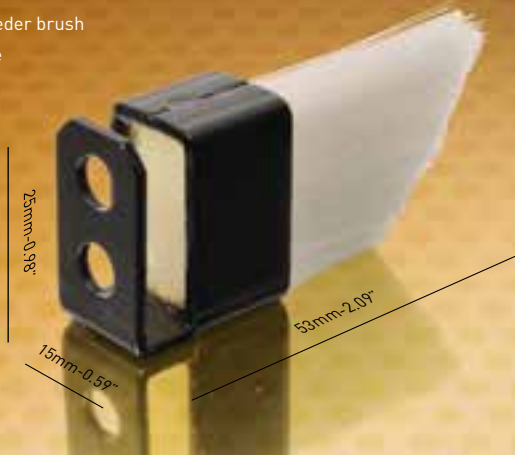

## Code: SHEETBRKBA2

Model: KBA Rapida 105/142/162

Description: Feeder brush

Packing: 1 piece

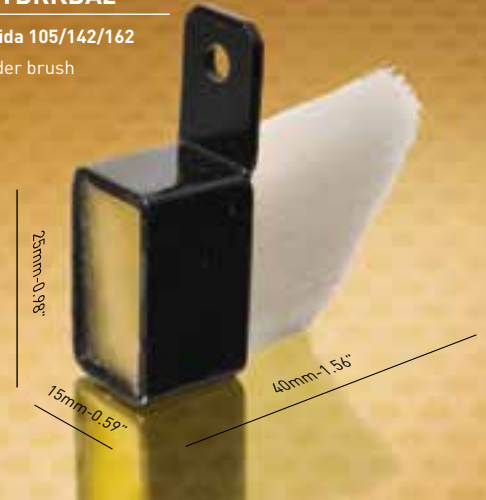

## Code: SHEETBRKBA3

Model: KBA Rapida 105/142/162

Description: Feeder brush

Packing: 1 piece

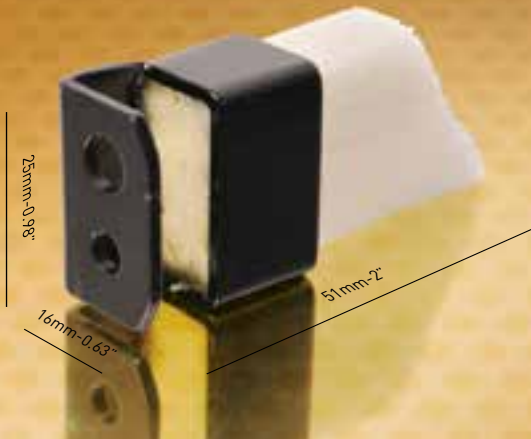

# KOMORI

## Code: SHEETBRK01 444-1665-005

Model: Komori 440/540/640/840

Description: Feeder brush

Packing: 1 piece

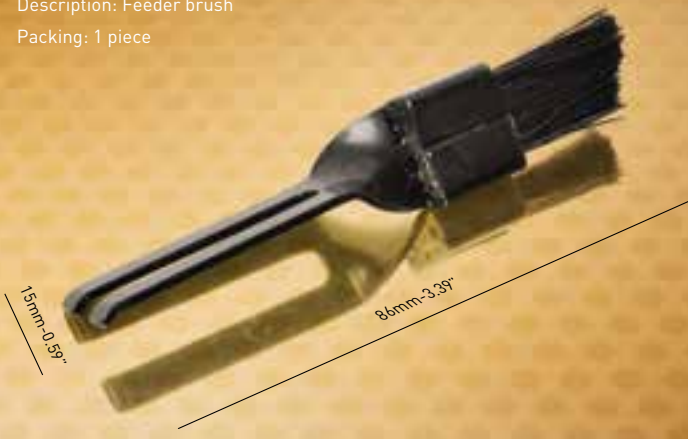

## Code: SHEETBRK02

Model: All Komori models

Description: Feeder brush

Packing: 1 pair

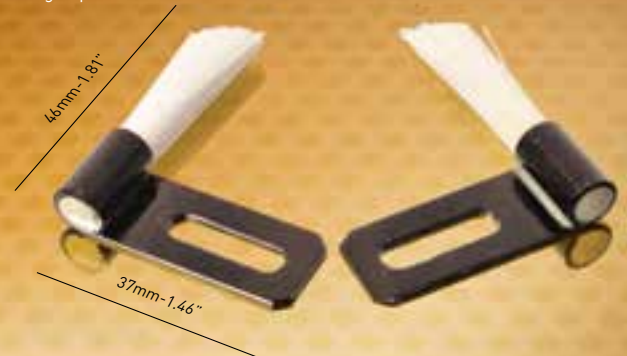

# ROLAND

**Code: SHEETBR21**

Model: M.A.N./Roland/Spies

Description: Feeder brush with holder cpl.

Packing: 1 piece

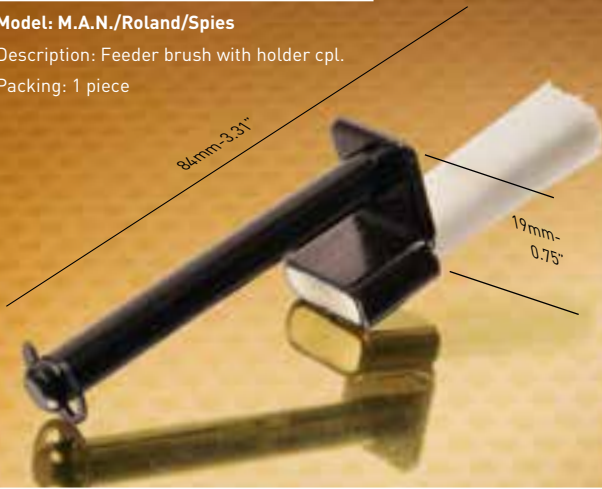

**Code: SHEETBR22**

Model: M.A.N./Roland/Spies

Description: Feeder brush

Packing: 1 piece

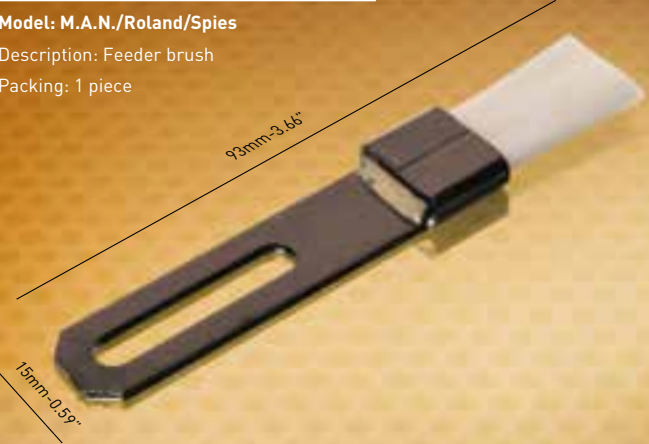

**Code: SHEETBR23**

Model: M.A.N./Roland/Spies

Description: Feeder brush

Packing: 1 piece

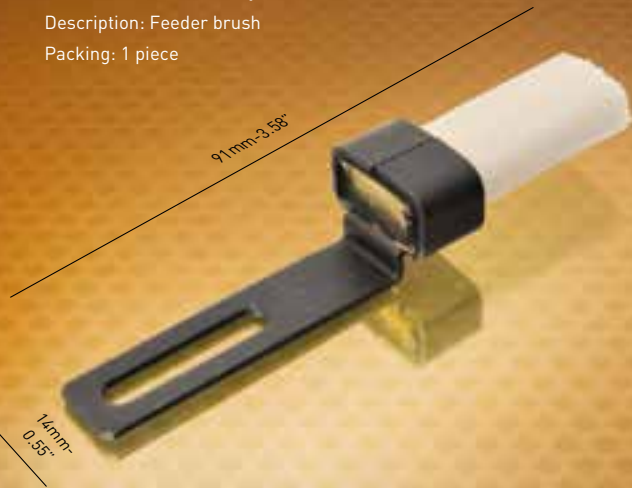

**Code: SHEETBR24**

(old code: SHEET800)

Model: M.A.N./Roland/Spies  
(popular on Roland 800)

Description: Feeder brush

Packing: 1 piece

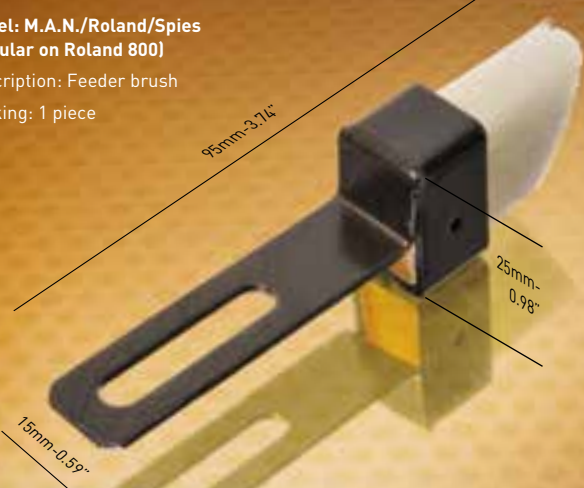

**Code: SHEETBR25**

Model: M.A.N./Roland/Spies

Description: Feeder brush

Packing: 1 piece

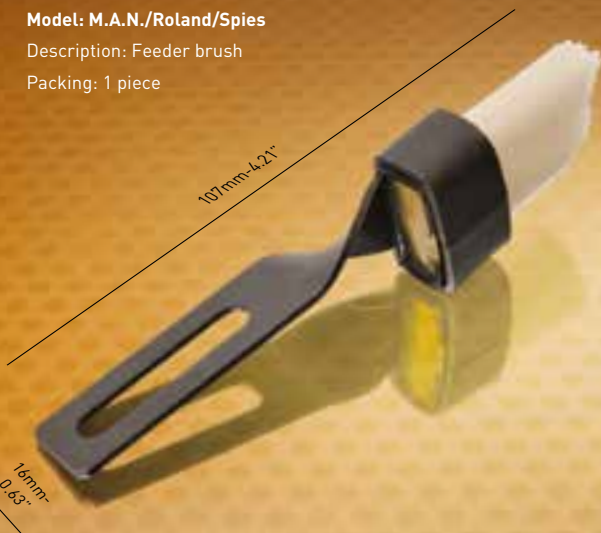

*Parts for Heidelberg Platen T and GT are listed on pages 74 & 75*



# Brush Wheels and Rubber Wheels

BRUSH WHEELS

46

BRUSH WHEELS

## AKIYAMA

**Code:** BWAKIYAMA01

**Model:** AKIYAMA

Description: Brush wheel

Packing: 1 piece

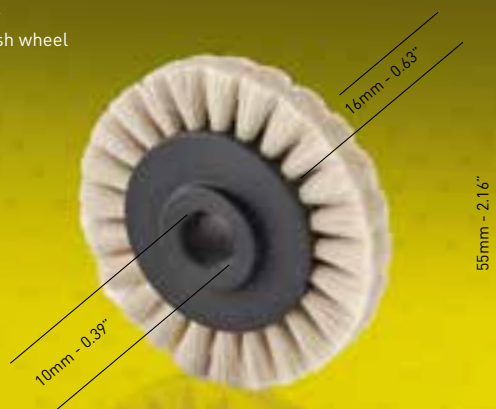

## NIKKO

**Code:** BWNIKK01

**Model:** Nikko Diecutter

Description: Brush wheel

Packing: 1 piece





## HEIDELBERG

### Code: BWHEIWHITE

Model: Heidelberg SORM/SORD/SORS  
SM52/72/74/102  
Miller TP41S/TP104

Description: White brush wheel with soft bristles for paper

Packing: 1 piece

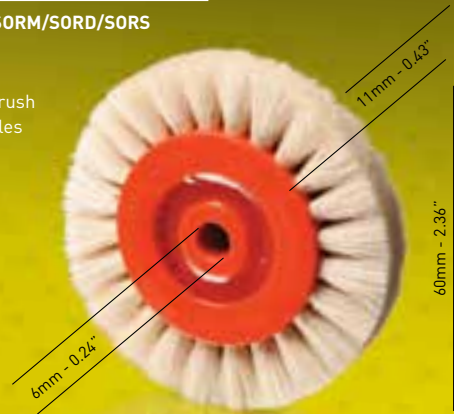

### Code: BWHEIBLACK

Model: Heidelberg SORM/SORD/SORS  
SM52/72/74/102  
Miller TP41S/TP104

Description: Black brush wheel with harder bristles for cardboard

Packing: 1 piece



## BOBST

### Code: BWBOBST1

Model: BOBST

Description: Brush wheel

Packing: 1 piece



### Code: BWBOBST2

Model: BOBST

Description: Brush wheel with aluminum core

Packing: 1 piece





# KBA

## Code: BWKBA1

Model: KBA RAPIDA 104/KBA 105

Description: Brush wheel – hard bristles complete with 2 bearings

Packing: 1 piece



## Code: BWKBA9

Model: KBA RAPIDA 104/KBA 105

Description: Brush wheel – soft bristles complete with 2 bearings

Packing: 1 piece



## Code: BWKBA2

Model: KBA RAPIDA 104/KBA 105

Description: Brush wheel for cardboard complete with 2 bearings

Packing: 1 piece



## Code: BWKBA8

Model: KBA RAPIDA 104/KBA 105

Description: Brush wheel for paper complete with 2 bearings

Packing: 1 piece

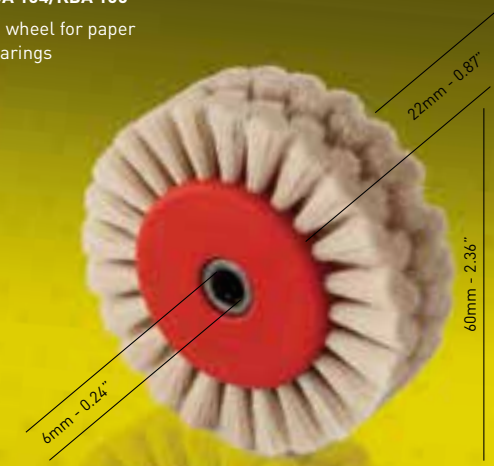

## Code: BWKBA3

Model: KBA/Planeta

Description: Brush wheel for cardboard complete with 2 bearings

Packing: 1 piece



## Code: BWKBA7

Model: KBA/Planeta

Description: Brush wheel for paper complete with 2 bearings

Packing: 1 piece

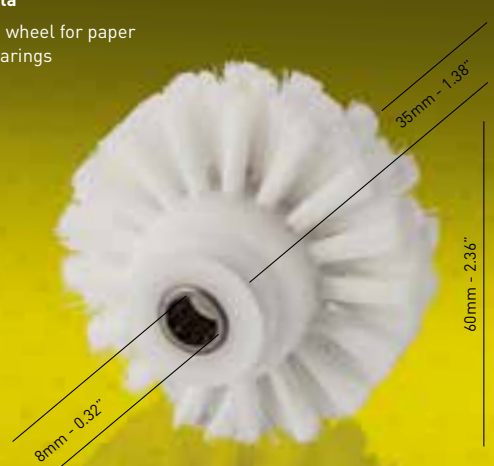

**Code: BWKBA5**

**Model: KBA RAPIDA 142/162 (all models)**

Description: Brush wheel for paper complete with 2 bearings

Packing: 1 piece



**Code: BWKBA6**

**Model: KBA RAPIDA 142/162 (all models)**

Description: Brush wheel for cardboard complete with 2 bearings

Packing: 1 piece

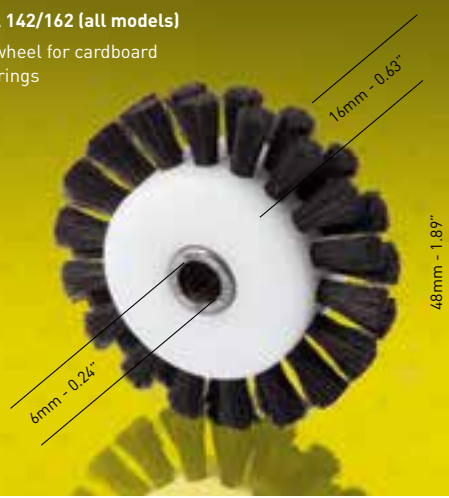

**Code: BWKBA4**

**Model: KBA RAPIDA 105**

Description: Brush wheel complete with bearing

Packing: 1 piece



**SHINOHARA**

**Code: BWSHIN01**

**Model: Shinohara (all models)**

Description: White brush wheel for paper

Packing: 1 piece



**SAKURAI**

**Code: BWSAKU1**

**Model: Sakurai (all models)**

Description: White brush wheel for paper

Packing: 1 piece

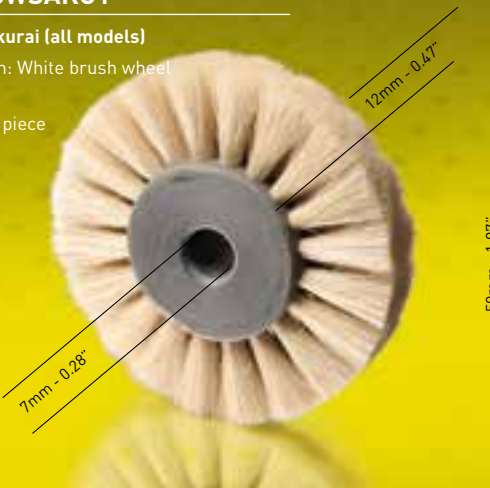

**Code: BWSHIN02**

**Model: Shinohara (all models)**

Description: White brush wheel for paper

Packing: 1 piece

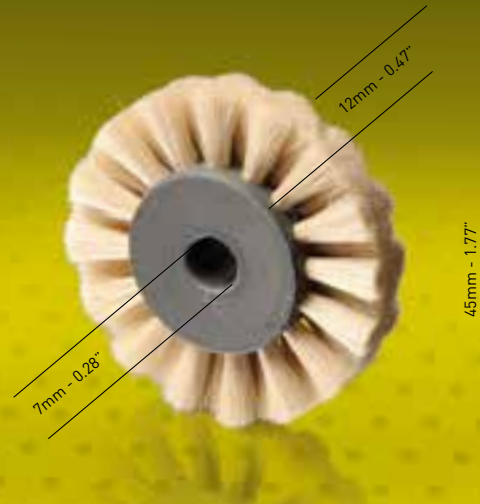

# KOMORI

**Code: BWKR1** 4441341204

**Model: KOMORI (all models)  
ROLAND/MABEG**

Description: White brush wheel for paper

Packing: 1 piece



**Code: BWKR2** 4441341304

**Model: KOMORI (all models)  
ROLAND/MABEG**

Description: Black brush wheel for cardboard

Packing: 1 piece



**Code: BWKR4** 4441341124

**Model: KOMORI (all models)  
ROLAND/MABEG**

Description: Black brush wheel for cardboard

Packing: 1 piece



**Code: BWKR5**

**Model: KOMORI**

Description: Black brush wheel - small

Packing: 1 piece



**Code: BWKRWHITE**

**Model: KOMORI (all models)  
ROLAND 700/600/REKORD (all models)**

Description: White brush wheel for paper

Packing: 1 piece

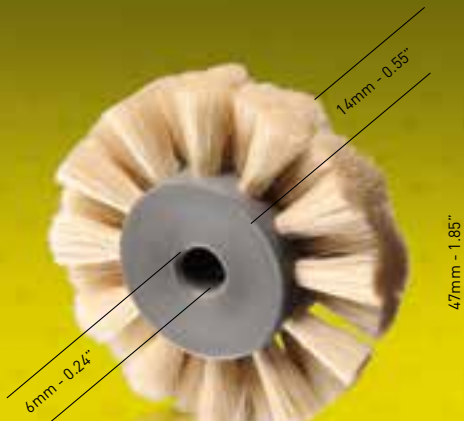

**Code: BWKRBLACK**

**Model: KOMORI (all models)  
ROLAND 700/600/REKORD (all models)**

Description: Black brush wheel for cardboard

Packing: 1 piece



# MITSUBISHI

## Code: BWMITWHITE

Model: Mitsubishi (all models)

Description: White brush wheel for paper

Packing: 1 piece

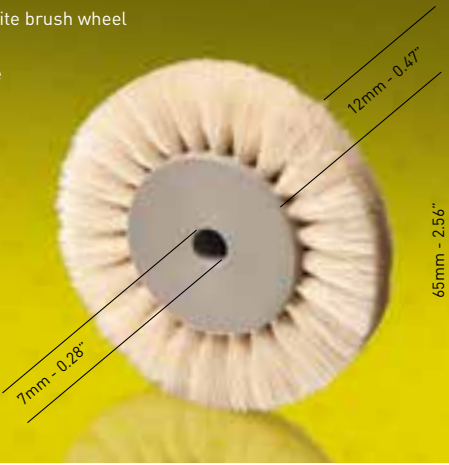

## Code: BWMITBLACK

Model: Mitsubishi (all models)

Description: Black brush wheel for cardboard

Packing: 1 piece

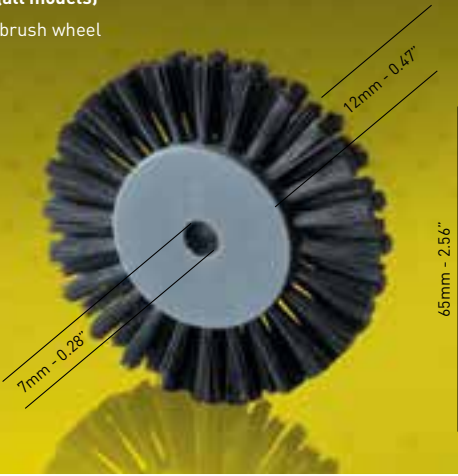

# ROLAND

## Code: BWKR1

Model: ROLAND (all models)  
KOMORI (all models)

Description: White brush wheel for paper

Packing: 1 piece

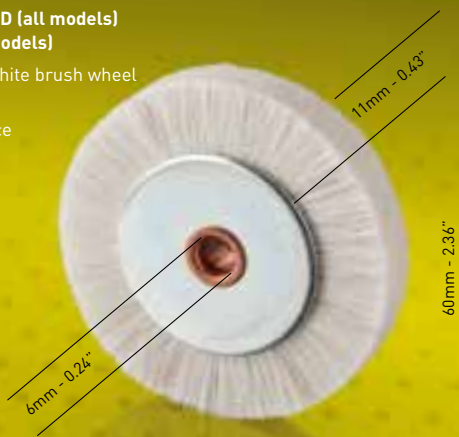

## Code: BWKR2

Model: ROLAND (all models)  
KOMORI (all models)

Description: Black brush wheel for cardboard

Packing: 1 piece



## Code: BWKR3

Model: ROLAND (all models)  
KOMORI/MABEG

Description: White brush wheel for paper

Packing: 1 piece



## Code: BWKR4

Model: ROLAND (all models)  
KOMORI/MABEG

Description: Black brush wheel for cardboard

Packing: 1 piece



# RYOBI

**Code: BWRYOBI01**

**Model: RYOBI**

Description: White brush wheel for paper

Packing: 1 piece



**Code: BWRYOBI02**

**Model: RYOBI**

Description: White brush wheel for paper

Packing: 1 piece

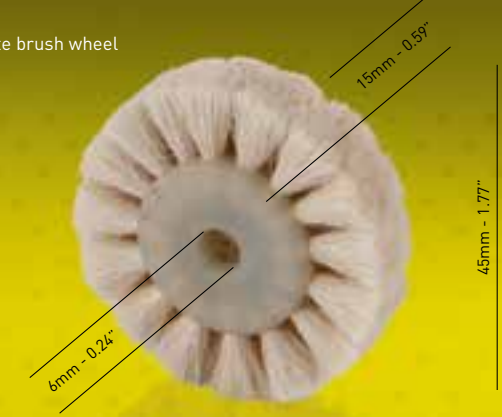

**Code: BWRYOBI03**

**Model: RYOBI**

Description: Black brush wheel for cardboard

Packing: 1 piece



**Code: BWRYOBI04**

**Model: RYOBI**

Description: White brush wheel for paper

Packing: 1 piece



BRUSH WHEELS

52

*Blanket repair, plate deletion gels and plate correction pens can all be found on page 129*



**Code: POSGEL**



**Code: RBR250**

# RUBBER WHEELS - HEIDELBERG

## Code: RWHEIS

Model: Heidelberg SORM/SORD/SORS/  
SM52/72/74/102

Description: Soft rubber wheel for feeder

Packing: 1 piece



## Code: RWHEIH

Model: Heidelberg SORM/SORD/SORS/  
SM52/72/74/102

Description: Hard rubber wheel for feeder

Packing: 1 piece



## Code: RWHEI1 89016236 HARD

Model: Heidelberg SM52

Description: Hard rubber wheel for feeder

Packing: 1 piece



## Code: RWHEI2 89016236 SOFT

Model: Heidelberg SM52

Description: Soft rubber wheel for feeder

Packing: 1 piece



## Code: RWHEI6 F4.614.555F

Model: Heidelberg CD74/XL75/SM102/  
SX102/CX102/  
CD102/XL105/XL106/XL145/XL162

Description: Friction wheel for sheet breaking

Packing: 1 piece



Find the new Universal Seal for  
Tresu D2 chambers



and our new Steel and Brass Brushes  
for cleaning anilox rollers on page 61



# KBA

## Code: RWKBA1

Model: KBA SRO 72/KBA RAPIDA 72/74

Description: Soft rubber wheel with bearing

Packing: 1 piece

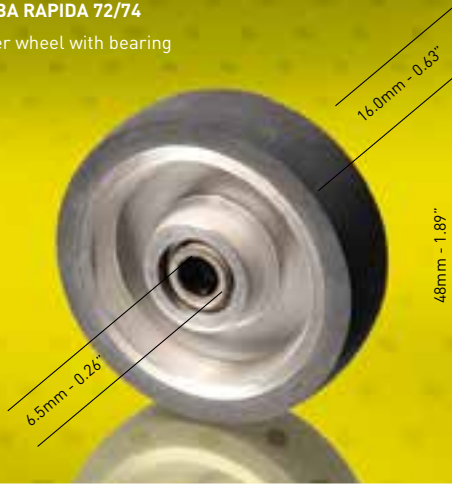

## Code: RWKBA2

Model: KBA RAPIDA 104/142/162 (all models)  
Miller TP41S/TP104

Description: Soft rubber wheel

Packing: 1 piece

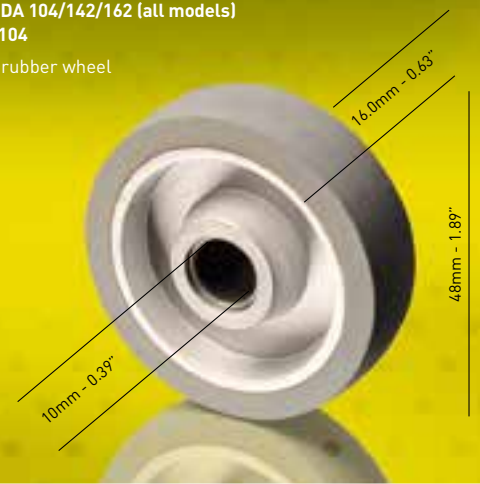

## Code: RWKBA3

Model: KBA RAPIDA 104/KBA 105

Description: Rubber wheel with bearing

Packing: 1 piece



## Code: RWKBA4

Model: RAPIDA 142/KBA 162 (all models)

Description: Rubber wheel with bearing

Packing: 1 piece



## Code: RWKBA5

Model: KBA

Description: Rubber wheel for feeder

Packing: 1 piece

Also ask for:  
Code: RWKBASP1  
Spindle for RWKBA5  
and RWKBA6

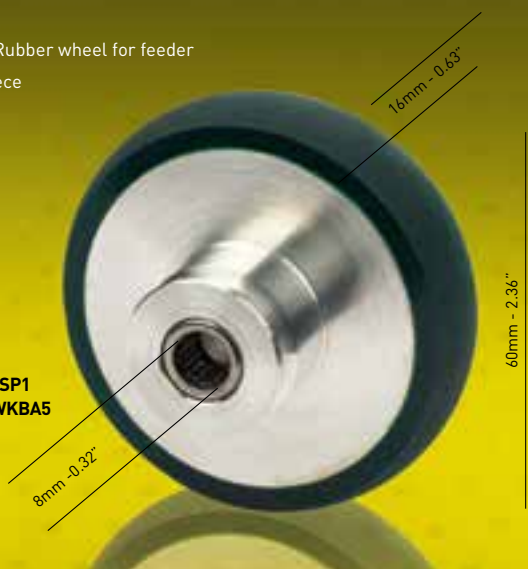

## Code: RWKBA6

Model: KBA

Description: Rubber wheel for feeder

Packing: 1 piece

Also ask for:  
Code: RWKBASP1  
Spindle for RWKBA5  
and RWKBA6



# BOBST

## Code: RWBOBST21

Model: Bobst

Description: Rubber wheel for feeder  
Packing: 1 piece



## Code: RWBOBST22

Model: Bobst

Description: Rubber wheel for feeder  
Packing: 1 piece



## Code: RWK01

Model: Komori

Description: Rubber wheel for feeder  
Packing: 1 piece



## Code: RWK02

Model: Komori

Description: Rubber wheel for feeder  
Packing: 1 piece

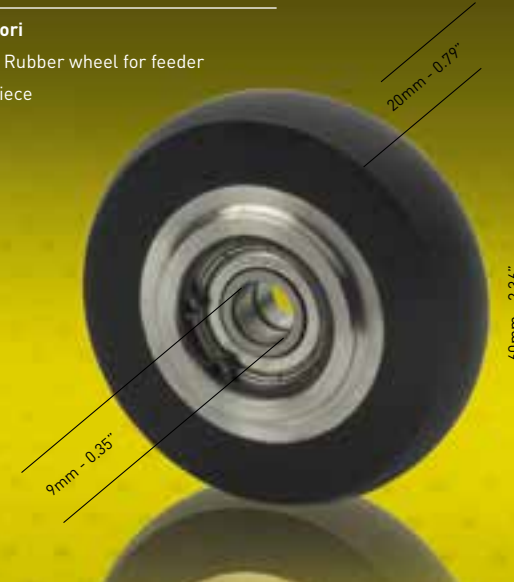

# ROLAND

## Code: RWR1

Model: Roland

Description: Rubber wheel with bearing  
Packing: 1 piece



*Grippers and Gripper Pads on page 78*





# Hickey Removers

HICKEY REMOVERS

56

HICKEY REMOVERS

*Master* hickey removers are designed and manufactured to original specifications. We use the highest quality raw materials including corrosion-proof steel and chemical resistant rubber. The molded rubber tips are chemically bonded to the steel preventing separation.

**Code: HR52**

**Model: Heidelberg SM52**

Description: Hickey remover complete

Packing: 1 piece



# HEIDELBERG

## Code: HR102CPL

Model: Heidelberg SM72/SM102 with Alcolor

Description: Hickey remover complete

Packing: 1 piece



## Code: HR102

Model: SM102 Hickey remover

Description: Replacement rubber

Packing: 5 pcs



## Code: HRSOM0

Model: Heidelberg M0/S-Offset/SM72

Description: Hickey remover complete

Packing: 1 piece



## Code: HR105

Model: Heidelberg XL105

Description: Hickey remover complete

Packing: 1 piece



## Code: HR74

Model: Heidelberg SM74/PM74

Description: Hickey remover complete

Packing: 1 piece

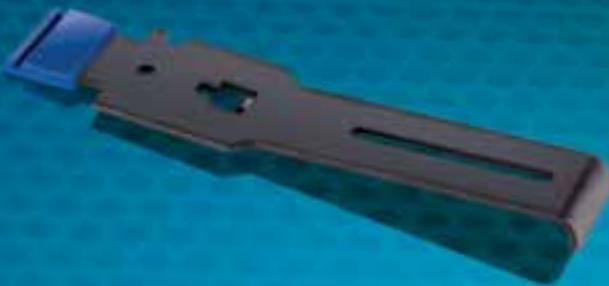

## Code: HRCD74 L2.032.003S

Model: Heidelberg CD74

Description: Hickey remover complete

Packing: 1 piece



# KBA

## Code: HRKBA1

Model: KBA Rapida 142/162

Description: Hickey remover

Size: 46 x 30mm/1.81 x 1.18"

Packing: 1 piece



## Code: HRKBA2

Model: KBA Rapida 142/162

Description: Hickey remover

Size: 50 x 30mm/1.97 x 1.18"

Packing: 1 piece



## Code: HRKBA3 (old code: HRKBA104)

Model: KBA Rapida 104/105

Description: Hickey remover

Width: 40mm/1.57"

Packing: 1 piece



## Code: HRKBA4

Model: KBA Rapida 104/105

Description: Hickey remover

Width: 30mm/1.18"

Packing: 1 piece



## Code: HRKBA5

Model: KBA Rapida 75

Description: Hickey remover

Size: 40mm/1.57"

Packing: 1 piece



## Code: HRFS1

Model: Fuji-Shinohara 52

Description: Hickey remover

Size: 38 x 22mm/1.50 x 0.87"

Packing: 1 piece



# FUJI-SHINOHARA

## MITSUBISHI

### Code: HRMIT1F

**Model: Mitsubishi 1E/1F/Diamond**

Description: Hickey remover

Size: 30 x 46 x 5mm/1.18 x 1.81 x 0.20"

Packing: 1 piece

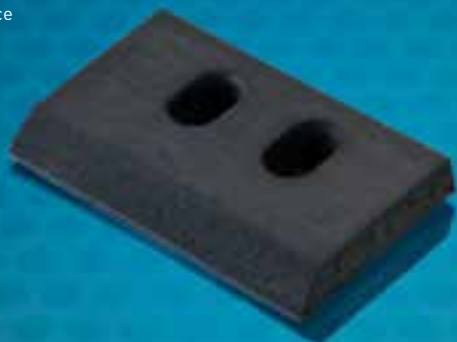

## KOMORI

### Code: HRK01

**Model: Komori Lithrone 40/440/540/640/840**

Description: Hickey remover

Size: 52 x 29mm/2.05 x 1.14"

Packing: 1 piece



### Code: HRMIT3F

**Model: Mitsubishi 3F/Diamond**

Description: Hickey remover

Size: 39 x 45 x 5mm/1.54 x 1.77 x 0.20"

Packing: 1 piece



## ROLAND

### Code: HRR3B

**Model: 600/REKORD 3B/Parva/Favorit/OB/200**

Description: Hickey remover

Size: 22 x 16 x 5mm/0.87 x 0.63 x 0.20"

Packing: 5 pcs

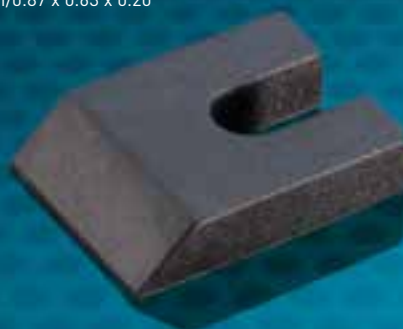

### Code: HRR300

**Model: Roland 300**

Description: Hickey remover

Size: 28 x 28 x 3mm/1.10 x 1.10 x 0.12"

Packing: 5 pcs



### Code: HRR800

**Model: Roland 800**

Description: Hickey remover

Size: 76 x 34 x 3mm/2.99 x 1.34 x 0.12"

Packing: 5 pcs

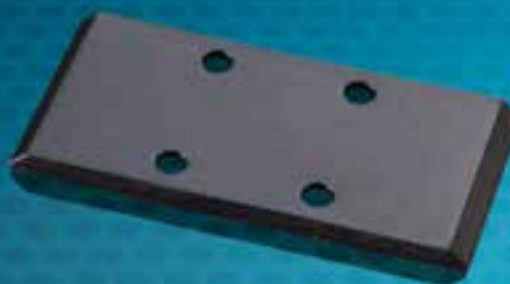

# MASTER PACK

## UNDERLAY PACKING PAPER

**Top quality calibrated non-slip underlay packing paper for accurate adjustment of plate and blanked packing.**

**Pre-treated against solvent and moisture**

- Color coded for easy selection of thickness
- Uniform calibration across the sheet
- Excellent sheet density
- Pre-treated against moisture
- Suitable for all presses
- Available in many pre-cut sizes

0.05mm/0.020"

0.10mm/0.004"

0.125mm/0.005"

0.15mm/0.006"

0.175mm/0.007"

0.20mm/0.008"

0.25mm/0.010"

0.30mm/0.012"

0.40mm/0.016"

0.50mm/0.020"



# MASTER<sup>®</sup> DOCTOR BLADES

## FOR SHEET-FED OFFSET PRESSES

High quality, anti-corrosive stainless steel doctor blades. Excellent for all coating applications.

- Anti-corrosive
- Excellent for water-based inks, coatings and other products with high pH values
- Superior service life compared to standard blades

Code	Width x Thickness	Length of Roll	Coating Unit Type
DSS2520100	25mm x 0.20mm	100M/Roll	Harris & Bruno
DSS2820100	28mm x 0.20mm	100M/Roll	Harris & Bruno
DSS3220100	32mm x 0.20mm	100M/Roll	Harris & Bruno
DSS3520100	35mm x 0.20mm	100M/Roll	TRESU

Also supplied in pre-cut lengths for all press models.

Made from high quality German steel with extreme tensile strength.

The hardness and uniform material structure guarantee a high wear resistance and a long service life.

Manufactured with a thin lamella profile on the front edge of the blade giving outstanding doctoring from the very first sheet.

## ACCESSORIES

### Code: TLBCUT

Description: Doctor blade cutting tool

Packing: 1 piece



### Code: BRUSHSTEEL

Description: Steel Brush for cleaning ceramic anilox rollers

Size: 110 x 60mm - 4 21/64" x 2 23/64"  
Packing: 1 pc/box



### Code: BRUSHBRASS

Description: Brass Brush for cleaning chrome anilox rollers

Size: 110 x 60mm - 4 21/64" x 2 23/64"  
Packing: 1 pc/box



## UNIVERSAL SEAL FOR TRESU D2

### Code: TSEALUNID2 C6.043.252 / 4002628

Model: SM52/SM72/SM74/CD74/XL75  
SM102/CD102/XL105

Description: Universal Coater Seal for Tresu D2 Chamber

Size: 72x24mm

Packing: 50 pcs/pack





# Miscellaneous

# KBA

## Code: TABKBA1

Model: KBA 142/162

Description: Tab for sheet pick-up

Thickness: TABKBA1A 0.30mm/0.012"  
TABKBA1B 0.10mm/0.004"

Packing: 1 set

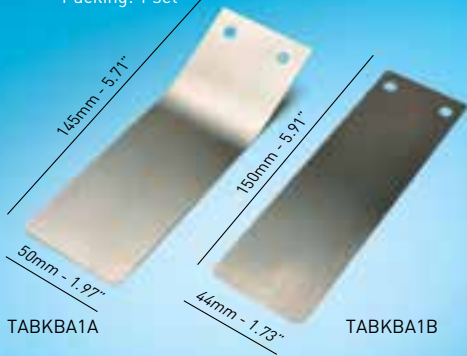

## Code: TABKBA2

Model: KBA 104

Description: Tab for delivery table

Thickness: 0.20mm/0.008"

Packing: 1 piece

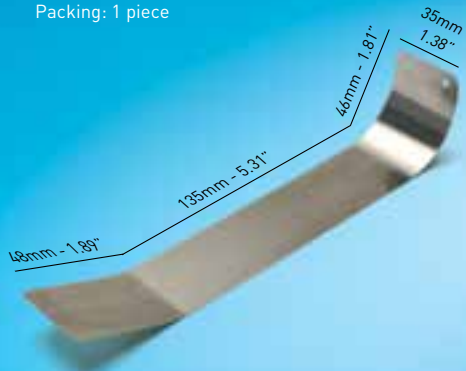

## Code: TABKBA3

Model: KBA Rapida 142/162

Description: Tab for delivery table

Thickness: 0.50mm/0.02"

Packing: 1 piece

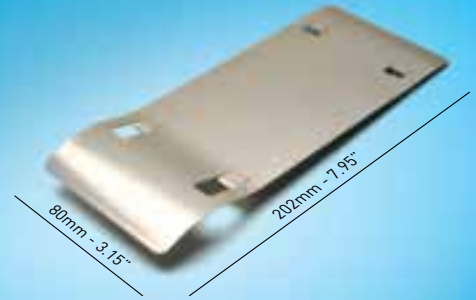

## Code: KBASEAL290 P1660290

Model: KBA 105/106

Description: Sealing segment

Packing: 2 pcs/bag



## Code: IBKBA105

Model: KBA 105

Description: Ink duct end blocks

Packing: 1 pair



## Code: RSKBA20

Model: KBA

Description: KBA (Strecksauger)

Sucker for perfecting cylinders

Packing: 16 pcs/bag



# MITSUBISHI

## INK KEY COVER

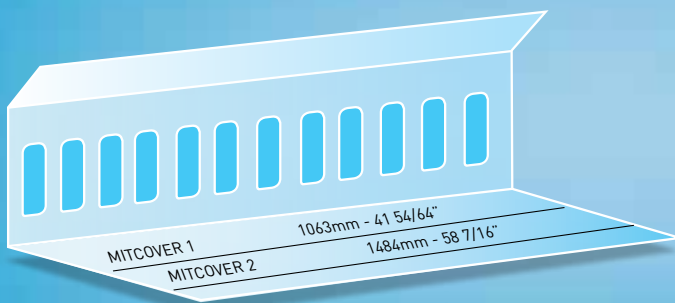

## Code: MITCOVER1 KGV6579G

Model: Mitsubishi Diamond 3000

Description: Ink key cover for ink duct

Length: 1063 mm / 41 54/64"

Packing: 1 piece/10 pcs/box

## Code: MITCOVER2

Model: Mitsubishi

Description: Ink key cover for ink duct

Length: 1484 mm / 58 7/16"

Packing: 1 piece/10 pcs/box

## Code: MITKG08240

Model: Mitsubishi  
1E/1F/1G/3E/3F/3G

Description: Servo motor for ink key

Packing: 1 piece



## Code: GSMIT1

Model: Mitsubishi

Description: Sheet Guide

Packing: 1 piece

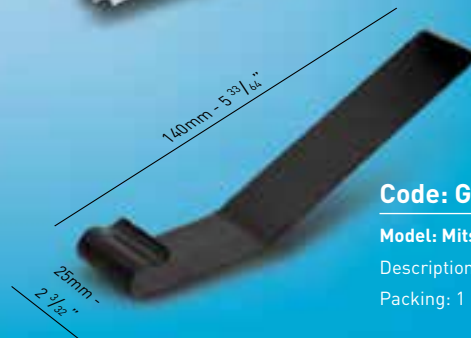



# KOMORI

**Code: GSK1** 364-6800-400

**Model: Komori**

Description: Sheet guide

Width: 38mm/1.49"

Packing: 1 piece



**Code: GSK2** 274-6823-301

**Model: Komori**

Description: Sheet guide

Width: 90mm/3.54"

Packing: 1 piece

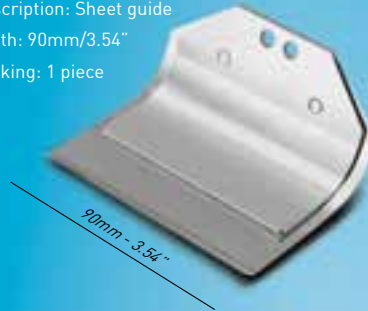

**Code: KPHS**

**Model: Komori**

Description: Plate hanger sucker

Packing: 10 pcs/bag



**Code: GSK3**

**Model: Komori**

Description: Sheet guide

Width: 38mm/1.49"

Packing: 1 piece



**Code: GSK4** 274-6821-301

**Model: Komori**

Description: Sheet guide

Width: 122mm/4.80"

Packing: 1 piece



**Code: FGY3131034**

**Model: Komori**

Description: Braking wheel for Auto Plate loader

Packing: 1 piece - 24pcs/box



**Code: GSK5** FME6810501

**Model: Komori**

Description: Sheet guide

Width: 110mm/4.33"

Packing: 1 piece

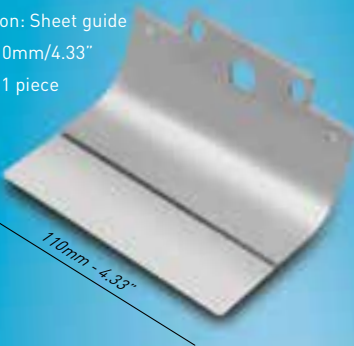

**Code: GSK6** FME6810401

**Model: Komori**

Description: Sheet guide

Width: 195mm/7.68"

Packing: 1 piece

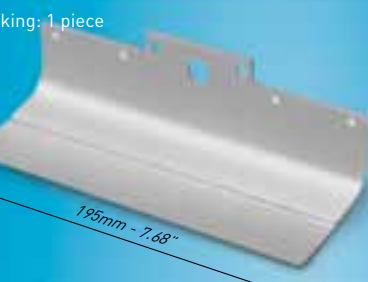

**Code: TLC178181** 261.9700.402

**Model: Komori**

Description: Combination wrench

Size: 17mm x Ø8mm x L181mm

Packing: 1 piece



**Code: GSK7**

**Model: Komori**

Description: Sheet guide

Width: W30mm x L180mm

Packing: 1 piece

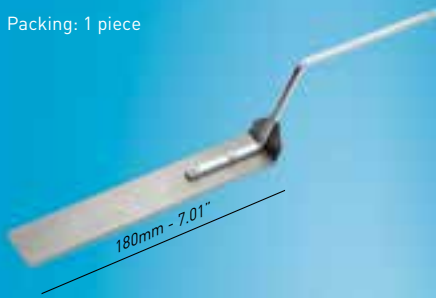

**Code: GSK8**

**Model: Komori**

Description: Sheet guide

Width: W50mm x L200mm

Packing: 1 piece

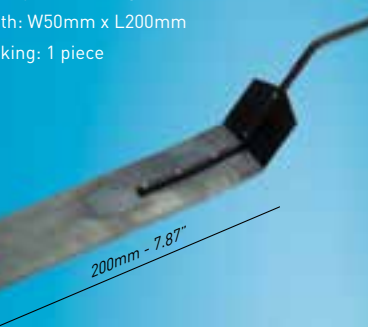

**Code: OILFILTK01** 3Z0-2601-140

**Model: Komori**

Description: Oil filter for Komori

Packing: 1 piece



# GOSS - SHEET GUIDES

## Code: WEBGS1

Model: Goss M600

Description: Small sheet guide

Packing: 3 pcs/bag



## Code: WEBGS2

Model: Goss M600

Description: Large sheet guide

Packing: 3 pcs/bag



## Code: WEBGS11

Model: Goss

Description: Flat sheet guide

Packing: 10 pcs/bag



## Code: WEBGS3

Model: Goss S2000

Description: Small sheet guide

Packing: 3 pcs/bag

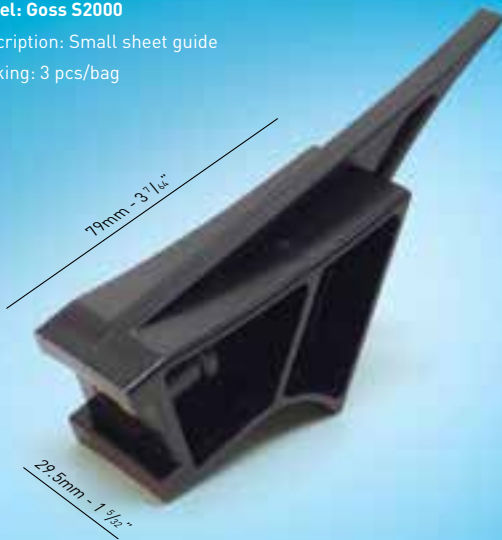

## Code: WEBGS4

Model: Goss S2000

Description: Large sheet guide

Packing: 3 pcs/bag



## Code: WEBGS5

Model: Goss

Description: Small sheet guide

Packing: 3 pcs/bag



## Code: WEBGS6

Model: Goss

Description: Large sheet guide

Packing: 3 pcs/bag



# HEIDELBERG - LIFTING SUCKERS

**Code: LSUCK01** C4.028.009/02

**Model: SM102/M0/SORS/SORD/SORM**

Description: Lifting sucker

Packing: 1 piece



**Code: LSUCK02** 66.028.009/01

**Model: SM102/M0/SORS/SORD/SORM**

Description: Lifting sucker

Packing: 1 piece



**Code: LSUCK03** F2.028.280S/01

**Model: SM102/CD102**

Description: Lifting sucker

Packing: 1 piece



**Code: LSUCK04** F2.028.267S/01

**Model: SM102/CD102**

Description: Lifting sucker

Packing: 1 piece



**Code: LSUCK05** 66.028.809/01

**Model: SM102/CD102**

Description: Lifting sucker

Packing: 1 piece



**Code: LSUCK06** 66.028.409/

**Model: SM102/CD102**

Description: Lifting sucker

Packing: 1 piece



# HEIDELBERG - LIFTING SUCKERS

## Code: LSUCK07

G2.028.0105

### Model: SM52

Description: Lifting sucker  
Packing: 1 piece



## Code: LSUCK08

G2.028.010N

### Model: SM52

Description: Lifting sucker  
with magnet  
Packing: 1 piece



24mm - 15/16"

26mm - 1 1/32"

## Code: LSUCK09 MV.056.999/01

### Model: CD74/XL75

Description: Lifting sucker  
Packing: 1 piece



24mm - 15/16"



35mm - 1 3/8"

77mm - 3 1/32"

## Code: LSUCK10 MV.056.997/01

### Model: CD74/XL75

Description: Lifting sucker- angled  
Packing: 1 piece



24mm - 15/16"



35mm - 1 3/8"

80mm - 3 5/32"

# ROLAND - LIFTING SUCKERS

## Code: LSUCKMA01

### Model: Mabeg

Description: Lifting sucker - paper  
Packing: 1 piece



24mm  
- 61/64"



49mm - 1 15/16"

47mm - 1 27/32"

## Code: LSUCKMA02

### Model: Mabeg

Description: Lifting sucker - cardboard  
Packing: 1 piece



24mm  
- 61/64"



49mm - 1 15/16"

47mm - 1 27/32"

## Code: LSUCKMA03

### Model: Roland 700

Description: Lifting sucker  
Packing: 1 piece



22mm  
- 55/64"



40mm - 1 37/64"

45mm - 1 49/64"

Complete unit with  
metal holder available

# KBA - LIFTING SUCKERS

## Code: LSUCKKBA01

### Model: KBA 75

Description: Lifting sucker  
Packing: 1 piece



23mm  
- 29/32"



51mm - 2 1/64"

## Code: LSUCKKBA02

### Model: KBA 105/106

Description: Lifting sucker  
Packing: 1 piece



23mm  
- 29/32"



71mm - 2 51/64"

# KOMORI

## Code: LSUCKK01

### Model: Komori GL40

Description: Lifting sucker  
Packing: 1 piece



25mm  
- 63/64"



53mm - 2 3/32"

# BLANKET WASH PROFILE RUBBER

**Code: RBWH10**

Model: SM52/SM74/CD74/XL75/  
XL105/XL106

Description: Blanket Wash Profile  
Size: 10M  
Packing: 10M roll/box

**Code: RBWH105106** F2.205.089/03

Model: XL105/XL106  
Description: Blanket Wash Profile  
Size: 1070mm  
Packing: 2 pcs/pack

**Code: RBWH7475** F2.205.029/03

Model: SM74/CD74/XL75  
Description: Blanket Wash Profile  
Size: 770mm  
Packing: 2 pcs/pack

**Code: RBWH52**

Model: SM52  
Description: Blanket Wash Profile  
Size: 560mm  
Packing: 2 pcs/pack



# HEIDELBERG - COATER BLADES

**Code: COATLOS** C4.721.075 O/S

Model: SM102  
Description: Coater blade - large - operator side  
Packing: 1 piece



**Code: COATSDS** C4.721.091 D/S

Model: SM102  
Description: Coater blade - small - drive side  
Packing: 1 piece



**Code: COATLDS** C4.721.074 D/S

Model: SM102  
Description: Coater blade - large - drive side  
Packing: 1 piece

**Code: COATSOS** C4.721.092 O/S

Model: SM102  
Description: Coater blade - small - operator side  
Packing: 1 piece

MISCELLANEOUS PRODUCTS 68 MISCELLANEOUS PRODUCTS



# ADHESIVE UNDERLAY FOIL

## HEIDELBERG - CPC BUTTONS

**Code: CPCBUTSQR** 81.186.3855/02

**Model: CPC button - square - 4 prong**

Description: For CPC console

Packing: 1 piece



**Code: CPCBUTREC** 81.186.3815

**Model: CPC button - rectangular - 4 prong**

Description: For CPC console

Packing: 1 piece



## CPC SERVO MOTOR

**Code: VUER5311 12V** 61.186.5311/03

**Model: PM52/SM52/SM72/SM74/CD74/SM102/CD102** and some M0 with CPC

Description: These servo motors control the ink zones in each printing unit on presses equipped with CPC

Packing: 1 piece/box - 10 boxes/carton



## FESTO VALVE

**Code: M21841111** M2.184.1111

**Model: Heidelberg presses**

Description: Festo solenoid 4/2 way valve

Packing: 1 piece



## SERVO DRIVES

**Code: VUER1141** 61.144.1141/01

Description: Servo-drive for PM-SM74/SM102/All CD/CS/SX/XL

Packing: 1 piece



**Code: VUER1311** 71.112.1311/03

Description: Servo-drive 98/536 [60 C] for PM-SM74/SM102/All CD/CS/SX/XL

Packing: 1 piece



## PERFORATING RULES

HEIDELBERG  
PROTECTIVE  
UNDERLAY  
FOIL

# HEIDELBERG - PLATE SPRINGS

**Code: HSHP1** C4.372.338

**Model: SM102/SM74/SM72/S-Offset**

Description: Plate spring for sheet smoother

Thickness: 0.3mm/0.012"

Packing: 1 piece



**Code: HSHP2**

**Model: SM102/SM74/SM72/S-Offset**

Description: Adhesive separator for small plate spring

Packing: 1 piece



**Code: HSHP4** 42.022.038

**Model: Heidelberg GTO**

Description: Plate spring for GTO sheet smoother

Thickness: 0.3mm/0.012"

Packing: 1 piece



**Code: HSHP3**

**Model: Heidelberg GT046/52**

Description: GTO guide strap holding spring clip

Packing: 1 piece

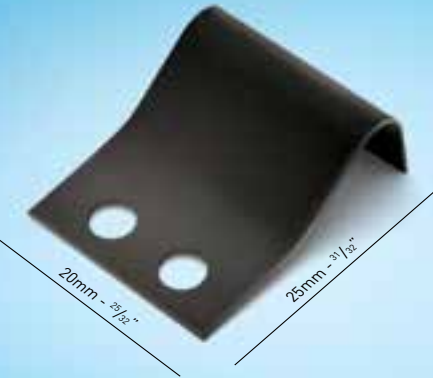

**Code: BARRET** 42.006.033F

**Model: Heidelberg GT046/52/ SM52/MO**

Description: Blanket bar retainer

Packing: 1 piece



**Code: GAUGEDSTEEL**

Description: Gauged steel blade for adjusting ink rollers

Packing: 1 piece

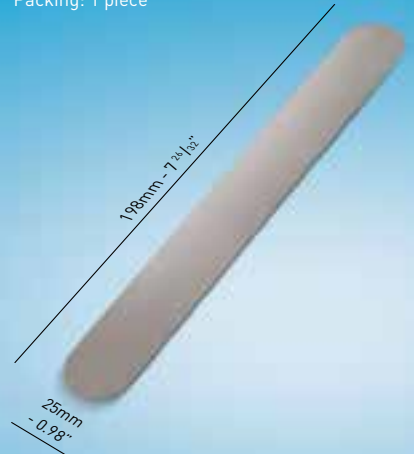

# HEIDELBERG - PNEUMATIC SPRINGS - GAUGED STEEL

**Code: LIFTDEL** 00.580.3118

Description: Pneumatic spring for SM102 delivery

Size: 300 mm/ 11 7/8"

Packing: 1 piece

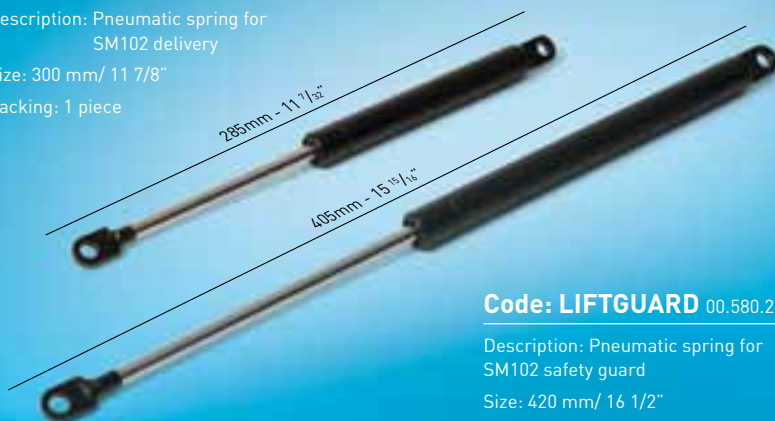

**Code: LIFTGUARD** 00.580.2722

Description: Pneumatic spring for SM102 safety guard

Size: 420 mm/ 16 1/2"

Packing: 1 piece

# FOUNT FILTER

**Code: FOUNTFILT01** 63.196.1911

**Model: All models SM/CD/XL**

Description: Filter for fount cooling device

Packing: 1 piece



# HEIDELBERG - OIL AND AIR FILTERS

## Code: OILFILTHS

Description: Main oil filter for Speedmasters  
Packing: 1 piece



## Code: OILFILTHL 00.580.1558/02

Description: Main oil filter for Speedmasters  
Packing: 1 piece



## Code: OILFILT246 00.581.0246/02

Description: Main oil filter cartridge (WG958) for SM52/102-CS92-SX52/102-CD74/102 XL75/105/106/145/162-Primefire 106  
Packing: 1 piece



## Code: AFH5379 00.580.5379

Description: Air filter SF-960255 for SM/CD/CX/SX/XL presses.  
Packing: 1 piece



Old Code: AIRFILTHL

## Code: AFH6146 00.580.6146

Description: Air filter FA001105 for SM/CD/CX/SX/XL presses.  
Packing: 1 piece



Old Code: AIRFILTHS

## Code: AFH4992 00.580.4992

Description: Air filter for all SM/CD/CX/SX/XL presses  
Packing: 1 piece



## Code: AFH3702 00.780.3702

Description: Air filter for spray powder unit for SM/CD/CX/SX/XL presses.  
Packing: 1 piece



## Code: AFH1510 L8.164.1510 /WEKO 32150

Description: Air filter for spray powder unit for SM/CD/CX/SX/XL presses.  
Packing: 1 piece



## Code: AFH8106 47.018.106

Description: Air filter 730.512 for SM74/CD74/SM102/CD102/SX/CX/XL presses.  
Packing: 1 piece





# HEIDELBERG - SHEET SMOOTHER (SHEET HOLD DOWNS)

**Code: HSHSC**

**Model: SM102/SM74/SM72/S-Offset**

Description: Sheet smoother - small  
Complete unit with holder

Packing: 1 piece



**Code: HSHLC** 66.072.084F

**Model: SM102/SM74/SM72/S-Offset**

Description: Sheet smoother - large  
Complete unit with holder

Packing: 1 piece



**Code: HSHLLCR** C4.372.384F

**Model: SM102/SM74/SM72/S-Offset**

Description: Sheet smoother - lateral right  
Complete unit with holder

Packing: 1 piece



**Code: HSHLLCL** C4.372.383F

**Model: SM102/SM74/SM72/S-Offset**

Description: Sheet smoother - lateral left  
Complete unit with holder

Packing: 1 piece

**Code: HSHNC210** 66.072.089F

**Model: SM102/SM74/SM72/S-Offset**

Description: Sheet smoother - narrow - 210mm  
Complete unit with holder

Packing: 1 piece

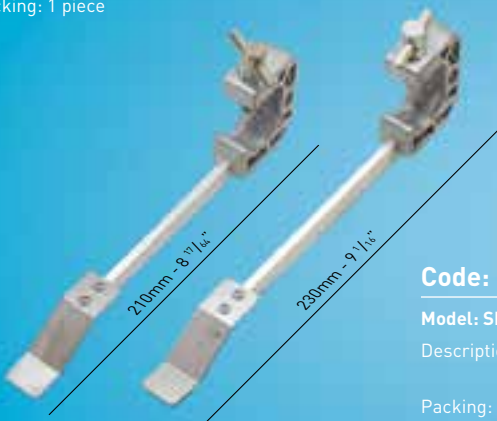

**Code: HSHNCR** 66.072.082F

**Model: SM102**

Description: Sheet Smoother  
Lateral Right Cpl.  
unit with holder

Packing: 1 piece



**Code: HSHNCL** 66.072.080F

**Model: SM102**

Description: Sheet Smoother  
Lateral Left Cpl.  
unit with holder

Packing: 1 piece

**Code: HSHNC230** 66.891.001F

**Model: SM102/SM74/SM72/S-Offset**

Description: Sheet smoother - narrow - 230mm  
Complete unit with holder

Packing: 1 piece

## HEIDELBERG - SHEET SMOOTHER (SHEET HOLD DOWNS)

**Code: HSHS** 58.022.396

**Model: : SM102/SM74/SM72/S-Offset**

Description: Sheet smoother - small

Packing: 1 piece



**Code: HSHL** 66.072.096

**Model: : SM102/SM74/SM72/S-Offset**

Description: Sheet smoother - large

Packing: 1 piece

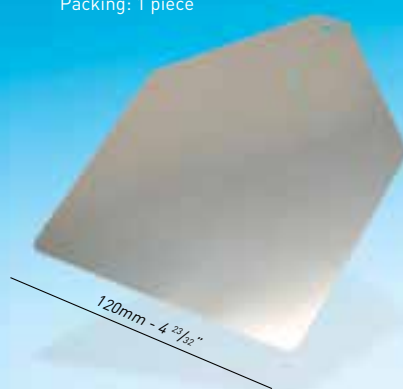

**Code: HSHLL**

**Model: : SM102/SM74/SM72/S-Offset**

Description: Sheet smoother - lateral

Packing: 1 piece



## HEIDELBERG - SHEET STOPS (GUIDE STRAPS)

**Code: GSGT04652**

Description: Sheet stop for GT046/GT052

Packing: 1 piece



**Code: GSKORD64**

Description: Sheet stop for KORD64

Packing: 1 piece



**Code: GSKORD64F**

Description: Sheet stop with top finger for KORD64

Packing: 1 piece



## HEIDELBERG - O-RINGS

**Code: ORM0GT0**

**Model: MO/GT0** 00.580.1069

Inside dia.: 46mm/1 13/16"

Packing: 6 pcs/pack



**Code: ORSM52**

**Model: SM52** 00.580.4270

Inside dia.: 62mm/2 7/16"

Packing: 6 pcs/pack



**Code: OR1026953**

**Model: SM102/CD102** 00.580.6953

Inside dia.: 68mm/2 11/16"

Packing: 6 pcs/pack



**Code: OR1021617**

**Model: SM102 (old)/SM72** 00.580.1617

Inside dia.: 80mm/3 1/32"

Packing: 6 pcs/pack



# HEIDELBERG - PARTS FOR PLATEN T AND GT

## Code: SHEETGTC

Description: Centre sheet separator, forked for T and GT

Thickness: 0.1mm/0.004"

Packing: 1 piece

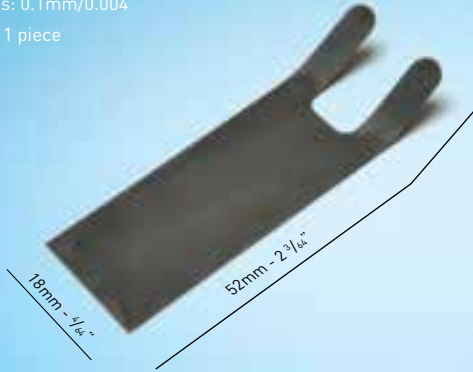

## Code: SHEETGTL

Description: Lateral spring, long for T and GT

Packing: 1 piece

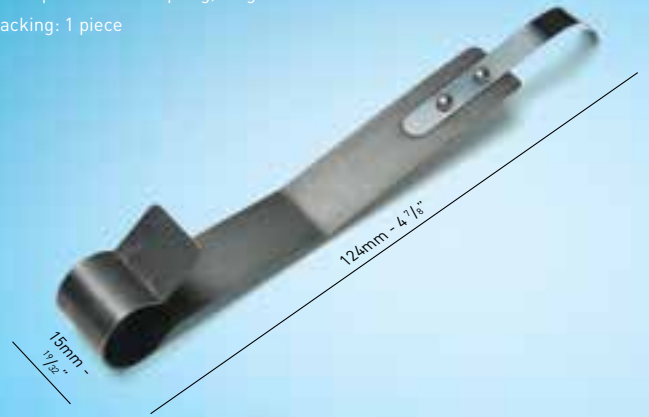

## Code: HEID33

Description: Wash-up blade for Platen T 10"x15"

Size: 390 x 51 x 6mm - 5 slots  
15 23/64" x 2 1/64" x 15/64"

Packing: 1 piece



## Code: HEID34

Description: Wash-up blade for Platen GT 13"x18"

Size: 470 x 51 x 6mm - 6 slots  
18 1/2" x 2 1/64" x 15/64"

Packing: 1 piece



# HEIDELBERG - TOOLS FOR GTO/MO/72/74/102

## Code: TLE 44117

Size: 4 x 117 x 4mm



## Code: TLE 64150

Size: 6 x 150 x 4mm



## Code: TLE 68225

Size: 6 x 225 x 8mm



## Code: TLC 8210

Size: 210 x 8mm



## Code: TLE 66245

Size: 6 x 245 x 6mm



## Code: TLE 88245

Size: 8 x 245 x 8mm



## Code: TLE 1010300

Size: 10 x 300 x 10mm



## Code: TLB 10233

Size: 233 x 10mm



## Code: TLC 114210

Size: 4 x 210 x 11mm



# HEIDELBERG - PARTS FOR PLATEN T AND GT

Code:	
<b>LP02146</b>	Lay Pins 35mm/1 3/8"
<b>LP02147</b>	Lay Pins 45mm/1 49/64"
<b>LP02148</b>	Lay Pins 55mm/2 11/64"
<b>LP02149</b>	Lay Pins 65mm/2 9/16"
<b>LP02150</b>	Lay Pins 75mm/2 61/64"

Packing: 25 pcs/bag

## FLAT SIDE SHEET SEPARATORS

**Code: SHEET333435**

Description: One complete set

Packing: 4 pcs/90 x 6 x 0.15mm  
2 pcs/120 x 6 x 0.20mm  
2 pcs/150 x 6 x 0.30mm



**Code: SHEET1233** 90 x 6 x 0.15mm

**Code: SHEET1234** 120 x 6 x 0.20mm

**Code: SHEET1235** 150 x 6 x 0.30mm

Packing: 12 pcs/pack



**Code: CJHGT**

Description: Cutting jacket  
Platen GT 13"x18"

Packing: 1 piece



**Code: CJHT**

Description: Cutting jacket  
Platen T 10"x15"

Packing: 1 piece

# Wash-up bottles, sponges, blanket scrubbers, wiper pads, steel and brass brushes

## Code: WU16

Description: Wash-up bottle - 500 ml/16 oz

Packing: 1 piece

## Code: WU32

Description: Wash-up bottle - 1 liter/32 oz

Packing: 1 piece

New flexible nozzle / cap



All supplied in a box with 4 bottles



## Flexible nozzle

This 1 liter bottle - clear with small cap has a flexible nozzle/straw.

## Code: WU1000

Description: Wash-up bottle - clear with straw - 1 liter/32 oz

Packing: 1 piece

## Code: WU32S

Description: 1 set comprising 4 bottles and 7 caps with straws:

4 red, 1 yellow, 1 blue, 1 black

Packing: 1 set/box

## VISKOVITA SPONGES

### Code: VSPON

This 115x35mm compressed cellulose sponge swells to a handy 150 x100mm. Highly durable it does not break down even after prolonged use with pressroom chemicals.

Packing: 1 piece wrapped in cellophane



## BLANKET SCRUBBER

The Blanket Scrubber effortlessly cleans off ink, gum, varnish, paper lint, clay and spray powder from the blanket as well as rollers and press frames.

The Blanket Scrubber is an open mesh nylon pouch containing a cellulose sponge.

The scrubbing action of the Blanket Scrubber completely cleans and rejuvenates the blanket surface.

One scrubber will replace hundreds of shop towels.

Simply soak the Blanket Scrubber in your favorite blanket wash, squeeze out excess liquid and it is ready to use.

### Code: SCRUBBERM

Description: Blanket Scrubber Medium - Green

Size: 114x159mm/4 31/64" x 6 17/64"

Packing: 6 pcs/pack

### Code: SCRUBBERXL

Description: Blanket Scrubber Large - Green

Size: 140x180mm/5 33/64" x 7 3/32"

Packing: 6 pcs/pack



## WIPER PAD

### Code: WIPERPAD

Description: Wiper Pad - White

Size: 75x175x125mm

Packing: 1 piece/pack



## STEEL AND BRASS BRUSHES

### Code: BRUSHSTEEL

Description: Steel Brush for cleaning ceramic anilox rollers

Size: 110 x 60mm - 4 21/64" x 2 23/64"

Packing: 1 piece/box

### Code: BRUSHBRASS

Description: Brass Brush for cleaning chrome anilox rollers

Size: 110 x 60mm - 4 21/64" x 2 23/64"

Packing: 1 piece/box



# Grippers and Gripper Pads



# GRIPPERS AND GRIPPER PADS

## Code: ZF2581727

OEM: F2.581.727  
 Model: XL105 Impression  
 Hooked gripper - Urethane



## Code: ZC3011727

OEM: C3.011.727  
 Model: SM102/CD102 Impression/Transfer  
 Gripper - Urethane



## Code: ZC3581627N

OEM: C3.581.627N (later model)  
 Model: SM102 Impression  
 Hooked gripper - Steel



## Code: Z49011027

OEM: 49.011.027 (early model)  
 Model: SM102 Impression/Transfer  
 Hooked gripper - Steel



## Code: Z91580337

OEM: 91.580.337  
 Model: SM102/SM72 Upper Pincer



## Code: ZF4005126

OEM: F4.005.126  
 Model: XL105 Transfer  
 Winged gripper - Urethane



## Code: ZC3011627

OEM: C3.011.627  
 Model: SM102/CD102 Impression/Transfer  
 Gripper - Steel



## Code: Z91581827N

OEM: 91.581.827N (early model)  
 Model: SM102/SM72 Impression  
 Hooked gripper - Urethane



## Code: Z82582727N

OEM: 82.582.727N (later model)  
 Model: SM102 Double Drum  
 Hooked gripper - Urethane



## Code: Z91580338

OEM: 91.580.338 / 82.583.338  
 Model: SM102/SM72  
 Lower Pincer gripper - Steel



## Code: ZF4005125

OEM: F4.005.125  
 Model: XL105 Transfer  
 Winged gripper - Urethane



## Code: ZC3581727N

OEM: C3.581.727N (later model)  
 Model: SM102 Impression  
 Hooked gripper - Urethane



## Code: Z49011827F

OEM: 49.011.827F (early model)  
 Model: SM102/SM72 Impression/Transfer  
 Gripper - Urethane



## Code: Z82582627N

OEM: 82.582.627N (later model)  
 Model: SM102 Double Drum  
 Hooked gripper - Steel



## Code: Z27013049

OEM: 27.013.049F  
 Model: SM102/SM72/SO/MO Ranger Drum  
 Gripper - Urethane





# GRIPPERS AND GRIPPER PADS

## Code: Z93014307

OEM: 93.014.307  
 Model: SM102/CD102 Delivery  
 Gripper Finger



## Code: ZM4011727

OEM: M4.011.727  
 Model: SM74/SM52 Impression/Transfer  
 Gripper - Urethane



## Code: Z43020035 (old code: GTO4302035)

OEM: 43.020.035F  
 Model: GTO/MO/KORD Feed Table  
 Gripper - Rubber pad w/air hole



## Code: Z52580363

OEM: 52.580.363  
 Model: GTO/MO Lower Pincer  
 Gripper - half grip - Steel



## Code: Z69011827

OEM: 69.011.827  
 Model: GTO Impression/Transfer  
 Gripper - Urethane



## Code: ZM2583637

OEM: M2.583.637  
 Model: SM74/PM74/SM52 Upper Pincer  
 Gripper - Urethane



## Code: Z69011727B

OEM: 69.011.727 (old model)  
 Also refer to Z69011827  
 Model: MO Transfer  
 Gripper - Urethane

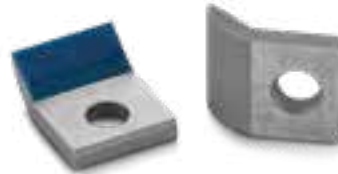

## Code: Z43020035NH (old code: GTO2035F)

Description: Same as 43.020.035F  
 w/out air hole  
 Model: GTO/MO/KORD Feed Table  
 Gripper - Rubber pad



## Code: Z79580637

OEM: 79.580.637  
 Model: GTO/MO Upper Pincer  
 Gripper - full grip - Urethane



## Code: Z69011727

OEM: 69.011.727  
 Model: GTO Impression/Transfer  
 Gripper - Steel



## Code: ZM2583398

OEM: M2.583.398  
 Model: SM74/PM74/SM52 Lower Pincer  
 Gripper - Steel



## Code: Z52581027

OEM: 52.581.027  
 Model: GTO/MO Impression/Transfer  
 Hooked gripper - Urethane



## Code: Z79580662

OEM: 79.580.662  
 Model: GTO/MO Upper Pincer  
 Gripper - half grip - Urethane



## Code: Z52580338

OEM: 52.580.338  
 Model: GTO/MO Lower Pincer  
 Gripper - full grip - Steel



## Code: ZL4014003

OEM: L4.014.003/05  
 Model: SM74/CD74/XL75/XL105 Delivery  
 Gripper - Steel



**Code: ZM2014011**

OEM: M2.014.011  
 Model: SM74 Delivery  
 Hooked gripper, right - Steel

**Code: Z14875001NR** (old code: KORD7501NR)

Model: SM52/GTO/KORD Delivery  
 Gripper - Without rubber pad

**Code: Z03014051** (old code: S1451F)

OEM: 03.014.051F  
 Model: S/SB/SBG/SBD Carriage  
 Gripper - Rubber pad

**Code: ZC3011820C**

OEM: C3.011.820  
 Model: SM102/CD102 - Cross groove

**Code: ZC3581920**

OEM: C3.581.920  
 Model: CD102 - T-Shaped -  
 Diamond groove

**Code: ZM2015004**

OEM: M2.015.004  
 Model: SM74 Delivery  
 Hooked gripper, left - Steel

**Code: Z43014004**

OEM: 43.014.004  
 Model: MO Delivery  
 Gripper - Urethane

**Code: ZC3011920**

OEM: C3.011.920  
 Model: SM102/CD102 - Diamond groove

**Code: Z93525310**

OEM: 93.525.310  
 Model: SM102/CD102

**Code: Z91581620**

OEM: 91.581.620  
 Model: SM102/SM72 - T-Shaped -  
 Cross groove

**Code: Z14875001** (old code: GTO1487501)

OEM: 14.875.001F  
 Model: SM52/GTO/KORD Delivery  
 Gripper - Rubber pad

**Code: Z14014041**

OEM: 14.014.041  
 Model: GTO/KORD Delivery  
 Backing Plate

**Code: ZC3011820**

OEM: C3.011.820  
 Model: SM102/CD102 - Parallel groove

**Code: Z58711101**

OEM: 58.711.101  
 Model: SM102/CD102/SO - Cross groove



# Ink Knives

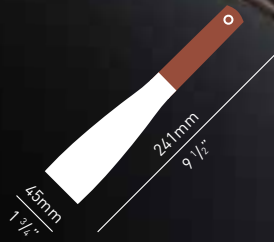

Code: KNIFEMT45



Code: KNIFEMT60

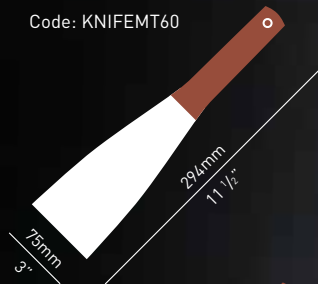

Code: KNIFEMT75

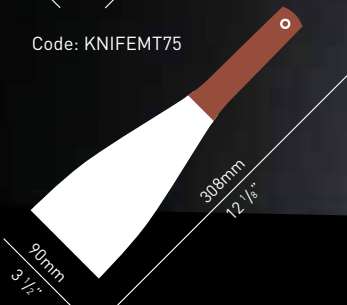

Code: KNIFEMT90

## INK KEYS

Code: **INKKEY**

### Ink Key Large

Ink key for standard vacuum ink cans  
Packing: 10 pcs/box



Code: **INKKEYS**

### Ink Key Small

Ink key for Japanese and small ink cans  
Packing: 10 pcs/box



## PLASTIC INK KNIVES

### Code: KNIFE

4 knives/box - 25 boxes/carton  
270 x 70mm (10 3/4" x 2 3/4")  
Yellow, red, blue and black

Print name or logo  
with order of  
500+ sets

World Ink Corporation  
1-800-888-8888

## WHITE FLEXIBLE PLASTIC INK KNIFE

### Code: KNIFEJ

White flexible plastic ink knife  
300 x 80mm (11 3/4" x 3 1/8")  
Packing: 1 piece





# Paper Wedges

# Aluminium Paper Pile Corners

Precision cut to exact height and uniformly bent

- Conveniently punched holes for easy handling
- Rounded corners and edges to protect hands and fingers
- Space saving - easily stacked and stored in a cabinet

Code	Size (inch)
<b>PPCRNR6X5</b>	<b>6" x 5"</b>
<b>PPCRNR9X5</b>	<b>9" x 5"</b>

Packing: 8 pcs/box



# PAPER WEDGES



All 3 models are also offered individually.

**Code: WEGL** Large wedge  
**Size (LxWxH)** 200 x 80 x 25 mm  
 7 7/8" x 3 5/32" x 1"

**Code: WEGM** Medium wedge  
**Size (LxWxH)** 200 x 60 x 30 mm  
 7 7/8" x 2 23/64" x 1 1/4"

**Code: WEGS** Small wedge  
**Size (LxWxH)** 200 x 30 x 30 mm  
 7 7/8" x 1 5/16" x 1 1/4"

**Combi Pack**  
**Code: WEGC1** 1 small, 1 medium, 1 large wedge

**Code: WEGB** Baby wedge  
**Size (LxWxH)** 100 x 33 x 29 mm  
 3 15/16" x 1 19/64" x 1 9/64"  
 Packing: 4 pcs/box



**Combi Pack**  
**Code: WEGC2** 2 large wedges  
 Packing: 2 pcs/box



# REEL CUTTER

**Code: RCUT** Large wedge  
**Size (LxH)** 245 x 95 mm  
 9 1/2" x 3 5/8"  
 Packing: 1 piece



**Combi Pack**  
**Code: WEGC3** 2 small, 2 medium wedges



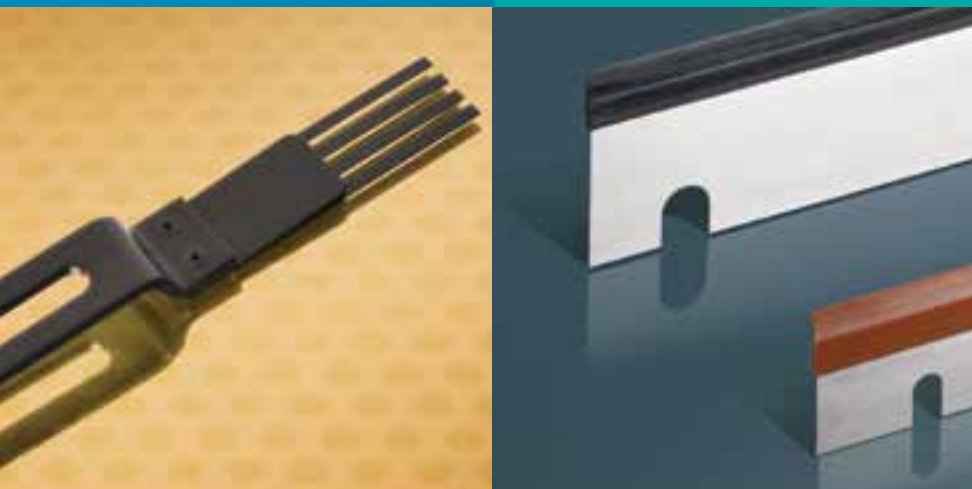
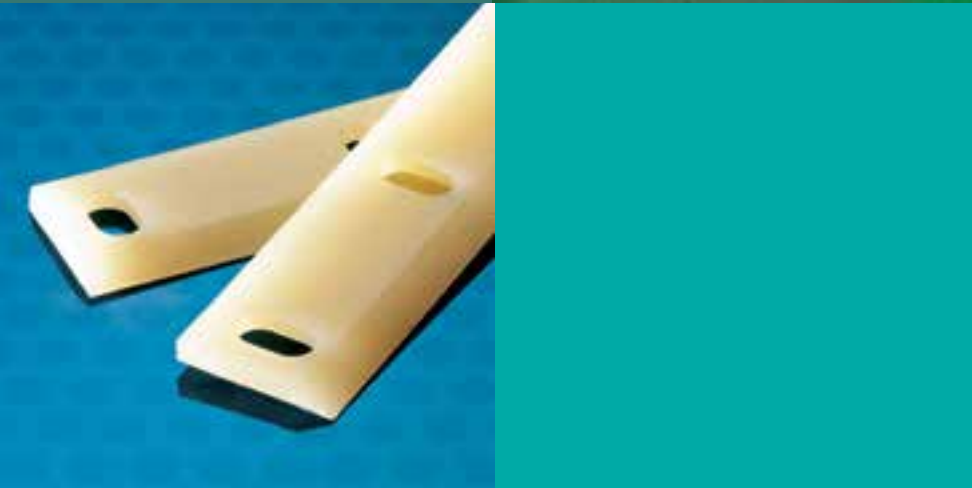

### **7553**

Illuminated Microscope with focus and **50X magnification.**

This model is produced in black and clear hard durable plastic and delivered in individual black vinyl pouches in printed cardboard boxes.



**7553**

### **OPENBRIG 10X**

Openbrig magnifying glass with **10X magnification.**

The Openbrig magnifying glass is produced in strong black and clear PVC and delivered in individual round vinyl pouch with zipper.



**OPENBRIG10X**

### **MEASURING GLASS 10X**

Measuring magnifying glass with **10X magnification.**

The measuring glass has an aluminium stand with a glass bottom, showing millimeter measurements. It is produced in strong black plastic with optical lens and delivered in individual cardboard boxes.



**MGLASS10X**

# Magnifying Glasses

All magnifying glasses can be delivered with name and logo printed on the magnifying glass.  
Minimum order for printing is 500 pieces of individual models.

MAG6X, MAG8X and MAG10X are produced in black lacquered metal with two optical glass lenses in small individual vinyl pouches



## **MAG6X**

Large magnifying glass with **6X magnification**



## **MAG8X**

Medium magnifying glass with **8X magnification**



## **MAG10X**

Small magnifying glass with **10X magnification**



## **MAGLIGHT10X**

Magnifying glass with **10X magnification** with light and measuring scale in mm and inches. Supplied in a vinyl pouch with batteries being optional.



## **MAGSOL6X**

Large magnifying glass with **6X magnification**. Solid back - giving extra space for company name, logo or general advertising. This model is produced in black lacquered metal with one optical glass lens. Supplied in vinyl pouch.





# Cutting Sticks

## CUTTING STICKS FOR GUILLOTINES AND THREE KNIFE TRIMMERS

Complete in-house design and production capabilities allows us a high level of control every step of the way. Skilled chemists and engineers work together to ensure the finished products meet the needs of our customers.

*Master* Cutting Sticks are manufactured in modern production facilities to original equipment manufacturer specifications with tolerances of +/- 0.025mm (+/- 0.001") and our engineering staff select materials that optimize the performance and durability of all products.

All cutting sticks are manufactured with virgin plastic compounds formulated for each application and comply with world-wide environmental regulations.

### General Product Guide

Material	Colour	Quality	Hardness Shore "D"	Application
uPVC	Red	Original	80-82	Standard steel knives
HDPE	Green Or White	Economy	67-68	All knives except TCT
PP	Grey Or Red	Universal	72-75	All knives
Nylon	White	Premium	80-83	HSS & TCT knives



**B**

PP or Nylon cutting sticks with 2 beveled edges for certain Kolbus trimmers.

**BS**

**4H**

4H are cutting sticks with 4 holes in each end for IDEAL guillotines.

**QR1**

**QR2**

QR1 & QR2 are "Quick Release" cutting sticks for IDEAL 4205, 4215 and 4250 as well as 4305, 4315, 4350 and 4705 cutting machines.

**SPECIAL SIZES**



Each pack of cutting sticks is clearly labeled with a product code describing type of material, size and length for easy identification.

# Mag Pads



An inexpensive way to protect your delicate paper stock (like NCR and carbon) from marks or damages often caused by guillotine clamps.

Also excellent for protecting products with uneven surfaces such as perfect bound booklets.

The high density foam pad prevents sharp edges of the clamp fingers from marking the stock.

The Mag Pad is securely held in place on the clamp during cutting by the tough magnetic rubber surface lining the back side of the pad.

Quick and easy to use. This Mag Pad will not damage the knife if cut into - making it a perfectly safe product to use.

**Code: MAGPAD381X76**

Size: 381x76mm (15"x 3")

Packing: 2 pads/pack

# Knife Guards

## For Guillotines and 3-Knife Trimmers

Our heavy duty knife guards ensure excellent protection of the knife edge off and on the machine, during servicing of the machine as well as when transporting the knife.

The knife guard is made of thick, durable, red UPVC, equipped with a wide magnetic strip and formed to ensure the knife guard is held securely in place on the knife.

Black and yellow safety hazard strips are applied on both sides for increased safety. Supplied cut to size or in 2 meter length for local sizing. Order knife guards 20-30mm longer than the length of the knife.

Knife guards can also be supplied with end stops/screws according to customer specifications.

### Code: KGUARD

Size: 60mm width in any length up to 2 meter

Packing: 1 piece supplied in plastic sleeve

### Frequently ordered sizes:

Code	Length
<b>KGUARD380</b>	380mm
<b>KGUARD400</b>	400mm
<b>KGUARD430</b>	430mm
<b>KGUARD440</b>	440mm
<b>KGUARD450</b>	450mm
<b>KGUARD470</b>	470mm
<b>KGUARD480</b>	480mm
<b>KGUARD560</b>	560mm
<b>KGUARD570</b>	570mm
<b>KGUARD585</b>	585mm
<b>KGUARD590</b>	590mm
<b>KGUARD600</b>	600mm
<b>KGUARD610</b>	610mm
<b>KGUARD700</b>	700mm
<b>KGUARD1000</b>	1000mm
<b>KGUARD1100</b>	1100mm
<b>KGUARD1200</b>	1200mm
<b>KGUARD1400</b>	1400mm
<b>KGUARD1450</b>	1450mm
<b>KGUARD1500</b>	1500mm
<b>KGUARD1700</b>	1700mm
<b>KGUARD1800</b>	1800mm

# Jogger Blocks

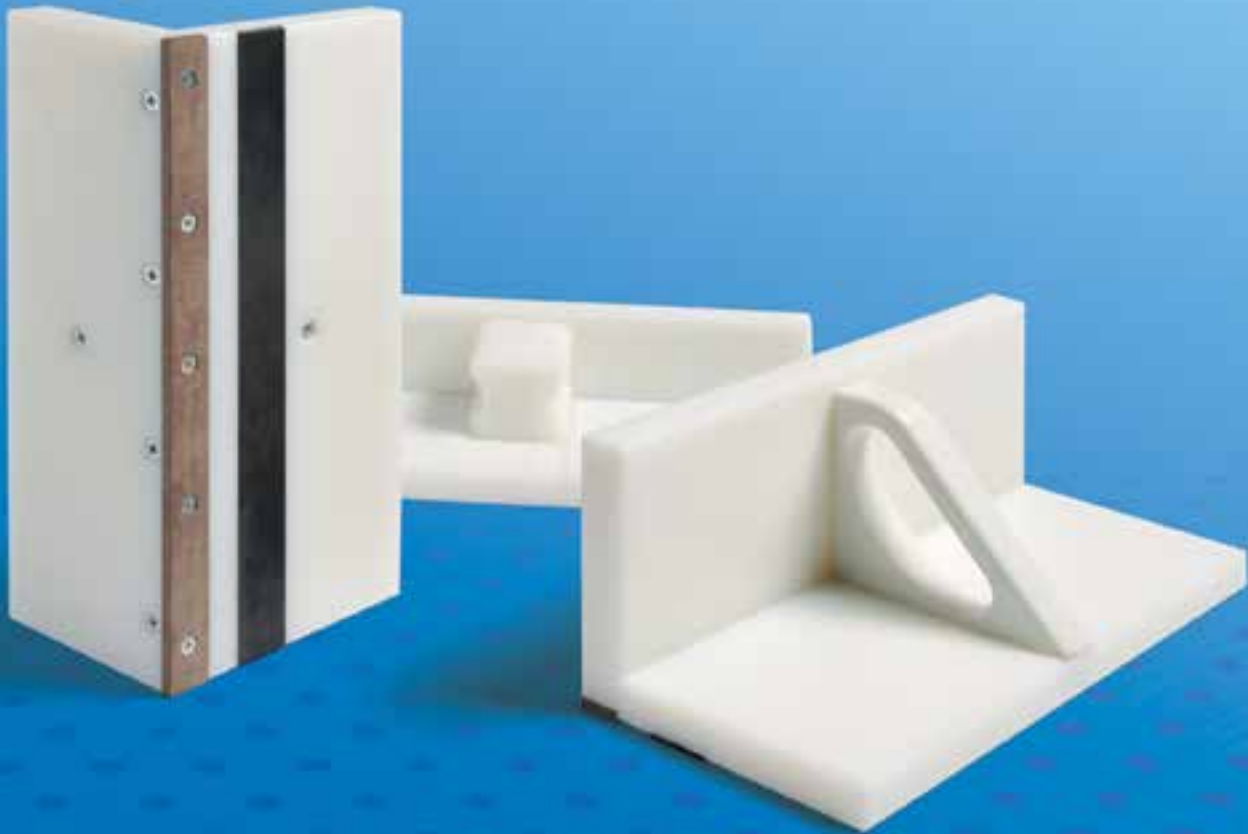

*Master Jogger Blocks* are made in tough, durable HDPE plastic and come with a Tufnell wear strip ensuring bottom sheet accuracy is maintained throughout the jogger blocks long working life.

Each jogger block is equipped with a magnetic strip in the base to help jog bottom sheets perfectly.

All medium and large jogger blocks are supplied with the “pistol grip” handle for comfortable long term use.

This unique grip handle is not only more comfortable to use but also much stronger than the standard round “pin” handle in case the jogger block is accidentally dropped.

Each jogger block is thoroughly tested before shipment and packed individually in a strong box with padding.

<b>Code</b>	<b>Height x Length</b>
-------------	------------------------

With comfortable block handle

**JB75X250** 75 x 250mm

**JB75X300** 75 x 300mm

**JB100X200** 100 x 200mm

**JB100X250** 100 x 250mm

**JB100X300** 100 x 300mm

With pistol grip handle

**JB125X250** 125 x 250mm

**JB125X300** 125 x 300mm

**JB125X400** 125 x 400mm

**JB150X300** 150 x 300mm

**JB150X400** 150 x 400mm

**JB150X450** 150 x 450mm

**JB150X600** 150 x 600mm

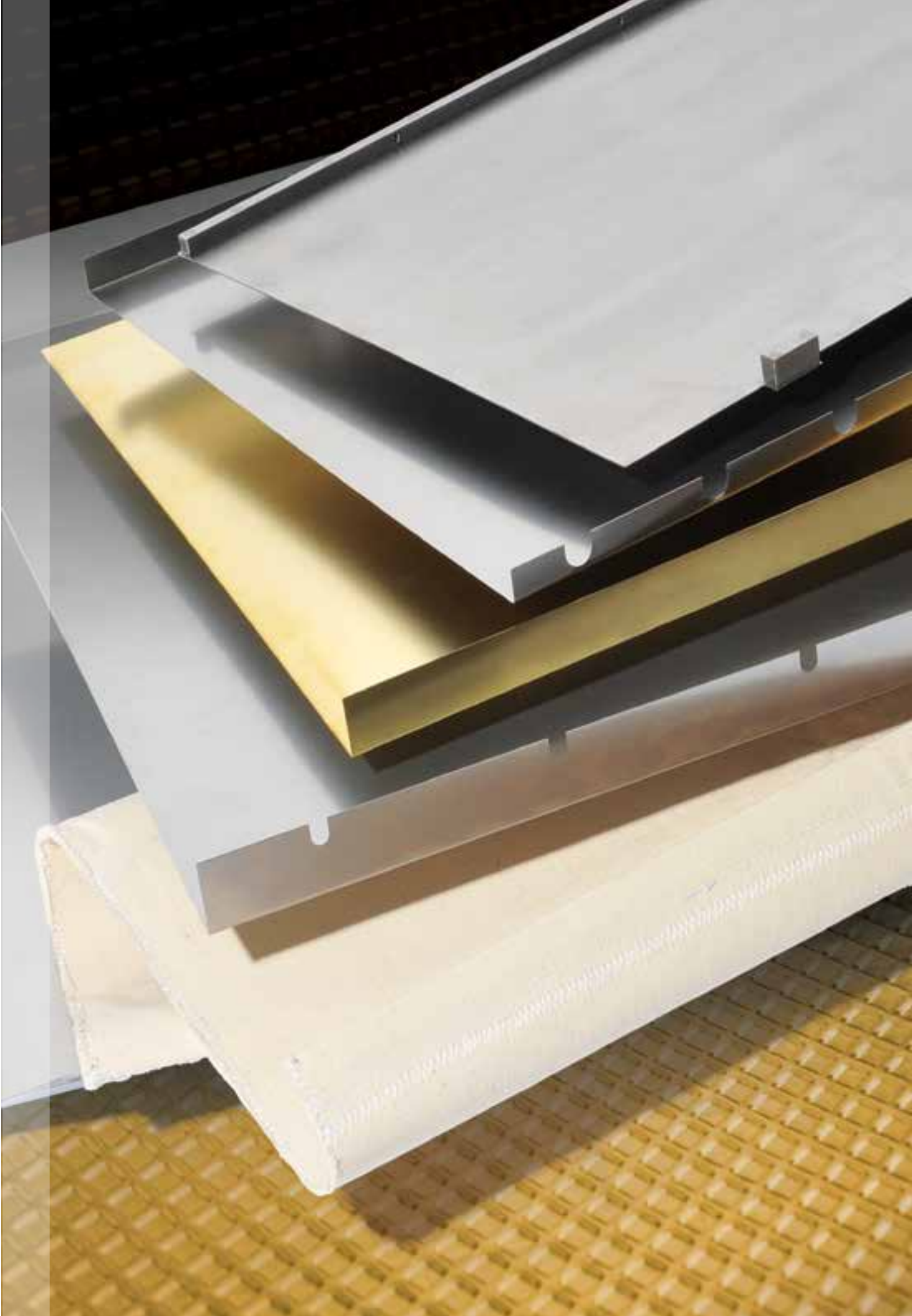



# Cylinder Jackets

JACKET THICKNESS 0.30MM/0.012"

				MM			INCH		
MACHINE TYPE	CODE	MODEL	MATERIAL	THK	MACHINE SIZE		THK	MACHINE SIZE	
<b>HEIDELBERG</b>	CJBHPM46	PM 46/QM46	BRASS	0.3	340	460	0.012	13 25/64	18 7/64
	CJHPM46	PM 46/QM46	STEEL	0.3	340	460	0.012	13 25/64	18 7/64
	CJBHGT046	GTO 46	BRASS	0.3	320	460	0.012	12 19/32	18 7/64
	CJNHGT046	GTO 46	NYLON	0.5	320	460	0.020	12 19/32	18 7/64
	CJHGT046	GTO 46	STEEL	0.3	320	460	0.012	12 19/32	18 7/64
	CJBHGT052	GTO 52/PM 52	BRASS	0.3	360	520	0.012	14 11/64	20 15/32
	CJNHGT052	GTO 52/PM 52	NYLON	0.5	360	520	0.020	14 11/64	20 15/32
	CJHGT052	GTO 52/PM 52	STEEL	0.3	360	520	0.012	14 11/64	20 15/32
	CJHSM52	SM 52	STEEL	0.3	360	520	0.012	14 11/64	20 15/32
	CJBHSM52	SM 52	BRASS	0.3	360	520	0.012	14 11/64	20 15/32
	CJNHSM52	SM 52	NYLON	0.5	360	520	0.020	14 11/64	20 15/32
	CJHMO	MO 65	STEEL	0.3	480	650	0.012	18 57/64	25 19/32
	CJHSM72	SM 72	STEEL	0.3	520	720	0.012	20 15/32	28 11/32
	CJHSM74	SM 74	STEEL	0.3	520	740	0.012	20 15/32	29 9/64
	CJHSM102	SM 102 = SORS	STEEL	0.3	720	1020	0.012	28 11/32	40 5/32
<b>DAVIDSON</b>	CJD501	501	STEEL	0.3	350	500	0.012	13 25/32	19 11/16
<b>FUJI- SHINOHARA</b>	CJF52	FUJI-52	STEEL	0.3	360	520	0.012	14 11/64	20 15/32
	CJF66	FUJI-66	STEEL	0.3	480	660	0.012	18 57/64	25 63/64
	CJF75	FUJI-75	STEEL	0.3	580	750	0.012	22 53/64	29 17/32
<b>KOMORI</b>	CJKS26	SPRINT 26	STEEL	0.3	460	680	0.012	18 7/64	26 49/64
	CJKS28	SPRINT 28	STEEL	0.3	520	720	0.012	20 15/32	28 11/32
<b>ROLAND</b>	CJRPR00	PRAKTIKA 00	STEEL	0.3	360	520	0.012	14 11/64	20 15/32
	CJRPR00N	PRAKTIKA 00 (NEW)	STEEL	0.3	360	520	0.012	14 11/64	20 15/32
<b>SAKURAI</b>	CJS52	OLIVER 52	STEEL	0.3	360	520	0.012	14 11/64	20 15/32
	CJS58	OLIVER 58-258	STEEL	0.3	440	580	0.012	17 21/64	22 53/64
	CJS66	OLIVER 66	STEEL	0.3	460	660	0.012	18 7/64	25 63/64
	CJS72	OLIVER 72	STEEL	0.3	520	720	0.012	20 15/32	28 11/32

JACKET THICKNESS 0.60MM/0.024"

				MM			INCH		
MACHINE TYPE	CODE	MODEL	MATERIAL	THK	MACHINE SIZE		THK	MACHINE SIZE	
<b>HEIDELBERG</b>	CJHKOR	KOR	STEEL	0.6	400	570	0.024	15 3/4	22 7/16
	CJHKORA	KORA 57	STEEL	0.6	460	570	0.024	18 7/64	22 7/16
	CJHKORD62	KORD 62	STEEL	0.6	460	620	0.024	18 7/64	24 7/16
	CJHKORD64	KORD 64	STEEL	0.6	460	640	0.024	18 7/64	25 13/64
	CJHKORS	KORS 72	STEEL	0.6	520	720	0.024	20 15/32	28 11/32
	CJHT	PLATEN T	STEEL	0.8	254	380	0.031	10	15
	CJHGT	PLATEN GT	STEEL	0.8	330	457	0.031	13	18
	CJHKS	KS	STEEL	0.6	380	520	0.024	14 61/64	20 15/32
	CJHKSB	KSB	STEEL	0.6	400	570	0.024	15 3/4	22 7/16
	CJHKSBBA	KSBA	STEEL	0.6	460	585	0.024	18 7/64	23 1/32
	CJHKSBBAZ	KSBAZ	STEEL	0.6	460	570	0.024	18 7/64	22 7/16
	CJHKSD	KSD	STEEL	0.6	460	640	0.024	18 7/64	25 13/64
	CJHS	S (OHZ)	STEEL	0.6	540	720	0.024	21 17/64	28 11/32
	CJHSB-SBG	SB-SBG	STEEL	0.6	560	770	0.024	22 3/64	30 5/16
	CJHSBG-SP	SBG (SPECIAL)	STEEL	0.6	540	770	0.024	21 17/64	30 5/16
	CJHSBB	SBB	STEEL	0.6	570	820	0.024	22 7/16	32 9/32
	CJHSBD	SBD	STEEL	0.6	632	894	0.024	24 7/8	35 13/64
	CJHSBD-SP	SBD (SPECIAL)	STEEL	0.6	640	900	0.024	25 13/64	35 7/16



**M**

HEID14 - Heidelberg SM102/CD102 - Metal/Rubber

**U**

UMITSUBISHI41 - Mitsubishi 3FH/Diamond 3000

**P**

ROLAND25 - Roland

# Wash-up Blades

Our wash-up blades are manufactured to fine tolerances for perfect fit on old and new presses alike. They are resistant to chemical attack from inks and solvents and are highly efficient and durable.

A perfect profile ensures excellent wash-up results each time, reducing the amount of wash-up chemicals used and reducing down-time on the press.

Our blades are available for the vast majority of offset sheet-fed, web and continuous form presses in either metal/rubber, metal/urethane, rubber (EPDM), plastic or Tufnol format. Each individual blade is presented in a plastic sleeve with the machine reference for easy identification.

- Size and style specification guaranteed
- High resistance to wear
- Accurate fit first time - no adjustment required
- Corrosion-proof steel
- Chemical resistant rubber and plastic
- Individually packed in protective sleeve
- Moulded rubber tip chemically bonded - no breakdown



- Metal/Urethane

d 700 - Plastic

OLIVER04 - Oliver 66 - EPDM Rubber

C

HEID34 - Heidelberg Platen GT - Metal/Rubber Combination

T

HEID84 - Heidelberg KS - Tufnol

HEIDELBERG				MM			INCHES			
Part No	Machine	Model	Type	Length	Width	Thk	Length	Width	Thk	No Holes
HEID01	Heidelberg	TOK (plastic)	P	283	43	3.0	11 9/64	1 11/16	1/8	4
HEID02	Heidelberg	TOK (metal)	M	283	43	0.5	11 9/64	1 11/16	1/64	4
HEID03	Heidelberg	Quickmaster	P	375	43	3.0	14 49/64	1 11/16	1/8	5
HEID04	Heidelberg	GTO 46	M	500	60	0.5	19 11/16	2 23/64	1/64	5
HEID35	Heidelberg	GTO 46 Numbering Unit	C	448	40	6.0	17 41/64	1 37/64	15/64	3
HEID05	Heidelberg	GTO 52/PRINTMASTER	M	560	60	0.5	22 3/64	2 23/64	1/64	6
HEID36	Heidelberg	GTO 52 Numbering Unit	C	508	40	6.0	20	1 37/64	15/64	3
HEID06	Heidelberg	MO and SORK Flexi (standard)	M	710	60	0.5	27 61/64	2 23/64	1/64	8
HEID07	Heidelberg	MO A/W (short)	M	692	60	0.5	27 1/4	2 23/64	1/64	7
HEID56	Heidelberg	MO (rigid)	M	710	60	2.0	27 61/64	2 23/64	5/64	8
HEID37	Heidelberg	MO Numbering Unit	C	648	52	6.0	25 33/64	2 3/64	15/64	3
HEID09	Heidelberg	Speedmaster 52	M	605	46	0.5	23 13/16	1 13/16	1/64	7
HEID59	Heidelberg	Speedmaster 52 Numbering Unit	M	536	28	0.5	21 7/64	1 7/64	1/64	6
HEID10	Heidelberg	Speedmaster 72	M	790	60	0.5	31 7/64	2 23/64	1/64	11
HEID11	Heidelberg	Speedmaster 72 VP	M	753	40	0.5	29 41/64	1 37/64	1/64	9
HEID54	Heidelberg	Speedmaster 72 A/W	M	742	60	0.5	29 7/32	2 23/64	1/64	8
HEID13	Heidelberg	Speedmaster 74 - standard (w/slots)	M	822	57	0.5	32 23/64	2 1/4	1/64	9
HEID08	Heidelberg	PM74 - Printmaster 74 - standard (w/holes)	M	822	57	0.5	32 23/64	2 1/4	1/64	9
HEID64H	Heidelberg	SM74/PM74 combination w/2 rows of holes	M	822	57	0.5	32 23/64	2 1/4	1/64	18
HEID63	Heidelberg	Speedmaster 74 (long + w/slots) special	M	826	57	0.5	32 33/64	2 1/4	1/64	9
HEID57	Heidelberg	Speedmaster CD74/XL75 (long +w/slots)	M	847	47	0.5	33 11/32	1 27/32	1/64	9
HEID12	Heidelberg	Speedmaster 102 and SORS (w/holes)	M	1090	60	0.5	42 29/32	2 23/64	1/64	11
HEID14	Heidelberg	Speedmaster 102+CD102 (w/slots)	M	1090	60	0.5	42 29/32	2 23/64	1/64	11
HEID16H	Heidelberg	CD102/CX102 narrow profile (w/slots)	H	1090	57	0.5	42 29/32	2 1/4	1/64	11
HEID17	Heidelberg	Speedmaster 102 A/W	M	1042	60	0.5	41 1/64	2 23/64	1/64	11
HEID46	Heidelberg	Speedmaster 102 A/W New	M	1042	57	0.5	41 1/64	2 1/4	1/64	11
HEID18	Heidelberg	Speedmaster 102 VP	M	1052	40	0.5	41 27/64	1 37/64	1/64	11
HEID58H	Heidelberg	Speedmaster XL105 (w/slots)	M	1125	41	0.5	44 19/64	1 39/64	1/64	21
HEID38H	Heidelberg	Speedmaster XL145 (rubber profile:1588mm)	M	1588/1758	52	0.5	62 33/64	2 3/64	1/64	18
HEID40H	Heidelberg	Speedmaster XL162	M	1708	52	0.5	67 1/4	2 3/64	1/64	18
HEID60	Heidelberg	SOR Flexi (new model)	M	890	60	0.5	35 1/32	2 23/64	1/64	9
HEID24	Heidelberg	SOR Rigid (old model)	M	890	50	2.0	35 1/32	1 31/32	5/64	10
HEID06	Heidelberg	SORK Flexi and MO	M	710	60	0.5	27 61/64	2 23/64	1/64	8
HEID28	Heidelberg	SORK-65 Rigid	M	721	50	2.0	28 25/64	1 31/32	5/64	12
HEID30	Heidelberg	SORM Rigid	M	790	50	2.0	31 7/64	1 31/32	5/64	12
HEID31	Heidelberg	SORM/Z Flexi Pre 1995	M	753	42	0.5	29 41/64	1 21/32	1/64	9
HEID47	Heidelberg	SORM/Z Flexi (w/9 holes + 2 slots)	M	790	60	0.5	31 7/64	2 23/64	1/64	11
HEID25	Heidelberg	SORD Flexi	M	960	60	0.5	37 51/64	2 23/64	1/64	10
HEID26	Heidelberg	SORD Rigid	M	960	50	2.0	37 51/64	1 31/32	5/64	12
HEID12	Heidelberg	SORS and SM102	M	1090	60	0.5	42 29/32	2 23/64	1/64	11
HEID19	Heidelberg	KOR	M	600	50	2.0	23 5/8	1 31/32	5/64	10
HEID20	Heidelberg	KORA	M	622	50	2.0	24 31/64	1 31/32	5/64	10
HEID21	Heidelberg	KORD 62	M	650	50	2.0	25 19/32	1 31/32	5/64	10
HEID22	Heidelberg	KORD 64	M	690	50	2.0	27 11/64	1 31/32	5/64	12
HEID23	Heidelberg	KORS	M	760	50	2.0	29 59/64	1 31/32	5/64	12
HEID33	Heidelberg	PLATEN 10 x 15	C	390	51	6.0	15 23/64	2	15/64	5
HEID34	Heidelberg	PLATEN 13 x 18	C	470	51	6.0	18 1/2	2	15/64	6

Legend: **M** = Metal with Rubber **P** = Plastic **E** = EPDM Rubber **C** = Combination **T** = Tufnol **B** = Brass **H** = Narrow Profile

ABDICK				MM			INCHES			
Part No	Machine	Model	Type	Length	Width	Thk	Length	Width	Thk	No Holes
ABDICK02	AB Dick	375/9810	E	338	52	3.0	13 5/16	2 3/64	1/8	6
ABDICK03	AB Dick	9810	E	340	57	5.0	13 25/64	2 1/4	13/64	6
ABDICK07	AB Dick	995	E	360	48	5.0	14 11/64	1 57/64	13/64	6
<b>AKIYAMA</b>										
AKIYAMA01	Akiyama	Bestech 28	E	800	47	5.0	31 1/2	1 27/32	13/64	11
AKIYAMA02	Akiyama	Bestech 40	E	1120	55	5.0	44 3/32	2 11/64	13/64	12
AKIYAMA03	Akiyama	Bestech 40	E	1120	45	5.0	44 3/32	1 49/64	13/64	12
AKIYAMA04	Akiyama	Bestech 40-640 IIC	E	1120	70	5.0	44 3/32	2 3/4	13/64	12
AKIYAMA05	Akiyama	Bestech 40-640 IIC	P	1120	70	5.0	44 3/32	2 3/4	13/64	12
<b>ADAST</b>										
ADAST	Refer to: DOMINANT									
<b>BLANK</b>										
BLANK30	Blank	Long blade used for local cutting/punching	E	996	34	5.0	39 7/32	1 11/32	13/64	0
BLANK05	Blank		E	1250	55	5.0	49 7/32	2 11/64	13/64	0
BLANK06	Blank		M	1230	40	0.5	48 27/64	1 37/64	1/64	0
BLANK07	Blank		M	1530	40	0.5	60 1/4	1 37/64	1/64	0
BLANK03	Blank		M	1800	50	0.5	70 55/64	1 31/32	1/64	0
BLANK01	Blank		M	1800	60	0.5	70 55/64	2 23/64	1/64	0
BLANK02	Blank		M	1800	65	0.5	70 55/64	2 9/16	1/64	0
BLANK04	Blank		P	2000	65	1.0	78 47/64	2 9/16	3/64	0
<b>CATANBO</b>										
CATANB001	Catanbo	Meccanica	M	594	48	0.5	23 25/64	1 57/64	1/64	8
<b>CODIMAG</b>										
CODIMAG01	Codimag	Viva	E	352	34	5.0	13 55/64	1 11/32	13/64	9
CODIMAG02	Codimag	Viva 340	E	362	34	5.0	14 1/4	1 11/32	13/64	9
<b>CRABTREE</b>										
CRABTREE07	Crabtree	45	P	1220	152	5.0	48 1/32	6	13/64	13
CRABTREE10	Crabtree	1200	M	1345	43	0.5	52 61/64	1 11/16	1/64	15
<b>DIDDIE</b>										
DIDDIE04	Diddie	Glazer 860	P	495	35	2.0	19 31/64	1 3/8	5/64	7
DIDDIE08	Diddie	VIP	M	532	55	0.5	20 15/16	2 11/64	1/64	0
DIDDIE03	Diddie	VIP	P	571	35	1.0	22 31/64	1 3/8	3/64	8
<b>DOMINANT</b>										
DOMINANT01	Dominant	414	E	300	26	3.0	11 13/16	1 1/32	1/8	8
DOMINANT02	Dominant	514/515/516/525/526B	E	542	24	3.0	21 11/32	15/16	1/8	14
DOMINANT03	Dominant	313/314	E	544	30	3.0	21 27/64	1 3/16	1/8	14
DOMINANT14	Dominant	527	M	547	40	0.5	21 17/32	1 37/64	1/64	6
DOMINANT09	Dominant	516-526/547-P	E	557	25	3.0	21 59/64	63/64	1/8	14
DOMINANT06	Dominant	714/724/715/725/745	E	666	30	3.0	26 7/32	1 3/16	1/8	17
DOMINANT07	Dominant	747	M	666	40	0.5	26 7/32	1 37/64	1/64	7
DOMINANT17	Dominant		P	670	30	3.0	26 3/8	1 3/16	1/8	0
DOMINANT16	Dominant		P	780	40	3.0	30 45/64	1 37/64	1/8	19
DOMINANT12	Dominant	826	E	800	35	2.0	31 1/2	1 3/8	5/64	20
<b>FUJI</b>										
FUJI01	Fuji	50 (Tip to H/C = 38mm) - Rigid	M	550	48	2.0	21 21/32	1 57/64	5/64	8
FUJI04	Fuji	52 New Shinohara - Rigid	M	550	42	2.0	21 21/32	1 21/32	5/64	7
FUJI10	Fuji	52 New Shinohara - Flexi	M	550	42	0.5	21 21/32	1 21/32	1/64	9
FUJI05	Fuji	52 Special - Rigid	M	570	35	2.0	22 7/16	1 3/8	5/64	8
FUJI06	Fuji	52 Standard - Rigid	M	580	42	2.0	22 53/64	1 21/32	5/64	8
FUJI02	Fuji	Shinohara 56 New - Rigid	M	610	42	2.0	24 1/64	1 21/32	5/64	10
FUJI09	Fuji	58 - Rigid	M	620	48	2.0	24 13/32	1 57/64	5/64	9
FUJI14	Fuji	S66	M	692	48	0.5	27 1/4	1 57/64	1/64	11

Legend: **M** = Metal with Rubber **P** = Plastic **E** = EPDM Rubber **C** = Combination **T** = Tufnol **B** = Brass **H** = Narrow Profile

FUJI				MM			INCHES			
Part No	Machine	Model	Type	Length	Width	Thk	Length	Width	Thk	No Holes
FUJI07	Fuji	65/66 - Rigid	M	700	48	2.0	27 9/16	1 57/64	5/64	11
FUJI03	Fuji	74 Shinohara (Blanket Washer)	M	780	30	0.5	30 45/64	1 3/16	1/64	10
FUJI08	Fuji	66AW	P	693	30	1.0	27 9/32	1 3/16	3/64	9
FUJI12	Fuji	74 Shinohara - Flexi	M	795	48	0.5	31 19/64	1 57/64	1/64	13
FUJI13	Fuji	74 Shinohara - Rigid	M	795	48	2.0	31 19/64	1 57/64	5/64	13
FUJI19	Fuji	75	P	820	30	1.0	32 9/32	1 3/16	3/64	10
FUJI17	Fuji	75	M	835	48	0.5	32 7/8	1 57/64	1/64	13
FUJI11	Fuji	Shinohara 102 Standard - Rigid	M	1085	48	2.0	42 23/32	1 57/64	5/64	17
FUJI18	Fuji		M	1244	65	0.5	48 31/32	2 9/16	1/64	13
FUJI15	Fuji	MTP - Flexi	M	1252	65	0.5	49 19/64	2 9/16	1/64	13
<b>GALLUS</b>										
GALLUS07	Gallus	R 160	M	222	35	0.5	8 47/64	1 3/8	1/64	5
GALLUS03	Gallus	R 200 (p/n 098173)	M	252	35	0.5	9 59/64	1 3/8	1/64	6
GALLUS02	Gallus	TSC 250	M	292	35	0.5	11 1/2	1 3/8	1/64	0
<b>GIEBLER</b>										
GIEBLER06	Giebler		E	623	25	5.0	24 17/32	63/64	13/64	0
<b>GOEBEL</b>										
GOEBEL02	Goebel	Optiforma MOQ 5 pcs	P	589	40	1.0	23 3/16	1 37/64	3/64	6
GOEBEL04	Goebel	Ecoprint (w/slots) MOQ 5 pcs	M	590	57	0.5	23 15/64	2 1/4	1/64	6
GOEBEL07	Goebel	Optiforma 520 MOQ 5 pcs	P	615	35	1.0	24 7/32	1 3/8	3/64	6
<b>GOSS</b>										
GOSS16	Goss	A24 (4M034100B / WM.9E010415S)	M	1036	50	2.0	40 25/32	1 31/32	5/64	12
GOSS09	Goss	Community - SS C 30								
GOSS05	Goss	Universal	M	1060	65	0.5	41 47/64	2 9/16	1/64	11
<b>HAMILTON</b>										
HAMILTON01	Hamilton		M	1125	52	0.5	44 19/64	2 3/64	1/64	12
<b>HARRIS</b>										
HARRIS05	Harris	1000/M200/M300	M	1044	65	0.5	41 7/64	2 9/16	1/64	11
HARRIS14	Harris	M850	M	1064	60	0.5	41 57/64	2 23/64	1/64	11
HARRIS11	Harris	SUNDAY S2000 (w/slots)	M	1469	50	0.5	57 53/64	1 31/32	1/64	13
HARRIS19	Harris	SUNDAY S4000 (w/holes)	M	1580	60	0.5	62 13/64	2 23/64	1/64	17
<b>HASHIMOTO</b>										
HASHIMOTO02	Hashimoto	AF-S & AF-K	M	539	54	0.5	21 7/32	2 1/8	1/64	6
HASHIMOTO03	Hashimoto	522	M	570	55	0.5	22 7/16	2 11/64	1/64	6
HASHIMOTO01	Hashimoto	652P	M	720	60	0.5	28 11/32	2 23/64	1/64	7
<b>HAMADA</b>										
HAMADA35	Hamada	106-11-31-6	E	321	45	5.0	12 21/32	1 49/64	13/64	9
HAMADA40	Hamada	HSO-700V (old code H04 for 611/612)	E	335	45	5.0	13 3/16	1 49/64	13/64	9
HAMADA21	Hamada	HSO-DU34-2	M	357	34	0.5	14 1/16	1 11/32	1/64	5
HAMADA29	Hamada	VS RS34	M	357	42	0.5	14 1/16	1 21/32	1/64	5
HAMADA18	Hamada	HSO-234-2	M	372	42	0.5	14 41/64	1 21/32	1/64	5
HAMADA17	Hamada	HSO-075	M	482	40	0.5	18 31/32	1 37/64	1/64	13
HAMADA20	Hamada	HSO-75 (old code H05 700 CDX NP)	M	482	49.5	0.5	18 31/32	1 61/64	1/64	13
HAMADA06	Hamada	E47-2 Group II/I106-11-31-6	E	487	45	5.0	19 11/64	1 49/64	13/64	13
HAMADA19	Hamada	HSO-75	M	491	49.5	0.5	19 21/64	1 61/64	1/64	13
HAMADA31	Hamada	HSO-48 (old code H08 C248 ESF)	M	514	46	0.5	20 15/64	1 13/16	1/64	14
HAMADA23	Hamada	HSO-800-2	M	540	49	0.5	21 17/64	1 59/64	1/64	14
HAMADA22	Hamada	ZL-4911-2	M	540	55	0.5	21 17/64	2 11/64	1/64	6
HAMADA24	Hamada	HSO-252C	M	554	40	0.5	21 13/16	1 37/64	1/64	15
HAMADA41	Hamada	Krampus 52/R-209 (old code H12)	E	560	45	5.0	22 3/64	1 49/64	13/64	9
HAMADA25	Hamada	B 452	M	570	40	0.5	22 7/16	1 37/64	1/64	15
HAMADA32	Hamada	PM-066-4912-00	M	570	55	0.5	22 7/16	2 11/64	1/64	6

Legend: **M** = Metal with Rubber **P** = Plastic **E** = EPDM Rubber **C** = Combination **T** = Tufnol **B** = Brass **H** = Narrow Profile

HAMADA				MM			INCHES			
Part No	Machine	Model	Type	Length	Width	Thk	Length	Width	Thk	No Holes
HAMADA26	Hamada	ZK-4911-3	M	610	55	0.5	24	2 11/64	1/64	6
HAMADA27	Hamada	SA-4912	M	620	55	0.5	24 13/32	2 11/64	1/64	7
HAMADA33	Hamada	PM-069-4912-00	M	620	55	0.5	24 13/32	2 11/64	1/64	6
HAMADA14	Hamada	E47-2	M	483	35	0.5	19 1/64	1 3/8	1/64	13
HAMADA07	Hamada	700 CDX Main Head (rubber)	E	484	45	5.0	19 3/64	1 49/64	13/64	13
HAMADA62	Hamada	ALPHA 248	M	518	42	0.5	20 25/64	1 21/32	1/64	14
HAMADA10	Hamada	800 CDX	E	544	45	5.0	21 27/64	1 49/64	13/64	14
HAMADA60	Hamada	ALPHA 66	E	710	51	5.0	27 61/64	2	13/64	11
ITEK										
ITEK01	Itek	975/985/3985	E	355	40	5.0	13 31/32	1 37/64	13/64	6
KBA										
KBA54	KBA	Performa 66	P	710	24	3.0	27 61/64	15/16	1/8	0
KBA02	KBA	SRO	P	770	50	1.0	30 5/16	1 31/32	3/64	8
KBA01	KBA	SRO (old model)	M	770	50	0.5	30 5/16	1 31/32	1/64	8
KBA37	KBA	Rapida 74	P	780	40	1.0	30 45/64	1 37/64	3/64	0
KBA05	KBA	Rapida 72	M	780	46	0.5	30 45/64	1 13/16	1/64	11
KBA19	KBA	Performa 74	P	803	24	2.0	31 39/64	15/16	5/64	0
KBA36	KBA	Performa 74	E	803	24	3.0	31 39/64	29/32	1/8	0
KBA15	KBA	Rapida 75	E	815	24	3.0	32 3/32	15/16	1/8	0
KBA16	KBA	Rapida 75	P	815	24	3.0	32 3/32	15/16	1/8	0
KBA03	KBA	Rapida 104 (narrow)	M	1130	46	0.5	44 31/64	1 13/16	1/64	0
KBA04	KBA	Rapida 104 (wide)	M	1130	51	0.5	44 31/64	2	1/64	0
KBA06	KBA	Rapida 104 (wide)	M	1130	51	0.5	44 31/64	2	1/64	12
KBA18	KBA	Rapida 105	P	1140	45	2.0	44 7/8	1 49/64	5/64	0
KBA10	KBA	Rapida 105	M	1140	46	0.5	44 7/8	1 13/16	1/64	0
KBA07	KBA	Rapida 105	M	1140	55	0.5	44 7/8	2 11/64	1/64	11
KBA12	KBA	Rapida 105	P	1160	35	2.0	45 21/32	1 3/8	5/64	0
KBA17	KBA	Rapida 105	M	1160	46	0.5	45 21/32	1 13/16	1/64	0
KBA38	KBA	Rapida 106	M	1160	38	0.5	45 21/32	1 1/2	1/64	0
KBA20	KBA	Rapida 106	M	1160	43	0.5	45 21/32	1 11/16	1/64	0
KBA13	KBA	Rapida 106	P	1160	43	1.0	45 21/32	1 11/16	3/64	0
KBA11	KBA	Rapida 142 Note: L: 1510 (our standard)	M	1510	65	0.5	59 29/64	2 9/16	1/64	17
KBA55	KBA	Rapida 145 Prensa (P/N P7817891)	M	1540	60	0.5	60 5/8	2 23/64	1/64	0
KBA08	KBA	Rapida 160	M	1540	65	0.5	60 5/8	2 9/16	1/64	19
KBA39	KBA	Metal Star	M	1540	56	0.5	60 5/8	2 13/64	1/64	0
KBA09	KBA	Rapida 162	M	1710	65	0.5	67 21/64	2 9/16	1/64	19
KBA22	KBA	Rapida 164/165	M	1740	56	0.5	68 1/2	2 13/64	1/64	0
KBA WEB										
KBA27	KBA	Compacta 215	M	1092	71	0.5	43	2 51/64	1/64	0
KBA47	KBA	Commander	M	1519	95	0.5	59 51/64	3 47/64	1/64	9
KBA21	KBA	Commander	M	1630	70	0.5	64 11/64	2 3/4	1/64	10
KOMORI										
KOMORI38	Komori	Lithrone 20 Flexi	M	580	48	0.5	22 53/64	1 57/64	1/64	8
KOMORI01	Komori	Lithrone 20 Rigid	M	590	37	2.0	23 15/64	1 29/64	5/64	5
KOMORI07	Komori	Lithrone 26 A/W Narrow	M	700	42	0.5	27 9/16	1 21/32	1/64	10
KOMORI02	Komori	Sprint 710 Flexi	M	710	42	0.5	27 61/64	1 21/32	1/64	6
KOMORI22	Komori	Sprint 710 Rigid	M	710	42	2.0	27 61/64	1 21/32	5/64	6
KOMORI03	Komori	Sprint 715 Flexi	M	715	50	0.5	28 5/32	1 31/32	1/64	6
KOMORI32	Komori	Sprint 715 Rigid	M	715	50	2.0	28 5/32	1 31/32	5/64	6
KOMORI08	Komori	Lithrone 26 A/W (Wide)	M	716	47	0.5	28 3/16	1 27/32	1/64	10
KOMORI04	Komori	Sprint 719 Flexi	M	719	44	0.5	28 5/16	1 47/64	1/64	6

Legend: **M** = Metal with Rubber **P** = Plastic **E** = EPDM Rubber **C** = Combination **T** = Tufnol **B** = Brass **H** = Narrow Profile

KOMORI				MM			INCHES			
Part No	Machine	Model	Type	Length	Width	Thk	Length	Width	Thk	No Holes
KOMORI05	Komori	Lithrone 26 Flexi	M	726	36	0.5	28 37/64	1 27/64	1/64	6
KOMORI06	Komori	Lithrone 26 Rigid [p/n 261-4603-402]	M	726	36	2.0	28 37/64	1 27/64	5/64	6
KOMORI36	Komori	Lithrone 26 Flexi	M	726	50	0.5	28 37/64	1 31/32	1/64	0
KOMORI60	Komori	Lithrone 26 - Lithrone 526	M	726	42	0.5	28 37/64	1 21/32	1/64	6
KOMORI51	Komori	Lithrone LS 26	P	730	35	1.0	28 47/64	1 3/8	3/64	10
KOMORI52	Komori	Lithrone LS 26	M	730	35	0.5	28 47/64	1 3/8	1/64	10
KOMORI12	Komori	Lithrone 28 A/W	P	765	47	5.0	30 1/8	1 27/32	13/64	11
KOMORI11	Komori	Lithrone 28 A/W	M	766	47	0.5	30 5/32	1 27/32	1/64	11
KOMORI42	Komori	Lithrone 28 [p/n 274-4629-401]	M	775	47	0.5	30 33/64	1 27/32	1/64	11
KOMORI75	Komori	Lithrone 28	M	780	42	0.5	30 45/64	1 21/32	1/64	9
KOMORI09	Komori	Lithrone 28 Flexi	M	785	42	0.5	30 29/32	1 21/32	1/64	6
KOMORI10	Komori	Lithrone 28 Rigid	M	785	37	2.0	30 29/32	1 29/64	5/64	6
KOMORI37	Komori	Lithrone 28 Flexi new style	M	785	37	0.5	30 29/32	1 29/64	1/64	6
KOMORI45	Komori	Spica 29	M	805	47	0.5	31 11/16	1 27/32	1/64	11
KOMORI76	Komori	Spica 29	P	805	47	5.0	31 11/16	1 27/32	13/64	11
KOMORI77	Komori	Spica 29 [p/n 345-4500-301]	P	806	38	1.0	31 47/64	1 1/2	3/64	11
KOMORI78	Komori	Lithrone LS29	P	820	35	1.0	32 9/32	1 3/8	3/64	11
KOMORI24	Komori	SX29	E	826	36	5.0	32 33/64	1 27/64	13/64	11
KOMORI107	Komori	L32	P	889	34	1.0	35	1 11/32	3/64	12
KOMORI53	Komori	L32	M	892	43	0.5	35 1/8	1 11/16	1/64	6
KOMORI43	Komori	L32	M	892	47	0.5	35 1/8	1 27/32	1/64	12
KOMORI13	Komori		P	1010	35	1.0	39 49/64	1 3/8	3/64	13
KOMORI44	Komori	L37	P	1016	36	1.0	40	1 27/64	3/64	13
KOMORI90	Komori		M	1035	50	0.5	40 3/4	1 31/32	1/64	12
KOMORI91	Komori	Lithrone LS40SP [p/n 7144600100]	P	1045	50	1.0	41 9/64	1 31/32	3/64	14
KOMORI89	Komori	Lithrone L38S	M	1058	48	0.5	41 5/8	1 57/64	1/64	15
KOMORI61	Komori	Lithrone 40	P	1067	47	5.0	42	1 27/32	13/64	15
KOMORI62	Komori	Lithrone 40	M	1067	47	0.5	42	1 27/32	1/64	15
KOMORI55	Komori	Lithrone 40 A/W	M	1077	42	0.5	42 13/32	1 21/32	1/64	15
KOMORI31	Komori	L40 A/W (Old - 47mm wide)	M	1077	47	0.5	42 13/32	1 27/32	1/64	15
KOMORI103	Komori	Lithrone 40 GL Standard model	P	1085	50	1.0	42 23/32	1 63/64	3/64	15
KOMORI63	Komori	Lithrone 40	M	1090	43	0.5	42 29/32	1 11/16	1/64	15
KOMORI64	Komori	Lithrone 40 (Oval holes)	M	1090	47	0.5	42 29/32	1 27/32	1/64	15
KOMORI28	Komori	Lithrone 40 A/W	P	1094	47	5.0	43 5/64	1 27/32	13/64	8
KOMORI14	Komori	Lithrone 40 Flexi	M	1094	50	0.5	43 5/64	1 63/64	1/64	8
KOMORI15	Komori	Lithrone 40 Rigid	M	1094	50	2.0	43 5/64	1 63/64	5/64	8
KOMORI16	Komori	Lithrone 40 A/W	P	1094	50	5.0	43 5/64	1 31/32	13/64	8
KOMORI29	Komori	Lithrone 40 A/W	P	1094	50	5.0	43 5/64	1 31/32	13/64	15
KOMORI65	Komori	Lithrone 40	M	1098	52	0.5	43 15/64	2 3/64	1/64	15
KOMORI66	Komori	Lithrone 40	P	1098	50	1.0	43 15/64	1 31/32	3/64	15
KOMORI40	Komori	Lithrone GL40	P	1100	35	1.0	43 5/16	1 3/8	3/64	15
KOMORI67	Komori	Lithrone 40	M	1105	50	0.5	43 1/2	1 31/32	1/64	15
KOMORI48	Komori	Lithrone 40	P	1106	50	1.0	43 35/64	1 31/32	3/64	15
KOMORI30	Komori	L40 AW (Old 47mm wide) [p/n 444-4254-064]	M	1110	47	0.5	43 45/64	1 27/32	1/64	15
KOMORI47	Komori	Lithrone S40 (New model)	P	1110	47	1.0	43 45/64	1 27/32	3/64	15
KOMORI68	Komori	L40 AW (Old 47mm wide)	P	1110	47	5.0	43 45/64	1 27/32	13/64	15
KOMORI41	Komori	Lithrone 40 A/W	P	1111	50	1.0	43 47/64	1 31/32	3/64	15
KOMORI104	Komori	Lithrone GLX40	P	1116	50	1.0	43 15/16	1 31/32	3/64	15
KOMORI105	Komori	Lithrone LS44SP	P	1150	50	1.0	45 9/32	1 31/32	3/64	16
KOMORI56	Komori	Lithrone LS44SP (Upper) [p/n 7244601501]	P	1165	50	1.0	45 55/64	1 31/32	3/64	16
KOMORI79	Komori	Lithrone 44	M	1178	47	0.5	46 3/8	1 27/32	1/64	17
KOMORI39	Komori	Lithrone 44	M	1190	50	2.0	46 27/32	1 31/32	5/64	9

Legend: **M** = Metal with Rubber **P** = Plastic **E** = EPDM Rubber **C** = Combination **T** = Tufnol **B** = Brass **H** = Narrow Profile

KOMORI				MM			INCHES			
Part No	Machine	Model	Type	Length	Width	Thk	Length	Width	Thk	No Holes
KOMORI71	Komori	Lithrone 44 SP (p/n 4644047064)	M	1210	47	0.5	47 41/64	1 27/32	1/64	17
KOMORI106	Komori	Lithrone 44 SP	P	1210	50	1.0	47 41/64	1 31/32	3/64	17
KOMORI57	Komori	Lithrone LS44 (Lower) (p/n 7244650801)	P	1230	50	1.0	48 27/64	1 31/32	3/64	17
KOMORI99	Komori	Lithrone 50 (min qty 4 pieces)	M	1380	42	0.5	54 21/64	1 21/32	1/64	19
KOMORI WEB										
KOMORI83	Komori	System 35 (Web 16 pages)	M	960	50	0.5	37 51/64	1 31/32	1/64	13
KOMORI93	Komori	System 38	M	1040	56	0.5	40 15/16	2 3/16	1/64	11
MAN										
MAN01	MAN/Roland	Rotoman 8	M	1038	65	0.5	40 55/64	2 9/16	1/64	10
MAN07	MAN/Roland	Rotoman 70	M	1040	65	0.5	40 15/16	2 9/16	1/64	6
MAN10	MAN/Roland	Lithoman Duplex	M	1156	65	0.5	45 33/64	2 9/16	1/64	6
MAN12	MAN/Roland	Colorman	M	1730	65	0.5	68 7/64	2 9/16	1/64	9
MAN15	MAN/Roland	Rotoman	M	1766	64	0.5	69 17/32	2 33/64	1/64	11
MAN11	MAN/Roland	Lithoman	M	2060	65	0.5	81 3/32	2 9/16	1/64	11
MILLER										
MILLER01	Miller	TP 29/TP 74	M	826	67	0.5	32 33/64	2 41/64	1/64	8
MILLER06	Miller	TP 32	M	920	67	0.5	36 7/32	2 41/64	1/64	9
MILLER02	Miller	TP 36/92/93/94	M	1020	67	0.5	40 5/32	2 41/64	1/64	10
MILLER04	Miller	TP 38	M	1092	76	0.5	43	3	1/64	10
MILLER03	Miller	TP 41/TP 104	M	1140	67	0.5	44 7/8	2 41/64	1/64	12
MITSUBISHI										
MITSUBISHI22	Mitsubishi	1F	P	776	28	3.0	30 35/64	1 7/64	1/8	9
MITSUBISHI19	Mitsubishi	1E/1F	M	778	33	0.5	30 5/8	1 19/64	1/64	9
MITSUBISHI08	Mitsubishi	1E	P	784	40	2.0	30 55/64	1 37/64	5/64	8
MITSUBISHI07	Mitsubishi	1E/1F/1G w/slots (cntr/cntr 104mm)	M	785	40	0.5	30 29/32	1 37/64	1/64	8
MITSUBISHI12	Mitsubishi	1E	M	785	40	0.5	30 29/32	1 37/64	1/64	8
MITSUBISHI14	Mitsubishi	1G	M	785	37	0.5	30 29/32	1 29/64	1/64	8
MITSUBISHI42	Mitsubishi	1E/1F/1G w/holes (cntr/cntr 104mm)	M	785	40	0.5	30 29/32	1 37/64	1/64	8
MITSUBISHI30	Mitsubishi	2F	M	882	40	0.5	34 23/32	1 37/64	1/64	9
MITSUBISHI16	Mitsubishi	3F/Diamond	M	1080	35	0.5	42 33/64	1 3/8	1/64	11
MITSUBISHI02	Mitsubishi	3F	P	1090	45	2.0	42 29/32	1 49/64	5/64	11
MITSUBISHI40	Mitsubishi	3F/G	M	1090	40	0.5	42 29/32	1 37/64	1/64	11
MITSUBISHI06	Mitsubishi	3F/3G/Diamond 3000	M	1095	40	0.5	43 7/64	1 37/64	1/64	11
MITSUBISHI34	Mitsubishi	3F/3G/Diamond 3000	P	1095	40	1.0	43 7/64	1 37/64	3/64	11
MITSUBISHI41	Mitsubishi	3/H/F/Diamond 3000	M	1100	40	0.5	43 5/16	1 37/64	1/64	11
MITSUBISHI29	Mitsubishi	3000	M	1126	40	0.5	44 21/64	1 37/64	1/64	11
MITSUBISHI17	Mitsubishi	3F	M	1186	40	0.5	46 11/16	1 37/64	1/64	11
MITSUBISHI15	Mitsubishi	5F	M	1366	42	0.5	53 25/32	1 21/32	1/64	13
MITSUBISHI44	Mitsubishi	Daya 5ID (MOQ 10pcs)	P	1400	45	2.0	55 1/8	1 49/64	5/64	21
MITSUBISHI20	Mitsubishi	6F/6G	M	1506	40	0.5	59 19/64	1 37/64	1/64	14
MITSUBISHI26	Mitsubishi	Web Press	M	947	60	0.5	37 9/32	2 23/64	1/64	10
MITSUBISHI45	Mitsubishi	Lithopia BT2 Web Press	P	990	55	1.0	39	2 11/64	3/64	11
MITSUBISHI47	Mitsubishi	Lithopia BT2 Web Press	M	990	55	0.5	39	2 11/64	1/64	11
MITSUBISHI46	Mitsubishi	Lithopia Web Press	P	1100	60	1.0	43 5/16	2 23/64	3/64	13
MIYAKOSHI										
MIYAKOSHI20	Miyakoshi	MV-18B-NI	E	525	56	5.0	20 43/64	2 13/64	13/64	12
MIYAKOSHI21	Miyakoshi	MV-DVF-20	E	584	55	5.0	23	2 11/64	13/64	10
MULLER										
MULLER06	Muller Mart.	Pronto 2200 Model 42	M	459	37	0.5	18 5/64	1 29/64	1/64	5
MULLER02	Muller Mart.	O Type/ Concept A/ Progress	M	529	37	0.5	20 53/64	1 29/64	1/64	6
MULLER11	Muller Mart.	Grapha 50	M	530	47	0.5	20 55/64	1 27/32	1/64	6
MULLER18	Muller Mart.		M	559	37	0.5	22 1/64	1 29/64	1/64	6

Legend: **M** = Metal with Rubber **P** = Plastic **E** = EPDM Rubber **C** = Combination **T** = Tufnol **B** = Brass **H** = Narrow Profile



MULLER				MM			INCHES				
Part No	Machine	Model	Type	Length	Width	Thk	Length	Width	Thk	No Holes	
MULLER19	Muller Mart.		M	694	37	0.5	27 21/64	1 29/64	1/64	8	
MULLER15	Muller Mart.	Grapha 40	M	834	37	0.5	32 53/64	1 29/64	1/64	10	
MULLER23	Muller Mart.	VSOP 850 [2722.2627.3]	M	930	37	0.5	36 39/64	1 29/64	1/64	10	
NILPETER											
NILPETER01	Nilpeter	Nilpeter B200	E	240	25	5.0	9 29/64	63/64	13/64	0	
NILPETER02	Nilpeter	Nilpeter B280	E	335	25	5.0	13 3/16	63/64	13/64	0	
OLIVER											
OLIVER01	Oliver	6 & 48	5.0 mm	E	525	50	5.0	20 43/64	1 31/32	13/64	7
OLIVER02	Oliver	52		E	566	50	5.0	22 9/32	1 31/32	13/64	8
OLIVER03	Oliver	58		E	621	50	5.0	24 29/64	1 31/32	13/64	9
OLIVER05	Oliver	66 EZ		E	717	50	5.0	28 15/64	1 31/32	13/64	10
OLIVER04	Oliver	66		E	730	50	5.0	28 47/64	1 31/32	13/64	9
OLIVER06	Oliver	72		E	790	50	5.0	31 7/64	1 31/32	13/64	10
	First determine if you need 3.0 or 5.0mm rubber blades										
OLIVER12	Oliver	52 (original specs)	3.0 mm	E	566	50	3.0	22 9/32	1 31/32	1/8	8
OLIVER13	Oliver	58 (original specs)		E	621	50	3.0	24 29/64	1 31/32	1/8	9
OLIVER15	Oliver	66 EZ (original specs)		E	717	50	3.0	28 15/64	1 31/32	1/8	10
OLIVER14	Oliver	66		E	730	50	3.0	28 47/64	1 31/32	1/8	9
OLIVER19	Oliver	66 SD (original specs - for 43mm width)		E	760	43	3.0	29 59/64	1 11/16	1/8	9
OLIVER20	Oliver	66 SD		M	760	43	0.5	29 59/64	1 11/16	1/64	9
OLIVER24	Oliver	66 SD (original specs - for 50mm width)		E	762	50	3.0	30	1 31/32	1/8	9
OLIVER16	Oliver	72 (original specs)		E	790	50	3.0	31 7/64	1 31/32	1/8	10
OLIVER17	Oliver	82 (original specs)		E	870	50	3.0	34 1/4	1 31/32	1/8	11
OLIVER21	Oliver	75 SD (original specs)		E	880	49	3.0	34 41/64	1 59/64	1/8	11
OLIVER22	Oliver	75 SD (original specs)		M	880	49	0.5	34 41/64	1 59/64	1/64	11
OLIVER18	Oliver	94 (original specs)		E	987	50	3.0	38 55/64	1 31/32	1/8	12
OMEC											
OMEC01	Omec	Omec		M	595	30	0.5	23 27/64	1 3/16	1/64	6
PLANETA											
PLANETA02	Planeta	4E Super Variant - 4-6 - Standard		P	1060	60	5.0	41 47/64	2 23/64	13/64	9
PLANETA01	Planeta	Varimat		M	1150	68	0.5	45 9/32	2 43/64	1/64	13
PLANETA05	Planeta	6 standard (clear, soft plastic)		P	1350	60	5.0	53 9/64	2 23/64	13/64	15
PLANETA04	Planeta	7 (clear, soft plastic)		P	1510	60	5.0	59 29/64	2 23/64	13/64	15
POGO											
POGO1	POGO	2-84-441-P		P	950	80	1.0	37 13/32	3 5/32	3/64	8
ROLAND											
PRAKTIKA51	Roland	Praktika 00		M	557	67	0.5	21 59/64	2 41/64	1/64	6
PRAKTIKA53	Roland	Praktika 01		M	705	67	0.5	27 3/4	2 41/64	1/64	7
ROLAND01	Roland	Formall/Junior Print		M	415	60	0.5	16 11/32	2 23/64	1/64	5+4
ROLAND02	Roland	100		M	705	65	0.5	27 3/4	2 9/16	1/64	7
ROLAND24	Roland	100 (w/slots)		M	726	65	0.5	28 37/64	2 9/16	1/64	9
ROLAND03	Roland	Favorit RF01		M	720	65	0.5	28 11/32	2 9/16	1/64	8
ROLAND04	Roland	200 (Pre No 235)		M	785	65	0.5	30 29/32	2 9/16	1/64	8
ROLAND34	Roland	200		P	790	60	1.0	31 7/64	2 23/64	3/64	8
ROLAND05	Roland	Favorit RFOB/02/200		M	800	65	0.5	31 1/2	2 9/16	1/64	8
ROLAND06	Roland	300		P	816	60	1.0	32 1/8	2 23/64	3/64	8
ROLAND62	Roland	300		M	816	60	0.5	32 1/8	2 23/64	1/64	8
ROLAND35	Roland	500 [80.07V30-A078/AK]		P	818	60	1.0	32 13/64	2 23/64	3/64	8
ROLAND36	Roland	500		P	818	40	1.0	32 13/64	1 37/64	3/64	0
ROLAND07	Roland	Parva RP1		M	900	65	0.5	35 7/16	2 9/16	1/64	9
ROLAND08	Roland	Parva RP/RZP2		M	920	65	0.5	36 7/32	2 9/16	1/64	10

Legend: **M** = Metal with Rubber **P** = Plastic **E** = EPDM Rubber **C** = Combination **T** = Tufnol **B** = Brass **H** = Narrow Profile

ROLAND				MM			INCHES			
Part No	Machine	Model	Type	Length	Width	Thk	Length	Width	Thk	No Holes
ROLAND09	Roland	Parva RP2C	M	995	65	0.5	39 11/64	2 9/16	1/64	10
ROLAND10	Roland	Rekord 3	M	1042	65	0.5	41 1/64	2 9/16	1/64	11
ROLAND11	Roland	Rekord RVK 3B	M	1075	65	0.5	42 21/64	2 9/16	1/64	11
ROLAND12	Roland	Rekord RZK 3B and 604 (lower unit)	M	1100	65	0.5	43 5/16	2 9/16	1/64	11
ROLAND13	Roland	Rekord RWK 3B	M	1132	65	0.5	44 9/16	2 9/16	1/64	12
ROLAND63	Roland	600 (upper)	M	1090	65	0.5	42 29/32	2 9/16	1/64	11
ROLAND64	Roland	600 (lower) same as code: ROLAND12	M	1100	65	0.5	43 5/16	2 9/16	1/64	11
ROLAND14	Roland	700 (old)	M	1091	56	0.5	42 61/64	2 13/64	1/64	13
ROLAND15	Roland	700 (new)	M	1100	56	0.5	43 5/16	2 13/64	1/64	13
ROLAND26	Roland	700 (new model + w/slots)	M	1100	56	0.5	43 5/16	2 13/64	1/64	13
ROLAND25	Roland	700 (007V143930)	P	1102	56	1.0	43 25/64	2 13/64	3/64	13
ROLAND28	Roland	700 (new model + no holes)	M	1105	40	0.5	43 1/2	1 37/64	1/64	0
ROLAND38	Roland	700 (007V172730)	P	1108	40	1.0	43 5/8	1 37/64	3/64	0
ROLAND39	Roland	700 (007V172730) (3mm)	P	1108	40	3.0	43 5/8	1 37/64	1/8	0
ROLAND16	Roland	Ultra 4 (1st)	M	1145	65	0.5	45 5/64	2 9/16	1/64	11
ROLAND17	Roland	Ultra 4 (2nd)	M	1195	65	0.5	47 3/64	2 9/16	1/64	11
ROLAND42	Roland	Ultra 4 (2nd)	M	1195	65	0.5	47 3/64	2 9/16	1/64	0
ROLAND18	Roland	Ultra V	M	1335	65	0.5	52 9/16	2 9/16	1/64	13
ROLAND37	Roland	Ultra V	M	1335	65	0.5	52 9/16	2 9/16	1/64	0
ROLAND19	Roland	Ultra VI	M	1475	65	0.5	58 5/64	2 9/16	1/64	14
ROLAND43	Roland	Ultra VI	M	1475	65	0.5	58 5/64	2 9/16	1/64	0
ROLAND20	Roland	Ultra VII & VIIB	M	1675	65	0.5	65 15/16	2 9/16	1/64	16
ROLAND21	Roland	Ultra VII & VIIB	M	1710	65	0.5	67 21/64	2 9/16	1/64	16
ROLAND22	Roland	800 V/VW w/slots	M	1410	65	0.5	55 33/64	2 9/16	1/64	13
ROLAND23	Roland	800 VI	M	1510	65	0.5	59 29/64	2 9/16	1/64	14
ROLAND29	Roland	900	M	1410	60	0.5	55 33/64	2 23/64	1/64	14
ROLAND65	Roland	900	P	1410	40	1.0	55 33/64	1 37/64	3/64	0
ROLAND68	Roland	900	P	1524	40	1.0	60	1 37/64	3/64	0
ROLAND27	Roland	900 (07V146730)	P	1529	60	1.0	60 13/64	2 23/64	3/64	16
ROLAND31	Roland	900	M	1529	60	0.5	60 13/64	2 23/64	1/64	16
ROTAPRINT										
ROTAPRINT01	Rotaprint	R45K	P	295	28	1.0	11 39/64	1 7/64	3/64	5
ROTAPRINT02	Rotaprint	R35K/R36K/R37K	P	495	28	1.0	19 31/64	1 7/64	3/64	7
ROTAPRINT10	Rotaprint	R38/50NP - ENGLISH	E	510	35	3.0	20 5/64	1 3/8	1/8	18
ROTAPRINT04	Rotaprint	R35KV/R36KV/R37KV	P	538	28	1.0	21 3/16	1 7/64	3/64	7
ROTATEK										
ROTATEK05	Rotatek	MP 150	M	442	58	0.5	17 13/32	2 9/32	1/64	5
ROTATEK01	Rotatek	100/200/RK 200 PLUS	M	539	58	0.5	21 7/32	2 9/32	1/64	6
ROTATEK04	Rotatek	RK PLUS	M	545	60	0.5	21 29/64	2 23/64	1/64	6
ROTATEK02	Rotatek	300/400	M	584	53	0.5	23	2 3/32	1/64	6
ROTATEK03	Rotatek	300/400	M	584	58	0.5	23	2 9/32	1/64	6
RYOBI										
RYOBI22	Ryobi	2700/2800	P	305	40	5.0	12	1 37/64	13/64	6
RYOBI01	Ryobi	2700/2800	E	305	40	5.0	12	1 37/64	13/64	6
RYOBI16	Ryobi	3200 & 3302M (old)	P	354	40	5.0	13 15/16	1 37/64	13/64	6
RYOBI03	Ryobi	3200 PFA	E	354	28	5.0	13 15/16	1 7/64	13/64	6
RYOBI02	Ryobi	3200 & 3302M (old)	E	355	40	5.0	13 31/32	1 37/64	13/64	6
RYOBI14	Ryobi	3302	E	360	40	5.0	14 11/64	1 37/64	13/64	6
RYOBI17	Ryobi	3304H	P	364	40	5.0	14 21/64	1 37/64	13/64	6
RYOBI20	Ryobi	3304H	E	364	40	5.0	14 21/64	1 37/64	13/64	6
RYOBI10	Ryobi	3404-DI	P	392	26	3.0	15 7/16	1 11/32	1/8	7

Legend: **M** = Metal with Rubber **P** = Plastic **E** = EPDM Rubber **C** = Combination **T** = Tufnol **B** = Brass **H** = Narrow Profile

RYOBI				MM			INCHES			
Part No	Machine	Model	Type	Length	Width	Thk	Length	Width	Thk	No Holes
RYOBI04	Ryobi	4502-450-R/MCS	E	453	41	5.0	17 53/64	1 39/64	13/64	6
RYOBI05	Ryobi	480N/500N	E	507	45	5.0	19 61/64	1 49/64	13/64	9
RYOBI06	Ryobi	480K/480D/500K	E	508	45	5.0	20	1 49/64	13/64	11
RYOBI07	Ryobi	500 KNP Numbering Unit	M	510	42	0.5	20 5/64	1 21/32	1/64	11
RYOBI25	Ryobi	520/522/524-NP Numbering Unit	M	545	47	0.5	21 29/64	1 27/32	1/64	6
RYOBI26	Ryobi	510	E	559	30	3.0	22	1 3/16	1/8	9
RYOBI08	Ryobi	512	E	560	28	5.0	22 3/64	1 7/64	13/64	9
RYOBI24	Ryobi	512 (plastic)	P	560	28	5.0	22 3/64	1 7/64	13/64	9
RYOBI09	Ryobi	520/522/525	E	572	25	5.0	22 33/64	31/32	13/64	9
RYOBI19	Ryobi	520/522 (plastic)	P	572	25	5.0	22 33/64	31/32	13/64	9
RYOBI12	Ryobi	530/560	E	602	39	5.0	23 45/64	1 17/32	13/64	13
RYOBI18	Ryobi	640K	E	736	47	5.0	28 31/32	1 27/32	13/64	16
RYOBI31	Ryobi	784EP	P	848	34	5.0	33 25/64	1 11/32	13/64	12
RYOBI13	Ryobi	662 PFH	E	760	40	5.0	29 59/64	1 37/64	13/64	11
RYOBI21	Ryobi	750	P	855	34	5.0	33 21/32	1 11/32	13/64	12
RYOBI27	Ryobi	750	E	855	34	5.0	33 21/32	1 11/32	13/64	12
RYOBI30	Ryobi	920 (same as RYOBI28 only shorter)	E	1002	34	5.0	39 3/8"	1 11/32	13/64	14
RYOBI23	Ryobi	920	P	1006	35	5.0	39 39/64	1 3/8	13/64	14
RYOBI28	Ryobi	920	E	1006	34	5.0	39 39/64	1 11/32	13/64	14
<b>SAKURAI</b>										
SAKURAI	Refer to: OLIVER									
<b>SHINOHARA</b>										
SHINOHARA	Refer to: FUJI									
<b>SOLNA</b>										
SOLNA01	Solna	24 (plastic)	P	695	52	1.0	27 23/64	2 3/64	3/64	9
SOLNA07	Solna	124/224 - 125/225/425	E	700	22	3.0	27 9/16	55/64	1/8	0
SOLNA08	Solna	164/566	E	710	22	3.0	27 61/64	55/64	1/8	0
SOLNA05	Solna	25	E	730	19.5	3.0	28 47/64	49/64	1/8	0
SOLNA02	Solna	25	P	732	19	1.0	28 13/16	3/4	3/64	0
SOLNA13	Solna	Distributor	E	1088	45	3.0	42 53/64	1 49/64	1/8	15
<b>STEVENS</b>										
STEVENS02	Stevens	Stevens	M	578	50	0.5	22 3/4	1 31/32	1/64	6
<b>TAIYO</b>										
TAIYO02	Taiyo	Kikai-TOF-S	E	512	30	5.0	20 5/32	1 3/16	13/64	11
TAIYO04	Taiyo		E	570	30	5.0	22 7/16	1 3/16	13/64	11
<b>TIMSON</b>										
TIMSON02	Timson	T32/40	M	1080	53	0.5	42 33/64	2 3/32	1/64	0
TIMSON04	Timson	T32/47	M	1257	53	0.5	49 31/64	2 3/32	1/64	0
TIMSON05	Timson	T32/47	M	1257	53	2.0	49 31/64	2 3/32	5/64	0
TIMSON03	Timson	C-T32/53	M	1408	53	0.5	55 7/16	2 3/32	1/64	0
<b>WIFAG</b>										
WIFAG04	Wifag		M	1800	45	0.5	70 55/64	1 49/64	1/64	0
<b>WINKLER</b>										
WINKLER01	Winkler	212/214	M	475	46	2.0	18 45/64	1 13/16	5/64	5

# Master Rubber Suckers

*keep it  
running...*

# HEIDELBERG Suckers - Quick reference guide

## Heidelberg Shaped Suckers

COLOR	OUTSIDE	INSIDE	HEIGHT
Grey	27mm 1 1/16"	7mm 9/32"	6mm 15/64"

04.016.071

**RS501** Packing 25pcs/pack

**Heidelberg**

COLOR	OUTSIDE	INSIDE	HEIGHT
Black	15.5mm 39/64"	4mm 5/32"	16.5mm 21/32"

A1.016.327/04

**RS506** Packing 12pcs/pack

**Heidelberg**

COLOR	OUTSIDE	INSIDE	HEIGHT
Black	29mm 1 9/64"	7mm 9/32"	9mm 23/64"

**RS299** Packing 12pcs/pack

**Heidelberg**  
Excellent for thin paper

COLOR	OUTSIDE	INSIDE	HEIGHT
Beige	22mm 7/8"	6mm 15/64"	5mm 13/64"

**RS502** Packing 25pcs/pack

**Heidelberg**

COLOR	OUTSIDE	INSIDE	HEIGHT
Grey	15.5mm 39/64"	5mm 13/64"	31mm 17/32"

**RS507** Packing 12pcs/pack

**Heidelberg**

COLOR	OUTSIDE	INSIDE	HEIGHT
Red	23mm 29/32"	12mm 15/32"	3.5mm 9/64"

F3.582.263/

**RS511** Packing 12pcs/pack

**Heidelberg**

COLOR	OUTSIDE	INSIDE	HEIGHT
Beige	22mm 7/8"	6mm 15/64"	5mm 13/64"

**RS502** Packing 25pcs/pack

**Heidelberg**

COLOR	OUTSIDE	INSIDE	HEIGHT
Black	28mm 1 7/64"	17mm 43/64"	6mm 15/64"

66.028.405

**RS508** Packing 12pcs/pack

**Heidelberg**

COLOR	OUTSIDE	INSIDE	HEIGHT
Clear	31mm 1 7/32"	16mm 5/8"	14mm 35/64"

00.580.6723/02

**RS512** Packing 12pcs/pack

**Heidelberg**

COLOR	OUTSIDE	INSIDE	HEIGHT
Red	19mm 3/4"	7mm 9/32"	3mm 1/8"

42.016.072

**RS503** Packing 25pcs/pack

**Heidelberg**

COLOR	OUTSIDE	INSIDE	HEIGHT
Black	28mm 1 7/64"	17mm 43/64"	6mm 15/64"

66.028.405

**RS508** Packing 12pcs/pack

**Heidelberg**

COLOR	OUTSIDE	INSIDE	HEIGHT
Red	28mm 1 7/64"	16mm 5/8"	3.6mm 9/64"

F6.582.263

**RS513** Packing 12pcs/pack

**Heidelberg**

COLOR	OUTSIDE	INSIDE	HEIGHT
Black	21mm 53/64"	5mm 13/64"	4mm 5/32"

**RS504** Packing 25pcs/pack

**Heidelberg**

COLOR	OUTSIDE	INSIDE	HEIGHT
Black	30.5mm 1 13/64"	5.5mm 7/32"	12mm 15/32"

**RS509** Packing 12pcs/pack

**Heidelberg**  
Excellent for thin paper

**RS520** **RS521**  
**RS522** **RS523**

**RS524**

**Heidelberg**  
Stitchmaster - refer to page 116

Check Page 126  
for flat suckers

## World-wide distribution of rubber suckers for the printing and packaging industry

The Master rubber sucker range has been developed over decades and is now distributed world-wide. Produced to original manufacturers' specifications our rubber suckers cope easily with the demands of to-days high speed printing presses.

### Shaped Suckers – Alphabetically listed

On the following pages you will find, alphabetically listed, shaped suckers for nearly every press in the printing industry. We are continuously adding suckers for new or less known machine models so if you cannot find the rubber sucker you need please enquire. There may be times when the color of the sucker supplied does not match the picture in the leaflet, however the quality and material used will always remain unchanged.

### Flat Suckers – Quick and easy identification system

All flat suckers are color coded according to thickness and the product code incorporates all dimensions as well as the color of the sucker enabling quick and easy identification:

#### Example:

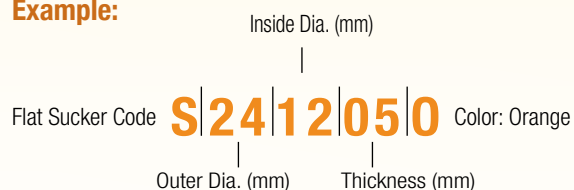

#### Color code:

Our rubber suckers are colored according to thickness

Orange	O	N/R	0.5mm	1/64"
Grey	G	N/R	0.8mm	1/32"
Blue	B	N/R	1.0mm	3/64"
Yellow	Y	N/R	1.5mm	1/16"
Green	N	N/R	2.0mm	5/64"
Red	R	SIL	1.0mm	3/64"
Red	R	SIL	1.5mm	1/16"
Clear	C	PER	various	Heidelberg

#### Material:

N/R = Natural Rubber  
PER = Synthetic Material  
SIL = Silicon

## HEIDELBERG

### Quick reference guide

All flat rubber suckers for Heidelberg press models are kept in their original colors and have special product codes for easy identification:



## HEIDELBERG Flat Rubber Suckers

CODE	MATERIAL	COLOR	OUTSIDE		INSIDE		THICKNESS		PACKING
S381310R	SILICON	Red	38mm	1 1/2"	13mm	1/2"	1mm	3/64"	25 pcs/pack
S381308R	SILICON	Red	38mm	1 1/2"	13mm	1/2"	0.8mm	1/32"	25 pcs/pack
S381305R	SILICON	Red	38mm	1 1/2"	13mm	1/2"	0.5mm	1/64"	25 pcs/pack
S321310R	SILICON	Red	32mm	1 1/4"	13mm	1/2"	1mm	3/64"	25 pcs/pack
S321308R 66.028.406/C	SILICON	Red	32mm	1 1/4"	13mm	1/2"	0.8mm	1/32"	25 pcs/pack
S321305R	SILICON	Red	32mm	1 1/4"	13mm	1/2"	0.5mm	1/64"	25 pcs/pack
S381310C 66.028.404/B	"PER" Synthetic	Clear	38mm	1 1/2"	13mm	1/2"	1mm	3/64"	25 pcs/pack
S321305C	"PER" Synthetic	Clear	32mm	1 1/4"	13mm	1/2"	0.5mm	1/64"	25 pcs/pack
S301315C	"PER" Synthetic	Clear	30mm	1 3/16"	13mm	1/2"	1.5mm	1/16"	25 pcs/pack
S301308C	"PER" Synthetic	Clear	30mm	1 3/16"	13mm	1/2"	0.8mm	1/32"	25 pcs/pack
S241008Y 89.028.401/01	"PER" Synthetic	Yellow	24mm	15/16"	10mm	25/64"	0.8mm	1/32"	25 pcs/pack
S381310G 66.028.402	Natural Rubber	Grey	38mm	1 1/2"	13mm	1/2"	1mm	3/64"	25 pcs/pack
S301308G 66.028.401	Natural Rubber	Grey	30mm	1 3/16"	13mm	1/2"	0.8mm	1/32"	25 pcs/pack
S260620R	Natural Rubber	Red	26mm	1 1/32"	6mm	15/64"	2mm	5/64"	25 pcs/pack
S220516R	Natural Rubber	Red	22mm	7/8"	5mm	13/64"	1.6mm	1/16"	25 pcs/pack
S220320W	Natural Rubber	White	22mm	7/8"	3mm	1/8"	2mm	5/64"	25 pcs/pack

Heidelberg

COLOR	OUTSIDE	INSIDE	HEIGHT
Natural	19mm 3/4"	7mm 9/32"	7mm 9/32"

04.016.071

**RS011** Packing 25pcs/pack

**AB-Dick**

COLOR	OUTSIDE	INSIDE	HEIGHT
Beige	25.4mm 1"	10mm 3/8"	24.5mm 31/32"

**RS045** Packing 12pcs/pack

**ATF Chief**

COLOR	OUTSIDE	INSIDE	HEIGHT
Grey	27mm 1 1/16"	7mm 9/32"	6mm 15/64"

**RS501** Packing 25pcs/pack

**ATF Chief**

COLOR	OUTSIDE	INSIDE	HEIGHT
Blue	16mm 5/8"	9mm 23/64"	21mm 53/64"

**RS012** Packing 12pcs/pack

**AB-Dick**

COLOR	OUTSIDE	INSIDE	HEIGHT
Beige	25.5mm 1"	10mm 3/8"	25mm 63/64"

**RS046** Packing 12pcs/pack

**ATF Chief**

COLOR	OUTSIDE	INSIDE	HEIGHT
Black	28mm 1 7/64"	17mm 43/64"	6mm 15/64"

**RS508** Packing 12pcs/pack

**ATF Chief**

COLOR	OUTSIDE	INSIDE	HEIGHT
Black	16mm 5/8"	8mm 5/16"	20mm 25/32"

**RS021** Packing 12pcs/pack

**Albert**

COLOR	OUTSIDE	INSIDE	HEIGHT
Brown	25.4mm 1"	7mm 9/32"	7.5mm 5/16"

**RS048** Packing 12pcs/pack

**ATF Chief**

COLOR	OUTSIDE	INSIDE	HEIGHT
Beige	31mm 1 7/32"	10mm 3/8"	25mm 63/64"

**RS053** Packing 12pcs/pack

**Aurelia-Omsca-Redaelli**

COLOR	OUTSIDE	INSIDE	HEIGHT
Beige	26mm 1 1/32"	7mm 9/32"	9mm 23/64"

**RS043** Packing 12pcs/pack

**ATF Chief**

COLOR	OUTSIDE	INSIDE	HEIGHT
Beige	36mm 1 27/64"	17mm 43/64"	8mm 5/16"

**RS049** Packing 12pcs/pack

**ATF Chief**

COLOR	OUTSIDE	INSIDE	HEIGHT
Blue	34mm 1 11/32"	6.5mm 1/4"	20mm 25/32"

**RS055** Packing 12pcs/pack

**Aurelia-Omsca-Redaelli**

COLOR	OUTSIDE	INSIDE	HEIGHT
Natural	26mm 1 1/32"	5mm 13/64"	20mm 25/32"

**RS044** Packing 12pcs/pack

**ATF Chief**

COLOR	OUTSIDE	INSIDE	HEIGHT
Beige	30mm 1 3/16"	14mm 35/64"	6mm 15/64"

**RS050** Packing 12pcs/pack

**ATF Chief**

COLOR	OUTSIDE	INSIDE	HEIGHT
Black	28mm 1 7/64"	17mm 43/64"	6mm 15/64"

**RS508** Packing 12pcs/pack

**Aurelia-Omsca-Redaelli**

COLOR	OUTSIDE	INSIDE	HEIGHT
Clear	46mm 1 13/16"	17mm 43/64"	9.5mm 3/8"



**RS061** Packing 12pcs/pack

**Bobst**

COLOR	OUTSIDE	INSIDE	HEIGHT
Natural	16mm 5/8"	2mm 5/64"	13mm 1/2"



**RS091** Packing 12pcs/pack

**Bremer**

COLOR	OUTSIDE	INSIDE	HEIGHT
Beige	27mm 1 1/16"	6.5mm 1/4"	10mm 3/8"



**RS112** Packing 12pcs/pack

**Chief**

COLOR	OUTSIDE	INSIDE	HEIGHT
Clear	41mm 1 39/64"	16mm 5/8"	14mm 35/64"



**RS062** Packing 12pcs/pack

**Bobst**

COLOR	OUTSIDE	INSIDE	HEIGHT
Natural	12mm 15/32"	5mm 13/64"	14mm 35/64"



**RS092** Packing 12pcs/pack

**Bremer**

COLOR	OUTSIDE	INSIDE	HEIGHT
Natural	24mm 15/16"	5mm 13/64"	13mm 1/2"



**RS116** Packing 12pcs/pack

**Colormetal**

COLOR	OUTSIDE	INSIDE	HEIGHT
Clear	18mm 23/32"	6mm 15/64"	11mm 7/16"



**RS4071** Packing 12pcs/pack

**Bonelli**

COLOR	OUTSIDE	INSIDE	HEIGHT
Beige	26mm 1 1/32"	7mm 9/32"	9mm 23/64"



**RS043** Packing 12pcs/pack

**C&P**

COLOR	OUTSIDE	INSIDE	HEIGHT
Natural	46mm 1 13/16"	16mm 5/8"	50mm 1 31/32"



**RS121** Packing 12pcs/pack

**Crabtree**

COLOR	OUTSIDE	INSIDE	HEIGHT
Blue	26mm 1 1/32"	6mm 15/64"	17mm 43/64"



**RS081** Packing 12pcs/pack

**Bourj Modulen**

COLOR	OUTSIDE	INSIDE	HEIGHT
Brown	25.4mm 1"	7mm 9/32"	7.5mm 5/16"



**RS048** Packing 12pcs/pack

**C&P**

COLOR	OUTSIDE	INSIDE	HEIGHT
Blue	63mm 2 31/64"	16mm 5/8"	53mm 2 3/32"



**RS122** Packing 12pcs/pack

**Crabtree**

COLOR	OUTSIDE	INSIDE	HEIGHT
Natural	26mm 1 1/32"	5mm 13/64"	20mm 25/32"



**RS044** Packing 12pcs/pack

**Bremer**

COLOR	OUTSIDE	INSIDE	HEIGHT
Beige	26mm 1 1/32"	6.5mm 1/4"	10.5mm 13/32"



**RS111** Packing 12pcs/pack

**Chief**

COLOR	OUTSIDE	INSIDE	HEIGHT
Beige	26mm 1 1/32"	6.5mm 1/4"	10.5mm 13/32"



**RS111** Packing 12pcs/pack

**Didde Glaser**



COLOR	OUTSIDE	INSIDE	HEIGHT
Beige	27mm 1 1/16"	6.5mm 1/4"	10mm 3/8"

**RS112** Packing 12pcs/pack

**Diddie Glaser**

COLOR	OUTSIDE	INSIDE	HEIGHT
Beige	26mm 1 1/32"	7mm 9/32"	9mm 23/64"

**RS043** Packing 12pcs/pack

**Gestetner**

COLOR	OUTSIDE	INSIDE	HEIGHT
Natural	18mm 23/32"	6mm 15/64"	6mm 15/64"

**RS172** Packing 12pcs/pack

**Hamada**

COLOR	OUTSIDE	INSIDE	HEIGHT
Grey	26mm 1 1/32"	10mm 3/8"	26mm 1 1/32"

**RS131** Packing 12pcs/pack

**Diddie Glaser**

COLOR	OUTSIDE	INSIDE	HEIGHT
RS043	26mm	7mm	9mm
Beige	1 1/32"	9/32"	23/64"
RS111	26mm	6.5mm	10.5mm
Beige	1 1/32"	1/4"	13/32"
RS112	27mm	6.5mm	10.5mm
Beige	1 1/16"	1/4"	13/32"

These 3 suckers for Giant are listed in the "Harris" section

**Giant**

COLOR	OUTSIDE	INSIDE	HEIGHT
Grey	16mm 5/8"	6mm 15/64"	9.5mm 3/8"

**RS173** Packing 12pcs/pack

**Hamada**

COLOR	OUTSIDE	INSIDE	HEIGHT
Clear	20mm 25/32"	6mm 15/64"	10mm 3/8"

**RS151** Packing 12pcs/pack

**Duplo**

COLOR	OUTSIDE	INSIDE	HEIGHT
Beige	25.5mm 1"	10mm 3/8"	25mm 63/64"

**RS046** Packing 12pcs/pack

**Giant**

COLOR	OUTSIDE	INSIDE	HEIGHT
Natural	18mm 23/32"	4mm 5/32"	17mm 43/64"

**RS174** Packing 12pcs/pack

**Hamada**

COLOR	OUTSIDE	INSIDE	HEIGHT
White	20mm 25/32"	3.5mm 9/64"	10mm 3/8"

**RS152** Packing 12pcs/pack

**Duplo**

COLOR	OUTSIDE	INSIDE	HEIGHT
Brown	25.4mm 1"	7mm 9/32"	7.5mm 5/16"

**RS048** Packing 12pcs/pack

**Giant**

COLOR	OUTSIDE	INSIDE	HEIGHT
Black	16.5mm 21/32"	12mm 15/32"	36mm 1 27/64"

**RS175** Packing 12pcs/pack

**Hamada**

COLOR	OUTSIDE	INSIDE	HEIGHT
Clear	25mm 63/64"	15mm 19/32"	6mm 15/64"

**RS161** Packing 12pcs/pack

**Fuji-Shinohara**

COLOR	OUTSIDE	INSIDE	HEIGHT
Beige	20mm 25/32"	9mm 23/64"	6mm 15/64"
			0020.1901

**RS171** Packing 12pcs/pack

**Hamada**

COLOR	OUTSIDE	INSIDE	HEIGHT
Beige	26mm 1 1/32"	7mm 9/32"	9mm 23/64"

**RS043** Packing 12pcs/pack

**Harris**

COLOR	OUTSIDE	INSIDE	HEIGHT
Natural	26mm 1 1/32"	5mm 13/64"	20mm 25/32"

**RS044** Packing 12pcs/pack

**Harris**

COLOR	OUTSIDE	INSIDE	HEIGHT
Beige	32mm 1 1/4"	16mm 5/8"	25mm 63/64"

**RS182** Packing 12pcs/pack

**Harris**

COLOR	OUTSIDE	INSIDE	HEIGHT
White	27mm 1 1/16"	6mm 15/64"	20mm 25/32"

**RS188** Packing 12pcs/pack

**Harris**

COLOR	OUTSIDE	INSIDE	HEIGHT
Blue	34mm 1 11/32"	6.5mm 1/4"	20mm 25/32"

**RS055** Packing 12pcs/pack

**Harris**

COLOR	OUTSIDE	INSIDE	HEIGHT
Beige	35mm 1 3/8"	6mm 15/64"	19mm 3/4"

**RS183** Packing 12pcs/pack

**Harris**

COLOR	OUTSIDE	INSIDE	HEIGHT
Grey	27mm 1 1/16"	7mm 9/32"	6mm 15/64" 04.016.071

**RS501** Packing 25pcs/pack

**Heidelberg**

COLOR	OUTSIDE	INSIDE	HEIGHT
Beige	26mm 1 1/32"	6.5mm 1/4"	10.5mm 13/32"

**RS111** Packing 12pcs/pack

**Harris**

COLOR	OUTSIDE	INSIDE	HEIGHT
Brown	22mm 7/8"	2mm 5/64"	14.5mm 37/64"

**RS185** Packing 12pcs/pack

**Harris**

COLOR	OUTSIDE	INSIDE	HEIGHT
Beige	22mm 7/8"	6mm 15/64"	5mm 13/64"

**RS502** Packing 25pcs/pack

**Heidelberg**

COLOR	OUTSIDE	INSIDE	HEIGHT
Beige	27mm 1 1/16"	6.5mm 1/4"	10mm 3/8"

**RS112** Packing 12pcs/pack

**Harris**

COLOR	OUTSIDE	INSIDE	HEIGHT
Beige	26mm 1 1/32"	6mm 15/64"	10mm 3/8"

**RS186** Packing 12pcs/pack

**Harris**

COLOR	OUTSIDE	INSIDE	HEIGHT
Red	19mm 3/4"	7mm 9/32"	3mm 1/8" 42.016.072

**RS503** Packing 25pcs/pack

**Heidelberg**

COLOR	OUTSIDE	INSIDE	HEIGHT
Black	17mm 43/64"	6mm 15/64"	21mm 53/64"

**RS181** Packing 12pcs/pack

**Harris**

COLOR	OUTSIDE	INSIDE	HEIGHT
Brown	39mm 1 35/64"	5.5mm 7/32"	27mm 1 1/16"

**RS187** Packing 12pcs/pack

**Harris**

COLOR	OUTSIDE	INSIDE	HEIGHT
Black	21mm 53/64"	5mm 13/64"	4mm 5/32"

**RS504** Packing 25pcs/pack

**Heidelberg**

COLOR	OUTSIDE	INSIDE	HEIGHT
Black	16.5mm 21/32"	7mm 9/32"	7mm 9/32"

42.016.073

**RS505** Packing 12pcs/pack

**Heidelberg**

COLOR	OUTSIDE	INSIDE	HEIGHT
Black	29mm 1 9/64"	7mm 9/32"	9mm 23/64"

Excellent for thin paper

**RS299** Packing 12pcs/pack

**Heidelberg**

COLOR	OUTSIDE	INSIDE	HEIGHT
Black	20mm 25/32"	5mm 13/64"	13mm 1/2"

2144-240

**RS520** Packing 12pcs/pack

**Heidelberg Stitchmaster**

COLOR	OUTSIDE	INSIDE	HEIGHT
Black	15.5mm 39/64"	4mm 5/32"	16.5mm 21/32"

A1.016.327/04

**RS506** Packing 12pcs/pack

**Heidelberg**

COLOR	OUTSIDE	INSIDE	HEIGHT
Grey	27mm 1 1/16"	17mm 43/64"	7mm 9/32"

SM52-G2.028.405

**RS510** Packing 12pcs/pack

**Heidelberg**

COLOR	OUTSIDE	INSIDE	HEIGHT
Black	16mm 5/8"	4.5mm 11/64"	13mm 1/2"

2144-241

**RS521** Packing 12pcs/pack

**Heidelberg Stitchmaster**

COLOR	OUTSIDE	INSIDE	HEIGHT
Black	15.5mm 39/64"	5mm 13/64"	31mm 1 7/32"

**RS507** Packing 12pcs/pack

**Heidelberg**

COLOR	OUTSIDE	INSIDE	HEIGHT
Red	23mm 29/32"	12mm 15/32"	3.5mm 9/64"

CD74 F3.582.263/

**RS511** Packing 12pcs/pack

**Heidelberg**

COLOR	OUTSIDE	INSIDE	HEIGHT
Black	16mm 5/8"	5mm 13/64"	13mm 1/2"

2144-242

**RS522** Packing 12pcs/pack

**Heidelberg Stitchmaster**

COLOR	OUTSIDE	INSIDE	HEIGHT
Black	28mm 1 7/64"	17mm 43/64"	6mm 15/64"

66.028.405

**RS508** Packing 12pcs/pack

**Heidelberg**

COLOR	OUTSIDE	INSIDE	HEIGHT
Clear	31mm 1 7/32"	16mm 5/8"	14mm 35/64"

00.580.6723/02

**RS512** Packing 12pcs/pack

**Heidelberg**

COLOR	OUTSIDE	INSIDE	HEIGHT
Black	20mm 25/32"	5mm 13/64"	13mm 1/2"

2144-243

**RS523** Packing 12pcs/pack

**Heidelberg Stitchmaster**

COLOR	OUTSIDE	INSIDE	HEIGHT
Black	30.5mm 1 13/64"	5.5mm 7/32"	12mm 15/32"

Excellent for thin paper

**RS509** Packing 12pcs/pack

**Heidelberg**

COLOR	OUTSIDE	INSIDE	HEIGHT
Red	28mm 1 7/64"	16mm 5/8"	3.6mm 9/64"

XL105/XL106 F6.582.263

**RS513** Packing 12pcs/pack

**Heidelberg**

COLOR	OUTSIDE	INSIDE	HEIGHT
Yellow	13mm 1/2"	3mm 1/8"	15mm 19/32"

**RS524** Packing 12pcs/pack

**Heidelberg Stitchmaster**

COLOR	OUTSIDE	INSIDE	HEIGHT
Blue	15mm 19/32"	7mm 9/32"	8mm 5/16"

**RS191** Packing 12pcs/pack

**Horizon**

COLOR	OUTSIDE	INSIDE	HEIGHT
Black	44mm 1 46/64"	5.5mm 7/32"	15mm 19/32" oval shape

**RS202** Packing 12pcs/pack

**Klockner**

COLOR	OUTSIDE	INSIDE	HEIGHT
Red	13mm 1/2"	3.5mm 9/64"	15mm 19/32"

**RS213** Packing 12pcs/pack

**Kluge**

COLOR	OUTSIDE	INSIDE	HEIGHT
Blue	22mm 7/8"	6mm 15/64"	7.5mm 5/16"

**RS192** Packing 12pcs/pack

**Horizon**

COLOR	OUTSIDE	INSIDE	HEIGHT
Beige	26mm 1 1/32"	7mm 9/32"	9mm 23/64"

**RS043** Packing 12pcs/pack

**Kluge**

COLOR	OUTSIDE	INSIDE	HEIGHT
Red	9.3mm 3/8"	4.5mm 11/64"	15mm 19/32"

**RS214** Packing 12pcs/pack

**Kluge**

COLOR	OUTSIDE	INSIDE	HEIGHT
Clear	21mm 53/64"	6mm 15/64"	8.5mm 21/64"

**RS193** Packing 12pcs/pack

**Horizon**

COLOR	OUTSIDE	INSIDE	HEIGHT
Beige	16mm 5/8"	4.3mm 11/64"	5.2mm 13/64"

**RS101** Packing 12pcs/pack

**Kluge**

COLOR	OUTSIDE	INSIDE	HEIGHT
Blue	9.3mm 3/8"	4.5mm 11/64"	15mm 19/32"

**RS215** Packing 12pcs/pack

**Kluge**

COLOR	OUTSIDE	INSIDE	HEIGHT
Black	15mm 19/32"	7mm 9/32"	12mm 15/32"

**RS196** Packing 12pcs/pack

**Itala**

COLOR	OUTSIDE	INSIDE	HEIGHT
Red	14.8mm 38/64"	4.7mm 3/16"	14.5mm 37/64"

**RS211** Packing 12pcs/pack

**Kluge**

COLOR	OUTSIDE	INSIDE	HEIGHT
Beige	22mm 7/8"	6mm 15/64"	5mm 13/64"

**RS502** Packing 25pcs/pack

**Kluge**

COLOR	OUTSIDE	INSIDE	HEIGHT
Black	36mm 1 27/64"	5.5mm 7/32"	15mm 19/32" oval shape

**RS201** Packing 12pcs/pack

**Klockner**

COLOR	OUTSIDE	INSIDE	HEIGHT
Red	25.5mm 1"	4.7mm 3/16"	16mm 5/8"

**RS212** Packing 12pcs/pack

**Kluge**

COLOR	OUTSIDE	INSIDE	HEIGHT
Black	16mm 5/8"	8mm 5/16"	20mm 25/32"

**RS021** Packing 12pcs/pack

**Kolbus**

COLOR	OUTSIDE	INSIDE	HEIGHT
Orange	21mm 53/64"	6mm 15/64"	15mm 19/32"

**RS403** Packing 12pcs/pack

**Kolbus**

COLOR	OUTSIDE	INSIDE	HEIGHT
Black	18mm 23/32"	5mm 13/64"	29mm 1 9/64"

**RS233** Packing 12pcs/pack

**Kolbus**

COLOR	OUTSIDE	INSIDE	HEIGHT
Natural	26mm 1 1/32"	5mm 13/64"	20mm 25/32"

**RS044** Packing 12pcs/pack

**Macey**

COLOR	OUTSIDE	INSIDE	HEIGHT
Green	25mm 63/64"	6mm 15/64"	14mm 35/64"

**RS405** Packing 12pcs/pack

**Kolbus**

COLOR	OUTSIDE	INSIDE	HEIGHT
Black	28mm 1 7/64"	16mm 5/8"	8mm 5/16"

444-1682-004

**RS291** Packing 12pcs/pack

**Komori**

COLOR	OUTSIDE	INSIDE	HEIGHT
Beige	26mm 1 1/32"	6mm 15/64"	10mm 3/8"

**RS186** Packing 12pcs/pack

**Macey**

COLOR	OUTSIDE	INSIDE	HEIGHT
Black	18mm 23/32"	5mm 13/64"	22mm 7/8"

**RS230** Packing 12pcs/pack

**Kolbus**

COLOR	OUTSIDE	INSIDE	HEIGHT
Black	26mm 1 1/32"	9mm 23/64"	8mm 5/16"

L28/L29/LSX29 294-1612-400

**RS292** Packing 12pcs/pack

**Komori**

COLOR	OUTSIDE	INSIDE	HEIGHT
Beige	25.3mm 1"	6mm 15/64"	9mm 23/64"

**RS241** Packing 12pcs/pack

**Macey**

COLOR	OUTSIDE	INSIDE	HEIGHT
Blue	18mm 23/32"	5mm 13/64"	22mm 7/8"

**RS231** Packing 12pcs/pack

**Kolbus**

COLOR	OUTSIDE	INSIDE	HEIGHT
Black	24mm 15/16"	6mm 15/64"	8mm 5/16"

**RS298** Packing 12pcs/pack

**Komori**

COLOR	OUTSIDE	INSIDE	HEIGHT
Natural	46mm 1 13/16"	16mm 5/8"	50mm 1 31/32"

**RS121** Packing 12pcs/pack

**Maitlander**

COLOR	OUTSIDE	INSIDE	HEIGHT
Clear	11mm 7/16"	3mm 1/8"	16mm 5/8"

**RS232** Packing 12pcs/pack

**Kolbus**

COLOR	OUTSIDE	INSIDE	HEIGHT
Black	29mm 1 9/64"	7mm 9/32"	9mm 23/64"

Excellent for thin paper

L40  
**RS299** Packing 12pcs/pack

**Komori**

COLOR	OUTSIDE	INSIDE	HEIGHT
Blue	63mm 2 31/64"	16mm 5/8"	53mm 2 3/32"

**RS122** Packing 12pcs/pack

**Maitlander**

COLOR	OUTSIDE	INSIDE	HEIGHT
Beige	24mm 15/16"	6mm 15/64"	13mm 1/2"



**RS116** Packing 12pcs/pack

**Major**

COLOR	OUTSIDE	INSIDE	HEIGHT
Clear	18mm 23/32"	6mm 15/64"	11mm 7/16"



**RS4071** Packing 12pcs/pack

**Mc Cain**

COLOR	OUTSIDE	INSIDE	HEIGHT
Beige	31mm 1 7/32"	10mm 3/8"	25mm 63/64"



**RS053** Packing 12pcs/pack

**Miehle**

COLOR	OUTSIDE	INSIDE	HEIGHT
Beige	15.75mm 5/8"	5mm 13/64"	14.5mm 37/64"



**RS246** Packing 12pcs/pack

**Major**

COLOR	OUTSIDE	INSIDE	HEIGHT
Beige	26mm 1 1/32"	7mm 9/32"	9mm 23/64"



**RS043** Packing 12pcs/pack

**Miehle**

COLOR	OUTSIDE	INSIDE	HEIGHT
Natural	16mm 5/8"	2mm 5/64"	13mm 1/2"



**RS091** Packing 12pcs/pack

**Miehle - Dexter**

COLOR	OUTSIDE	INSIDE	HEIGHT
Natural	26mm 1 1/32"	5mm 13/64"	20mm 25/32"



**RS044** Packing 12pcs/pack

**M.A.N.**

COLOR	OUTSIDE	INSIDE	HEIGHT
Natural	26mm 1 1/32"	5mm 13/64"	20mm 25/32"



**RS044** Packing 12pcs/pack

**Miehle**

COLOR	OUTSIDE	INSIDE	HEIGHT
Blue	63mm 2 31/64"	16mm 5/8"	53mm 2 3/32"



**RS122** Packing 12pcs/pack

**Miehle**

COLOR	OUTSIDE	INSIDE	HEIGHT
Natural	16mm 5/8"	2mm 5/64"	13mm 1/2"



**RS091** Packing 12pcs/pack

**Mc Cain**

COLOR	OUTSIDE	INSIDE	HEIGHT
Beige	25.5mm 1"	10mm 3/8"	25mm 63/64"



**RS045** Packing 12pcs/pack

**Miehle**

COLOR	OUTSIDE	INSIDE	HEIGHT
Grey	26mm 1 1/32"	10mm 3/8"	26mm 1 1/32"



**RS131** Packing 12pcs/pack

**Miehle**

COLOR	OUTSIDE	INSIDE	HEIGHT
Black	17.5mm 11/16"	3mm 1/8"	18mm 23/32"



**RS261** Packing 12pcs/pack

**Mc Cain**

COLOR	OUTSIDE	INSIDE	HEIGHT
Beige	25.4mm 1"	10mm 3/8"	24.5mm 31/32"



**RS046** Packing 12pcs/pack

**Miehle - Dexter**

COLOR	OUTSIDE	INSIDE	HEIGHT
Natural	27mm 1 1/16"	10mm 3/8"	23mm 29/32"



**RS271** Packing 12pcs/pack

**Miehle**

COLOR	OUTSIDE	INSIDE	HEIGHT
Yellow	35mm 1 3/8"	10mm 3/8"	27mm 1 1/16" Soft



**RS272** Packing 12pcs/pack

**Miehle**

COLOR	OUTSIDE	INSIDE	HEIGHT
Black	28mm 1 7/64"	17mm 43/64"	6mm 15/64"



**RS508** Packing 12pcs/pack

**Miehle**

COLOR	OUTSIDE	INSIDE	HEIGHT
Black	27mm 1 1/16"	7.5mm 19/64"	8mm 5/16"



**RS301** Packing 12pcs/pack

**Mitsubishi**

COLOR	OUTSIDE	INSIDE	HEIGHT
Beige	35mm 1 3/8"	10mm 3/8"	27mm 1 1/16" Hard



**RS273** Packing 12pcs/pack

**Miehle**

COLOR	OUTSIDE	INSIDE	HEIGHT
Beige	24mm 15/16"	6mm 15/64"	13mm 1/2"



**RS116** Packing 12pcs/pack

**Miller**

COLOR	OUTSIDE	INSIDE	HEIGHT
Red	43mm 1 11/16"	8mm 5/16"	15mm 19/32"



**RS302** Packing 12pcs/pack

**Mitsubishi**

COLOR	OUTSIDE	INSIDE	HEIGHT
Grey	39mm 1 35/64"	16mm 5/8"	49mm 1 59/64"



**RS275** Packing 12pcs/pack

**Miehle**

COLOR	OUTSIDE	INSIDE	HEIGHT
Grey	26mm 1 1/32"	10mm 3/8"	26mm 1 1/32"



**RS131** Packing 12pcs/pack

**Miller**

COLOR	OUTSIDE	INSIDE	HEIGHT
Black	15mm 19/32"	7mm 9/32"	12mm 15/32"



**RS196** Packing 12pcs/pack

**Muller**

COLOR	OUTSIDE	INSIDE	HEIGHT
Grey	26mm 1 1/32"	7mm 9/32"	10mm 3/8"



**RS278** Packing 12pcs/pack

**Miehle**

COLOR	OUTSIDE	INSIDE	HEIGHT
Beige	15.75mm 39/64"	5mm 13/64"	14.5mm 37/64"



**RS246** Packing 12pcs/pack

**Miller**

COLOR	OUTSIDE	INSIDE	HEIGHT
Black	15mm 19/32"	6.5mm 1/4"	8.5mm 21/64"



**RS311** Packing 12pcs/pack

**Muller**

COLOR	OUTSIDE	INSIDE	HEIGHT
Grey	28mm 1 7/64"	7mm 9/32"	10mm 3/18"



**RS279** Packing 12pcs/pack

**Miehle**

COLOR	OUTSIDE	INSIDE	HEIGHT
Black	28mm 1 7/64"	17mm 43/64"	6mm 15/64"



**RS508** Packing 12pcs/pack

**Miller**

COLOR	OUTSIDE	INSIDE	HEIGHT
Orange	12mm 15/32"	6mm 15/64"	8mm 5/16"



**RS401** Packing 12pcs/pack

**Muller Martini**

COLOR	OUTSIDE	INSIDE	HEIGHT
Black	16mm 5/8"	7mm 9/32"	10mm 3/8"



Shore hardness 55

**RS402** Packing 12pcs/pack

Muller Martini

COLOR	OUTSIDE	INSIDE	HEIGHT
Black	21mm 53/64"	6mm 15/64"	15mm 19/32"



**RS404** Packing 12pcs/pack

Muller Martini

COLOR	OUTSIDE	INSIDE	HEIGHT
Orange	18mm 23/32"	6mm 15/64"	11mm 7/16"



Shore hardness 50

**RS4073** Packing 12pcs/pack

Muller Martini

COLOR	OUTSIDE	INSIDE	HEIGHT
Orange	16mm 5/8"	7mm 9/32"	10mm 3/8"



**RS4021** Packing 12pcs/pack

Muller Martini

COLOR	OUTSIDE	INSIDE	HEIGHT
Green	25mm 63/64"	6mm 15/64"	14.5mm 37/64"



**RS405** Packing 12pcs/pack

Muller Martini

COLOR	OUTSIDE	INSIDE	HEIGHT
Black	18mm 23/32"	6mm 15/64"	11mm 7/16"



Shore hardness 55

**RS4074** Packing 12pcs/pack

Muller Martini

COLOR	OUTSIDE	INSIDE	HEIGHT
Orange	21mm 53/64"	6mm 15/64"	15mm 19/32"



**RS403** Packing 12pcs/pack

Muller Martini

COLOR	OUTSIDE	INSIDE	HEIGHT
Black	25mm 63/64"	6mm 15/64"	14.5mm 37/64"



**RS406** Packing 12pcs/pack

Muller Martini

COLOR	OUTSIDE	INSIDE	HEIGHT
Natural	18mm 23/32"	5mm 13/64"	10mm 3/8"



Shore hardness 40

**RS4081** Packing 12pcs/pack

Muller Martini

COLOR	OUTSIDE	INSIDE	HEIGHT
Clear	21mm 53/64"	6mm 15/64"	15mm 19/32"
			20.1926



**RS4031** Packing 12pcs/pack

Muller Martini

COLOR	OUTSIDE	INSIDE	HEIGHT
Clear	18mm 23/32"	6mm 15/64"	11mm 7/16"



Shore hardness 40

**RS4071** Packing 12pcs/pack

Muller Martini

COLOR	OUTSIDE	INSIDE	HEIGHT
Orange	18mm 23/32"	5mm 13/64"	10mm 3/8"



Shore hardness 50

**RS4082** Packing 12pcs/pack

Muller Martini

COLOR	OUTSIDE	INSIDE	HEIGHT
Red	20mm 25/32"	5mm 13/64"	15mm 19/32"

Extra durable



**RS418** Packing 12pcs/pack

Muller Martini

COLOR	OUTSIDE	INSIDE	HEIGHT
Blue	18mm 23/32"	6mm 15/64"	11mm 7/16"



Shore hardness 45

**RS4072** Packing 12pcs/pack

Muller Martini

COLOR	OUTSIDE	INSIDE	HEIGHT
Black	18mm 23/32"	5mm 13/64"	10mm 3/8"



Shore hardness 55

**RS4083** Packing 12pcs/pack

Muller Martini



COLOR	OUTSIDE	INSIDE	HEIGHT
Natural	17mm 43/64"	5mm 13/64"	10mm 3/8"



Shore hardness 40

**RS4091** Packing 12pcs/pack

**Muller Martini**

COLOR	OUTSIDE	INSIDE	HEIGHT
Red	25mm 63/64"	6mm 15/64"	13mm 1/2"



**RS411** Packing 12pcs/pack

**Muller Martini**

COLOR	OUTSIDE	INSIDE	HEIGHT
Black	16mm 5/8"	8mm 5/16"	20mm 25/32"



**RS021** Packing 12pcs/pack

**Nebiolo**

COLOR	OUTSIDE	INSIDE	HEIGHT
Blue	17mm 43/64"	5mm 13/64"	10mm 3/8"



Shore hardness 45

**RS4092** Packing 12pcs/pack

**Muller Martini**

COLOR	OUTSIDE	INSIDE	HEIGHT
Red	14mm 35/64"	6mm 15/64"	13mm 1/2"



**RS412** Packing 12pcs/pack

**Muller Martini**

COLOR	OUTSIDE	INSIDE	HEIGHT
Red	19mm 3/4"	7mm 9/32"	3mm 1/8"



**RS503** Packing 25pcs/pack

**Nebiolo**

COLOR	OUTSIDE	INSIDE	HEIGHT
Orange	17mm 43/64"	5mm 13/64"	10mm 3/8"



Shore hardness 50

**RS4093** Packing 12pcs/pack

**Muller Martini**

COLOR	OUTSIDE	INSIDE	HEIGHT
Red	17mm 43/64"	4.5mm 11/64"	10mm 3/8"



**RS414** Packing 12pcs/pack

**Muller Martini**

COLOR	OUTSIDE	INSIDE	HEIGHT
Black	16.5mm 21/32"	7mm 9/32"	7mm 9/32"



**RS505** Packing 12pcs/pack

**Nebiolo**

COLOR	OUTSIDE	INSIDE	HEIGHT
Black	17mm 43/64"	5mm 13/64"	10mm 3/8"



Shore hardness 55

**RS4094** Packing 12pcs/pack

**Muller Martini**

COLOR	OUTSIDE	INSIDE	HEIGHT
Natural	16mm 5/8"	2mm 5/64"	13mm 1/2"



**RS091** Packing 12pcs/pack

**Multith**

COLOR	OUTSIDE	INSIDE	HEIGHT
Black	18mm 23/32"	6mm 15/64"	9.5mm 3/8"



**RS331** Packing 12pcs/pack

**Neckar**

COLOR	OUTSIDE	INSIDE	HEIGHT
Black	25mm 63/64"	6mm 15/64"	10.5mm 13/32"



**RS410** Packing 12pcs/pack

**Muller Martini**

COLOR	OUTSIDE	INSIDE	HEIGHT
Natural	22mm 7/8"	6mm 15/64"	23mm 29/32"



**RS321** Packing 12pcs/pack

**Multith**

COLOR	OUTSIDE	INSIDE	HEIGHT
Black	15mm 19/32"	2mm 5/64"	12mm 15/32"



**RS341** Packing 12pcs/pack

**Panduro**

COLOR	OUTSIDE	INSIDE	HEIGHT
Blue	18mm 23/32"	3mm 1/8"	13mm 1/2"



**RS342** Packing 12pcs/pack

**Panduro**

COLOR	OUTSIDE	INSIDE	HEIGHT
Beige	25.4mm 1"	10mm 3/8"	24.5mm 31/32"



**RS045** Packing 12pcs/pack

**Roland**

COLOR	OUTSIDE	INSIDE	HEIGHT
Grey	39mm 1 35/64"	16mm 5/8"	49mm 1 59/64"



**RS275** Packing 12pcs/pack

**Roland**

COLOR	OUTSIDE	INSIDE	HEIGHT
Natural	16mm 5/8"	2mm 5/64"	13mm 1/2"



**RS091** Packing 12pcs/pack

**Philipsburg**

COLOR	OUTSIDE	INSIDE	HEIGHT
Beige	27mm 1 1/16"	10mm 3/8"	25mm 63/64"



**RS046** Packing 12pcs/pack

**Roland**

COLOR	OUTSIDE	INSIDE	HEIGHT
Black	28mm 1 7/64"	17mm 43/64"	6mm 15/64"



**RS508** Packing 12pcs/pack

**Roland**

COLOR	OUTSIDE	INSIDE	HEIGHT
Blue	18mm 23/32"	3mm 1/8"	13mm 1/2"



**RS342** Packing 12pcs/pack

**Philipsburg**

COLOR	OUTSIDE	INSIDE	HEIGHT
Beige	31mm 1 7/32"	10mm 3/8"	25mm 63/64"



**RS053** Packing 12pcs/pack

**Roland**

COLOR	OUTSIDE	INSIDE	HEIGHT
Natural	30.5mm 1 13/64"	15.5mm 39/64"	15.5mm 39/64"

Standard 021F013230



**RS601** Packing 12pcs/pack

**Roland**

COLOR	OUTSIDE	INSIDE	HEIGHT
Beige	16mm 5/8"	4.3mm 11/64"	5.2mm 13/64"



**RS101** Packing 12pcs/pack

**Rice**

COLOR	OUTSIDE	INSIDE	HEIGHT
Yellow	35mm 1 3/8"	10mm 3/8"	27mm 1 1/16"

Soft



**RS272** Packing 12pcs/pack

**Roland**

COLOR	OUTSIDE	INSIDE	HEIGHT
Blue	30.5mm 1 13/64"	15.5mm 39/64"	15.5mm 39/64"

Hard 021F013230



**RS602** Packing 12pcs/pack

**Roland**

COLOR	OUTSIDE	INSIDE	HEIGHT
Beige	26mm 1 1/32"	7mm 9/32"	9mm 23/64"



**RS043** Packing 12pcs/pack

**Roland**

COLOR	OUTSIDE	INSIDE	HEIGHT
Beige	35mm 1 3/8"	10mm 3/8"	27mm 1 1/16"

Hard



**RS273** Packing 12pcs/pack

**Roland**

COLOR	OUTSIDE	INSIDE	HEIGHT
Natural	21mm 53/64"	5.8mm 15/64"	19mm 3/4"



**RS351** Packing 12pcs/pack

**Rotaprint**

COLOR	OUTSIDE	INSIDE	HEIGHT
Black	14mm 35/64"	5.8mm 15/64"	19mm 3/4"



**RS352** Packing 12pcs/pack

**Rotaprint**

COLOR	OUTSIDE	INSIDE	HEIGHT
Clear	22.5mm 57/64"	6.2mm 1/4"	20.5mm 51/64"



**RS365** Packing 12pcs/pack

**Ryobi**

COLOR	OUTSIDE	INSIDE	HEIGHT
Black	17mm 43/64"	6mm 15/64"	21mm 53/64"



**RS181** Packing 12pcs/pack

**Sheridan**

COLOR	OUTSIDE	INSIDE	HEIGHT
Beige	16mm 5/8"	4mm 5/32"	4.5mm 11/64"



**RS361** Packing 25pcs/pack

**Ryobi**

COLOR	OUTSIDE	INSIDE	HEIGHT
Clear	19mm 3/4"	6.5mm 1/4"	20mm 25/32"



**RS366** Packing 12pcs/pack

**Ryobi**

COLOR	OUTSIDE	INSIDE	HEIGHT
Natural	17.5mm 11/16"	3mm 1/8"	18mm 23/32"



**RS381** Packing 12pcs/pack

**Sheridan**

COLOR	OUTSIDE	INSIDE	HEIGHT
Blue	18mm 23/32"	3mm 1/8"	4mm 5/32"



**RS362** Packing 25pcs/pack

**Ryobi**

COLOR	OUTSIDE	INSIDE	HEIGHT
Red	28mm 1 7/64"	16mm 5/8"	9mm 23/64"



Now extra durable

**RS371** Packing 12pcs/pack

**Sakurai**

COLOR	OUTSIDE	INSIDE	HEIGHT
Yellow	35mm 1 3/8"	10mm 3/8"	27mm 1 1/16"



Soft

**RS272** Packing 12pcs/pack

**Sigma**

COLOR	OUTSIDE	INSIDE	HEIGHT
Natural	22mm 7/8"	6mm 15/64"	22mm 7/8"



**RS363** Packing 12pcs/pack

**Ryobi**

COLOR	OUTSIDE	INSIDE	HEIGHT
Natural	26mm 1 1/32"	5mm 13/64"	20mm 25/32"



**RS044** Packing 12pcs/pack

**Sheridan**

COLOR	OUTSIDE	INSIDE	HEIGHT
Beige	35mm 1 3/8"	10mm 3/8"	27mm 1 1/16"



Hard

**RS273** Packing 12pcs/pack

**Sigma**

COLOR	OUTSIDE	INSIDE	HEIGHT
Red	19mm 3/4"	6.5mm 1/4"	24mm 15/16"



**RS364** Packing 12pcs/pack

**Ryobi**

COLOR	OUTSIDE	INSIDE	HEIGHT
Natural	16mm 5/8"	2mm 5/64"	13mm 1/2"



**RS091** Packing 12pcs/pack

**Sheridan**

COLOR	OUTSIDE	INSIDE	HEIGHT
Beige	26mm 1 1/32"	7mm 9/32"	9mm 23/64"



**RS043** Packing 12pcs/pack

**Stahl**

COLOR	OUTSIDE	INSIDE	HEIGHT
Beige	26mm 1 1/32"	6.5mm 1/4"	10.5mm 13/32"



**RS111** Packing 12pcs/pack

**Stahl**

COLOR	OUTSIDE	INSIDE	HEIGHT
Black	27mm 1 1/16"	10mm 3/8"	1.5mm 1/16"



**RS393** Packing 12pcs/pack

**Thompson**

COLOR	OUTSIDE	INSIDE	HEIGHT
Natural	26mm 1 1/32"	5mm 13/64"	20mm 25/32"



**RS044** Packing 12pcs/pack

**Wohlemberg**

COLOR	OUTSIDE	INSIDE	HEIGHT
Orange	12mm 15/32"	6mm 15/64"	8mm 5/16"



**RS401** Packing 12pcs/pack

**Stahl**

COLOR	OUTSIDE	INSIDE	HEIGHT
Black	27mm 1 1/16"	3mm 1/8"	1.5mm 1/16"



**RS394** Packing 12pcs/pack

**Thompson**

COLOR	OUTSIDE	INSIDE	HEIGHT
Black	17mm 43/64"	6mm 15/64"	21mm 53/64"



**RS181** Packing 12pcs/pack

**Wohlemberg**

COLOR	OUTSIDE	INSIDE	HEIGHT
Black	16mm 5/8"	6mm 15/64"	11mm 7/16"



**RS386** Packing 12pcs/pack

**Stahl**

COLOR	OUTSIDE	INSIDE	HEIGHT
Natural	22mm 7/8"	6mm 15/64"	23mm 29/32"



**RS321** Packing 12pcs/pack

**Toko**

COLOR	OUTSIDE	INSIDE	HEIGHT
Black	18mm 23/32"	5mm 13/64"	19mm 3/4"



**RS631** Packing 12pcs/pack

**Stahl**

COLOR	OUTSIDE	INSIDE	HEIGHT
RS043	26mm 1 1/32"	7mm 9/32"	9mm 23/64"
Beige	25.4mm 1"	7mm 9/32"	7.5mm 19/64"
RS111	26mm 1 1/32"	6.5mm 1/4"	10.5mm 13/32"
RS112	27mm 1 1/16"	6.5mm 1/4"	10.5mm 13/32"

These 4 suckers for "WEB" are listed in the "Harris" section

**Web - Refer to Harris**

COLOR	OUTSIDE	INSIDE	HEIGHT
Black	20mm 25/32"	2mm 5/64"	6.5mm 1/4"



**RS391** Packing 12pcs/pack

**Thisen & Bontitz**

COLOR	OUTSIDE	INSIDE	HEIGHT
Natural	20mm 25/32"	5mm 13/64"	23mm 29/32"



**RS396** Packing 12pcs/pack

**Winkler**

## BOBST FLAT SUCKERS - IN DURABLE SILICON

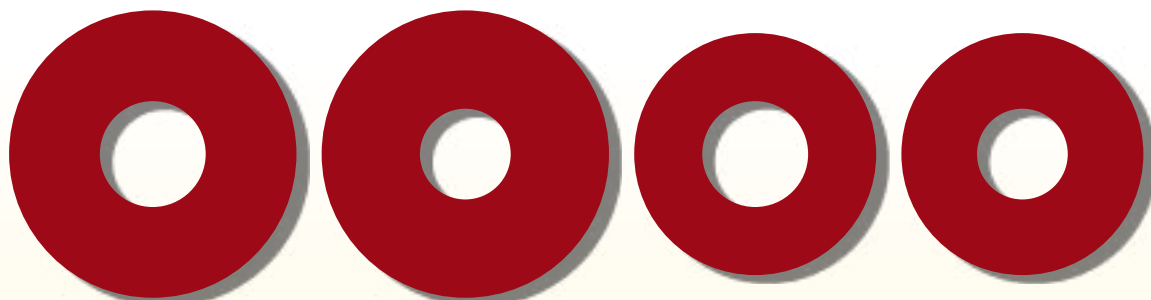

### QUICK REFERENCE GUIDE

S381410R

S381210R

S321410R

S321210R

Bobst			-----MM-----			-----INCHES-----			
CODE	MATERIAL	COLOR	OUTSIDE	INSIDE	THICKNESS	OUTSIDE	INSIDE	THICKNESS	PACKING
S381410R	Silicon	Red	38	14	1.0	1 1/2"	35/64"	3/64"	25 pcs/pack
S381210R	Silicon	Red	38	12	1.0	1 1/2"	15/32"	3/64"	25 pcs/pack
S321410R	Silicon	Red	32	14	1.0	1 1/4"	35/64"	3/64"	25 pcs/pack
S321210R	Silicon	Red	32	12	1.0	1 1/4"	15/32"	3/64"	25 pcs/pack

## KOMORI / RYOBI FLAT SUCKERS IN ORIGINAL COLORS

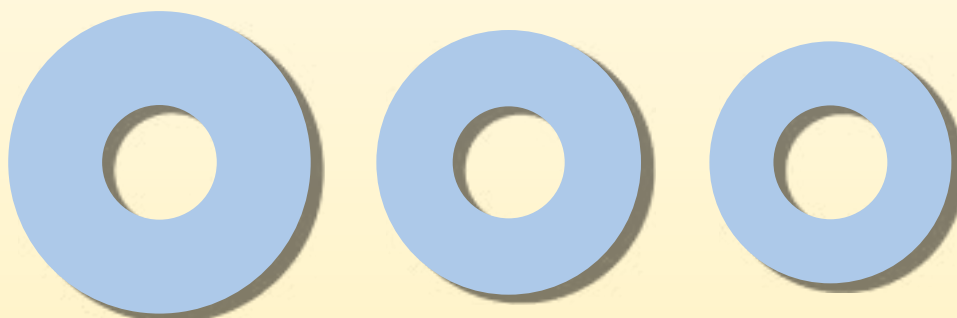

### QUICK REFERENCE GUIDE

SUK40x15x10  
6ZZ-4015-10ISUK35x15x10  
6ZZ-3515-10ISUK32X15X08  
374-1693-400

Komori/Ryobi			-----MM-----			-----INCHES-----			
CODE	MATERIAL	COLOR	OUTSIDE	INSIDE	THICKNESS	OUTSIDE	INSIDE	THICKNESS	PACKING
SUK40X15X10 6ZZ-4015-10I	Natural Rubber	Blue	40	15	1.0	1 37/64"	19/32"	3/64"	25 pcs/pack
SUK40X14X08 6ZZ-4014-081	Natural Rubber	Blue	40	14	0.8	1 37/64"	35/64"	1/32"	25 pcs/pack
SUK40X14X05 6ZZ-4014-051	Natural Rubber	Blue	40	14	0.5	1 37/64"	35/64"	1/64"	25 pcs/pack
SUK38X15X08 444-1680-014	Natural Rubber	Blue	38	15	0.8	1 1/2"	19/32"	1/32"	25 pcs/pack
SUK38X13X08	Natural Rubber	Blue	38	13	0.8	1 1/2"	1/2"	1/32"	25 pcs/pack
SUK35X15X10 6ZZ-3515-10I	Natural Rubber	Blue	35	15	1.0	1 3/8"	19/32"	3/64"	25 pcs/pack
SUK35X15X08 444-1679-014	Natural Rubber	Blue	35	15	0.8	1 3/8"	19/32"	1/32"	25 pcs/pack
SUK35X13X08	Natural Rubber	Blue	35	13	0.8	1 3/8"	1/2"	1/32"	25 pcs/pack
SUK34X14X08 6ZZ-3414-081	Natural Rubber	Blue	34	14	0.8	1 11/32"	35/64"	1/32"	25 pcs/pack
SUK32X15X08 374-1693-400	Natural Rubber	Blue	32	15	0.8	1 1/4"	19/32"	1/32"	25 pcs/pack
SUK32X13X08	Natural Rubber	Blue	32	13	0.8	1 1/4"	1/2"	1/32"	25 pcs/pack
SUK32X12X08 6ZZ-3212-081	Natural Rubber	Blue	32	12	0.8	1 1/4"	15/32"	1/32"	25 pcs/pack
SUK32X11X08 374-1676-400	Natural Rubber	Blue	32	11	0.8	1 1/4"	7/16"	1/32"	25 pcs/pack
SUK30X13X08	Natural Rubber	Blue	30	13	0.8	1 3/16"	1/2"	1/32"	25 pcs/pack

## HEIDELBERG, ROLAND and Sakurai

All flat rubber suckers for press models from these four manufacturers, are kept in their original colors and have special product codes for easy identification:

Heidelberg

Heidelberg

Heidelberg

Heidelberg

Roland

Hamada

Sakurai

### Heidelberg

CODE	MATERIAL	COLOR	-----MM-----			-----INCHES-----			PACKING
			OUTSIDE	INSIDE	THICKNESS	OUTSIDE	INSIDE	THICKNESS	
S381310R	SILICON	Red	38	13	1.0	1 1/2"	1/2"	3/64"	25 pcs/pack
S381308R	SILICON	Red	38	13	0.8	1 1/2"	1/2"	1/32"	25 pcs/pack
S381305R	SILICON	Red	38	13	0.5	1 1/2"	1/2"	1/64"	25 pcs/pack
S321310R	SILICON	Red	32	13	1.0	1 1/4"	1/2"	3/64"	25 pcs/pack
S321308R 66.028.406/C	SILICON	Red	32	13	0.8	1 1/4"	1/2"	1/32"	25 pcs/pack
S321305R	SILICON	Red	32	13	0.5	1 1/4"	1/2"	1/64"	25 pcs/pack
S381310C 66.028.404/B	"PER" Synthetic	Clear	38	13	1.0	1 1/2"	1/2"	3/64"	25 pcs/pack
S321305C	"PER" Synthetic	Clear	32	13	0.5	1 1/4"	1/2"	1/64"	25 pcs/pack
S301315C	"PER" Synthetic	Clear	30	13	1.5	1 3/16"	1/2"	1/16"	25 pcs/pack
S301308C	"PER" Synthetic	Clear	30	13	0.8	1 3/16"	1/2"	1/32"	25 pcs/pack
S241008Y 89.028.401/01	"PER" Synthetic	Yellow	24	10	0.8	15/16"	25/64"	1/32"	25 pcs/pack
S381310G 66.028.402	Natural Rubber	Grey	38	13	1.0	1 1/2"	1/2"	3/64"	25 pcs/pack
S301308G 66.028.401	Natural Rubber	Grey	30	13	0.8	1 3/16"	1/2"	1/32"	25 pcs/pack
S260620R	Natural Rubber	Red	26	6	2.0	1 1/32"	15/64"	5/64"	25 pcs/pack
S220516R	Natural Rubber	Red	22	5	1.6	7/8"	13/64"	1/16"	25 pcs/pack
S220320W	Natural Rubber	White	22	3	2.0	7/8"	1/8"	5/64"	25 pcs/pack

### Sakurai

S249885R	SILICON	Red	24	9.8	0.85	15/16"	25/64"	1/32"	25 pcs/pack
----------	---------	-----	----	-----	------	--------	--------	-------	-------------

### Roland

S421510B	Natural Rubber	Blue	42	15	1.0	1 21/32"	19/32"	3/64"	25 pcs/pack
S381510B S99Z702195	Natural Rubber	Blue	38	15	1.0	1 1/2"	19/32"	3/64"	25 pcs/pack
S381507B 090R600440	Natural Rubber	Blue	38	15	0.7	1 1/2"	19/32"	1/32"	25 pcs/pack
S351510B 090R600340	Natural Rubber	Blue	35	15	1.0	1 3/8"	19/32"	3/64"	25 pcs/pack
S351507B	Natural Rubber	Blue	35	15	0.7	1 3/8"	19/32"	1/32"	25 pcs/pack
S351505B	Natural Rubber	Blue	35	15	0.5	1 3/8"	19/32"	1/64"	25 pcs/pack
S321510B 090R600240	Natural Rubber	Blue	32	15	1.0	1 1/4"	19/32"	3/64"	25 pcs/pack
S321507B	Natural Rubber	Blue	32	15	0.7	1 1/4"	19/32"	1/32"	25 pcs/pack

Flat Rubber Suckers

## Flat Suckers – Quick and easy identification system

All flat suckers are color coded according to thickness and the product code incorporates all dimensions as well as the color of the sucker enabling quick and easy identification:

**Example:**

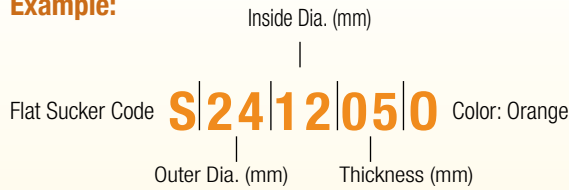

**Color code:**

Our rubber suckers are colored according to thickness

- Orange O N/R 0.5mm 1/64"
- Grey G N/R 0.8mm 1/32"
- Blue B N/R 1.0mm 3/64"
- Yellow Y N/R 1.5mm 1/16"
- Green N N/R 2.0mm 5/64"
- Red R SIL 1.0mm 3/64"
- Red R SIL 1.5mm 1/16"
- Clear C PER various Heidelberg

**Material:**

- N/R = Natural Rubber
- PER = Synthetic Material
- SIL = Silicon

**Packing:** 25pcs/pack

CODE	MATERIAL	COLOR	MM			INCHES		
			OUTSIDE	INSIDE	THICKNESS	OUTSIDE	INSIDE	THICKNESS
S160208G	NR	Grey	16	2	0.8	5/8"	5/64"	1/32"
S170308G	NR	Grey	17	3	0.8	43/64"	1/8"	1/32"
S1902050	NR	Orange	19	2	0.5	3/4"	5/64"	1/64"
S190208G	NR	Grey	19	2	0.8	3/4"	5/64"	1/32"
S1903050	NR	Orange	19	3	0.5	3/4"	1/8"	1/64"
S190308G	NR	Grey	19	3	0.8	3/4"	1/8"	1/32"
S190310B	NR	Blue	19	3	1.0	3/4"	1/8"	3/64"
S190608G	NR	Grey	19	6	0.8	3/4"	15/64"	1/32"
S190610B	NR	Blue	19	6	1.0	3/4"	15/64"	3/64"
S1907050	NR	Orange	19	7	0.5	3/4"	9/32"	1/64"
S190708G	NR	Grey	19	7	0.8	3/4"	9/32"	1/32"
S190710B	NR	Blue	19	7	1.0	3/4"	9/32"	3/64"
S200508G	NR	Grey	20	5	0.8	25/32"	13/64"	1/32"
S210808G	NR	Grey	21	8	0.8	53/64"	5/16"	1/32"
S220320W	NR	White	22	3	2.0	7/8"	1/8"	5/64"
S2205050	NR	Orange	22	5	0.5	7/8"	13/64"	1/64"
S220510B	NR	Blue	22	5	1.0	7/8"	13/64"	3/64"
S220516R	SIL	Red	22	5	1.6	7/8"	13/64"	1/16"
S220608G	NR	Grey	22	6	0.8	7/8"	15/64"	1/32"
S220610B	NR	Blue	22	6	1.0	7/8"	15/64"	3/64"
S220908G	NR	Grey	22	9	0.8	7/8"	23/64"	1/32"
S220920N	NR	Green	22	9	2.0	7/8"	23/64"	5/64"
S220910R	SIL	Red	22	9	1.0	7/8"	23/64"	3/64"
S2405050	NR	Orange	24	5	0.5	15/16"	13/64"	1/64"
S240508G	NR	Grey	24	5	0.8	15/16"	13/64"	1/32"
S240510B	NR	Blue	24	5	1.0	15/16"	13/64"	3/64"
S240515Y	NR	Yellow	24	5	1.5	15/16"	13/64"	1/16"
S240610B	NR	Blue	24	6	1.0	15/16"	15/64"	3/64"
S240610R	SIL	Red	24	6	1.0	15/16"	15/64"	3/64"
S240615R	SIL	Red	24	6	1.5	15/16"	15/64"	1/16"
S2409050	NR	Orange	24	9	0.5	15/16"	23/64"	1/64"
S240908G	NR	Grey	24	9	0.8	15/16"	23/64"	1/32"
S240910R	SIL	Red	24	9	1.0	15/16"	23/64"	3/64"
S241208G	NR	Grey	24	12	0.8	15/16"	15/32"	1/32"
S241210R	SIL	Red	24	12	1.0	15/16"	15/32"	3/64"
S2505050	NR	Orange	25	5	0.5	63/64"	13/64"	1/64"
S250510B	NR	Blue	25	5	1.0	63/64"	13/64"	3/64"
S250605C	Per	Clear	25	6	0.5	63/64"	15/64"	1/64"
S2506050	NR	Orange	25	6	0.5	63/64"	15/64"	1/64"

CODE	MATERIAL	COLOR	MM			INCHES		
			OUTSIDE	INSIDE	THICKNESS	OUTSIDE	INSIDE	THICKNESS
S250608G	NR	Grey	25	6	0.8	63/64"	15/64"	1/32"
S250608R	SIL	Red	25	6	0.8	63/64"	15/64"	1/32"
S250610B	NR	Blue	25	6	1.0	63/64"	15/64"	3/64"
S250620N	NR	Green	25	6	2.0	63/64"	15/64"	5/64"
S250610R	SIL	Red	25	6	1.0	63/64"	15/64"	3/64"
S2509050	NR	Orange	25	9	0.5	63/64"	23/64"	1/64"
S250905C	Per	Clear	25	9	0.5	63/64"	23/64"	1/64"
S250908G	NR	Grey	25	9	0.8	63/64"	23/64"	1/32"
S250910B	NR	Blue	25	9	1.0	63/64"	23/64"	3/64"
S250910R	SIL	Red	25	9	1.0	63/64"	23/64"	3/64"
S251005R	SIL	Red	25	10	0.5	63/64"	25/64"	1/64"
S260620R	SIL	Red	26	6	2.0	1 1/32"	15/64"	5/64"
S2706050	NR	Orange	27	6	0.5	1 1/16"	15/64"	1/64"
S270610B	NR	Blue	27	6	1.0	1 1/16"	15/64"	3/64"
S2709050	NR	Orange	27	9	0.5	1 1/16"	23/64"	1/64"
S270910B	NR	Blue	27	9	1.0	1 1/16"	23/64"	3/64"
S270915Y	NR	Yellow	27	9	1.5	1 1/16"	23/64"	1/16"
S271205R	SIL	Red	27	12	0.5	1 1/16"	15/32"	1/64"
S2806050	NR	Orange	28	6	0.5	1 7/64"	15/64"	1/64"
S280608G	NR	Grey	28	6	0.8	1 7/64"	15/64"	1/32"
S280610B	NR	Blue	28	6	1.0	1 7/64"	15/64"	3/64"
S2809050	NR	Orange	28	9	0.5	1 7/64"	23/64"	1/64"
S2812050	NR	Orange	28	12	0.5	1 7/64"	15/32"	1/64"
S281208G	NR	Grey	28	12	0.8	1 7/64"	15/32"	1/32"
S281210B	NR	Blue	28	12	1.0	1 7/64"	15/32"	3/64"
S281210R	SIL	Red	28	12	1.0	1 7/64"	15/32"	3/64"
S281215R	SIL	Red	28	12	1.5	1 7/64"	15/32"	1/16"
S290915R	SIL	Red	29	9	1.5	1 9/64"	23/64"	1/16"
S2912050	NR	Orange	29	12	0.5	1 9/64"	15/32"	1/64"
S291208G	NR	Grey	29	12	0.8	1 9/64"	15/32"	1/32"
S300510B	NR	Blue	30	5	1.0	1 3/16"	13/64"	3/64"
S300510R	SIL	Red	30	5	1.0	1 3/16"	13/64"	3/64"
S3009050	NR	Orange	30	9	0.5	1 3/16"	23/64"	1/64"
S300908G	NR	Grey	30	9	0.8	1 3/16"	23/64"	1/32"
S300910B	NR	Blue	30	9	1.0	1 3/16"	23/64"	3/64"
S300915Y	NR	Yellow	30	9	1.5	1 3/16"	23/64"	1/16"
S300910R	SIL	Red	30	9	1.0	1 3/16"	23/64"	3/64"
S3011050	NR	Orange	30	11	0.5	1 3/16"	7/16"	1/64"
S301110R	SIL	Red	30	11	1.0	1 3/16"	7/16"	3/64"
S3012050	NR	Orange	30	12	0.5	1 3/16"	15/32"	1/64"
S301208G	NR	Grey	30	12	0.8	1 3/16"	15/32"	1/32"

Material:  
 N/R = Natural Rubber  
 PER = Synthetic Material  
 SIL = Silicon

Color code:  
 Our rubber suckers are colored according to thickness  
 Orange O 0.5mm 1/64" Green N 2.0mm 5/64"  
 Grey G 0.8mm 1/32" Red R 1.0mm 3/64"  
 Blue B 1.0mm 3/64" Red R 1.5mm 1/16"  
 Yellow Y 1.5mm 1/16"

An example:



CODE	MATERIAL	COLOR	MM			INCHES		
			OUTSIDE	INSIDE	THICKNESS	OUTSIDE	INSIDE	THICKNESS
S301210B	NR	Blue	30	12	1.0	1 3/16"	15/32"	3/64"
S301215Y	NR	Yellow	30	12	1.5	1 3/16"	15/32"	1/16"
S301305O	NR	Orange	30	13	0.5	1 3/16"	1/2"	1/64"
S301308G	NR	Grey	30	13	0.8	1 3/16"	1/2"	1/32"
S301310B	NR	Blue	30	13	1.0	1 3/16"	1/2"	3/64"
S301315C	PER	Clear	30	13	1.5	1 3/16"	1/2"	1/16"
S301315Y	NR	Yellow	30	13	1.5	1 3/16"	1/2"	1/16"
S301310R	SIL	Red	30	13	1.0	1 3/16"	1/2"	3/64"
S301405O	NR	Orange	30	14	0.5	1 3/16"	35/64"	1/64"
S301408G	NR	Grey	30	14	0.8	1 3/16"	35/64"	1/32"
S301410B	NR	Blue	30	14	1.0	1 3/16"	35/64"	3/64"
S301415Y	NR	Yellow	30	14	1.5	1 3/16"	35/64"	1/16"
S301420N	NR	Green	30	14	2.0	1 3/16"	35/64"	5/64"
S301410R	SIL	Red	30	14	1.0	1 3/16"	35/64"	3/64"
S301415R	SIL	Red	30	14	1.5	1 3/16"	35/64"	1/16"
S320508G	NR	Grey	32	5	0.8	1 1/4"	13/64"	1/32"
S320520N	NR	Green	32	5	2.0	1 1/4"	13/64"	5/64"
S320608G	NR	Grey	32	6	0.8	1 1/4"	15/64"	1/32"
S320610B	NR	Blue	32	6	1.0	1 1/4"	15/64"	3/64"
S321007B	NR	Blue	32	10	0.7	1 1/4"	25/64"	1/32"
S321108G	NR	Grey	32	11	0.8	1 1/4"	7/16"	1/32"
S321110B	NR	Blue	32	11	1.0	1 1/4"	7/16"	3/64"
S321115Y	NR	Yellow	32	11	1.5	1 1/4"	7/16"	1/16"
S321110R	SIL	Red	32	11	1.0	1 1/4"	7/16"	3/64"
S321208G	NR	Grey	32	12	0.8	1 1/4"	15/32"	1/32"
S321208R	SIL	Red	32	12	0.8	1 1/4"	15/32"	1/32"
S321210B	NR	Blue	32	12	1.0	1 1/4"	15/32"	3/64"
S321210R	SIL	Red	32	12	1.0	1 1/4"	15/32"	3/64"
S321305O	NR	Orange	32	13	0.5	1 1/4"	1/2"	1/64"
S321308C	PER	Clear	32	13	0.8	1 1/4"	1/2"	1/32"
S321308G	NR	Grey	32	13	0.8	1 1/4"	1/2"	1/32"
S321310B	NR	Blue	32	13	1.0	1 1/4"	1/2"	3/64"
S321315Y	NR	Yellow	32	13	1.5	1 1/4"	1/2"	1/16"
S321310R	SIL	Red	32	13	1.0	1 1/4"	1/2"	3/64"
S321315R	SIL	Red	32	13	1.5	1 1/4"	1/2"	1/16"
S321408G	NR	Grey	32	14	0.8	1 1/4"	35/64"	1/32"
S321505O	NR	Orange	32	15	0.5	1 1/4"	19/32"	1/64"
S321508G	NR	Grey	32	15	0.8	1 1/4"	19/32"	1/32"
S321510B	NR	Blue	32	15	1.0	1 1/4"	19/32"	3/64"
S321510R	SIL	Red	32	15	1.0	1 1/4"	19/32"	3/64"
S331508G	NR	Grey	33	15	0.8	1 19/64"	19/32"	1/32"
S331515Y	NR	Yellow	33	15	1.5	1 19/64"	19/32"	1/16"
S331510R	SIL	Red	33	15	1.0	1 19/64"	19/32"	3/64"
S350605O	NR	Orange	35	6	0.5	1 3/8"	15/64"	1/64"
S350608G	NR	Grey	35	6	0.8	1 3/8"	15/64"	1/32"
S350610B	NR	Blue	35	6	1.0	1 3/8"	15/64"	3/64"
S350610R	SIL	Red	35	6	1.0	1 3/8"	15/64"	3/64"
S351008G	NR	Grey	35	10	0.8	1 3/8"	25/64"	1/32"
S351210B	NR	Blue	35	12	1.0	1 3/8"	15/32"	3/64"
S351210R	SIL	Red	35	12	1.0	1 3/8"	15/32"	3/64"
S351215R	SIL	Red	35	12	1.5	1 3/8"	15/32"	1/16"
S351310B	NR	Blue	35	13	1.0	1 3/8"	1/2"	3/64"
S351408G	NR	Grey	35	14	0.8	1 3/8"	35/64"	1/32"
S351505O	NR	Orange	35	15	0.5	1 3/8"	19/32"	1/64"

CODE	MATERIAL	COLOR	MM			INCHES		
			OUTSIDE	INSIDE	THICKNESS	OUTSIDE	INSIDE	THICKNESS
S351508G	NR	Grey	35	15	0.8	1 3/8"	19/32"	1/32"
S351510B	NR	Blue	35	15	1.0	1 3/8"	19/32"	3/64"
S351515Y	NR	Yellow	35	15	1.5	1 3/8"	19/32"	1/16"
S351510R	SIL	Red	35	15	1.0	1 3/8"	19/32"	3/64"
S361505O	NR	Orange	36	15	0.5	1 27/64"	19/32"	1/64"
S361510R	SIL	Red	36	15	1.0	1 27/64"	19/32"	3/64"
S380515Y	NR	Yellow	38	5	1.5	1 1/2"	13/64"	1/16"
S380515R	SIL	Red	38	5	1.5	1 1/2"	13/64"	1/16"
S380910R	SIL	Red	38	9	1.0	1 1/2"	23/64"	3/64"
S381105O	NR	Orange	38	11	0.5	1 1/2"	7/16"	1/64"
S381108G	NR	Grey	38	11	0.8	1 1/2"	7/16"	1/32"
S381110B	NR	Blue	38	11	1.0	1 1/2"	7/16"	3/64"
S381110R	SIL	Red	38	11	1.0	1 1/2"	7/16"	3/64"
S381205O	NR	Orange	38	12	0.5	1 1/2"	15/32"	1/64"
S381208G	NR	Grey	38	12	0.8	1 1/2"	15/32"	1/32"
S381210B	NR	Blue	38	12	1.0	1 1/2"	15/32"	3/64"
S381210R	SIL	Red	38	12	1.0	1 1/2"	15/32"	3/64"
S381305O	NR	Orange	38	13	0.5	1 1/2"	1/2"	1/64"
S381308G	NR	Grey	38	13	0.8	1 1/2"	1/2"	1/32"
S381310B	NR	Blue	38	13	1.0	1 1/2"	1/2"	3/64"
S381315Y	NR	Yellow	38	13	1.5	1 1/2"	1/2"	1/16"
S381310R	SIL	Red	38	13	1.0	1 1/2"	1/2"	3/64"
S381405O	NR	Orange	38	14	0.5	1 1/2"	35/64"	1/64"
S381408G	NR	Grey	38	14	0.8	1 1/2"	35/64"	1/32"
S381410B	NR	Blue	38	14	1.0	1 1/2"	35/64"	3/64"
S381410R	SIL	Red	38	14	1.0	1 1/2"	35/64"	3/64"
S381505O	NR	Orange	38	15	0.5	1 1/2"	19/32"	1/64"
S381508G	NR	Grey	38	15	0.8	1 1/2"	19/32"	1/32"
S381510B	NR	Blue	38	15	1.0	1 1/2"	19/32"	3/64"
S381515Y	NR	Yellow	38	15	1.5	1 1/2"	19/32"	1/16"
S381510R	SIL	Red	38	15	1.0	1 1/2"	19/32"	3/64"
S381515R	SIL	Red	38	15	1.5	1 1/2"	19/32"	1/16"
S391508G	NR	Grey	39	15	0.8	1 17/32"	19/32"	1/32"
S391510B	NR	Blue	39	15	1.0	1 17/32"	19/32"	3/64"
S400910B	NR	Blue	40	9	1.0	1 37/64"	23/64"	3/64"
S400910R	SIL	Red	40	9	1.0	1 37/64"	23/64"	3/64"
S400915R	SIL	Red	40	9	1.5	1 37/64"	23/64"	1/16"
S410908G	NR	Grey	41	9	0.8	1 39/64"	23/64"	1/32"
S410920N	NR	Green	41	9	2.0	1 39/64"	23/64"	5/64"
S411205O	NR	Orange	41	12	0.5	1 39/64"	15/32"	1/64"
S411210B	NR	Blue	41	12	1.0	1 39/64"	15/32"	3/64"
S411405O	NR	Orange	41	14	0.5	1 39/64"	35/64"	1/64"
S411408G	NR	Grey	41	14	0.8	1 39/64"	35/64"	1/32"
S411410B	NR	Blue	41	14	1.0	1 39/64"	35/64"	3/64"
S411415Y	NR	Yellow	41	14	1.5	1 39/64"	35/64"	1/16"
S411410R	SIL	Red	41	14	1.0	1 39/64"	35/64"	3/64"
S411415R	SIL	Red	41	14	1.5	1 39/64"	35/64"	1/16"
S411605O	NR	Orange	41	16	0.5	1 39/64"	5/8"	1/64"
S421510B	NR	Blue	42	15	1.0	1 21/32"	19/32"	3/64"
S440815R	SIL	Red	44	8	1.5	1 47/64"	5/16"	1/16"
S451310B	NR	Blue	45	13	1.0	1 49/64"	1/2"	3/64"
S451315Y	NR	Yellow	45	13	1.5	1 49/64"	1/2"	1/16"
S451408G	NR	Grey	45	14	0.8	1 49/64"	35/64"	1/32"
S451410B	NR	Blue	45	14	1.0	1 49/64"	35/64"	3/64"



## Material:

N/R = Natural Rubber  
 PER = Synthetic Material  
 SIL = Silicon

## Color code:

Our rubber suckers are colored according to thickness

Orange	O	0.5mm	1/64"	Green	N	2.0mm	5/64"
Grey	G	0.8mm	1/32"	Red	R	1.0mm	3/64"
Blue	B	1.0mm	3/64"	Red	R	1.5mm	1/16"
Yellow	Y	1.5mm	1/16"				

## An example:

Inside Dia. Color

Flat Sucker Code **S** **24** **12** **05** **0**

Outer Dia. Thickness

CODE	MATERIAL	COLOR	MM			INCHES		
			OUTSIDE	INSIDE	THICKNESS	OUTSIDE	INSIDE	THICKNESS
S451510B	NR	Blue	45	15	1.0	1 49/64"	19/32"	3/64"
S451520N	NR	Green	45	15	2.0	1 49/64"	19/32"	5/64"
S451510R	SIL	Red	45	15	1.0	1 49/64"	19/32"	3/64"
S451515R	SIL	Red	45	15	1.5	1 49/64"	19/32"	1/16"
S451610B	NR	Blue	45	16	1.0	1 49/64"	5/8"	3/64"
S451615Y	NR	Yellow	45	16	1.5	1 49/64"	5/8"	1/16"
S451620N	NR	Green	45	16	2.0	1 49/64"	5/8"	5/64"
S451610R	SIL	Red	45	16	1.0	1 49/64"	5/8"	3/64"
S451708G	NR	Grey	45	17	0.8	1 49/64"	43/64"	1/32"
S451720N	NR	Green	45	17	2.0	1 49/64"	43/64"	5/64"
S500620N	NR	Green	50	6	2.0	1 31/32"	15/64"	5/64"
S500808G	NR	Grey	50	8	0.8	1 31/32"	5/16"	1/32"
S500810B	NR	Blue	50	8	1.0	1 31/32"	5/16"	3/64"
S500815Y	NR	Yellow	50	8	1.5	1 31/32"	5/16"	1/16"
S500820N	NR	Green	50	8	2.0	1 31/32"	5/16"	5/64"
S500810R	SIL	Red	50	8	1.0	1 31/32"	5/16"	3/64"

# LubeClean

## LUBRICATES AND CLEANS!



### Code: LUBECLEAN

LubeClean is an exceptional product that has taken the graphics industry by storm. Formulated to prevent friction burn-up of ink rollers on idle printing units during printing, LubeClean also gently deep cleans and rejuvenates the rollers!

LubeClean cleans off quick and easy at the end of the shift and contrary to other products on the market it has a very pleasant fragrance.

LubeClean does not harm plates or blankets and works with both conventional and UV ink.

#### Instant benefits:

- Lubricates AND deep cleans inking rollers
- Will not harm plates or blankets
- Quick and easy to clean off at the end of shift
- Pleasant fragrance during use
- Works with conventional and UV ink
- Non-caustic
- Non-toxic
- Non-flammable

Packing: 900 gram (2.0 lbs)/can - 12 cans/box

# Master PRODUCTS

Dedication to customer satisfaction and quality products as well as investment in modern production facilities have ensured that Master products are now distributed world-wide.

This rapid expansion rests on a firm foundation of old fashioned business principles:

- Quality products
- Competitive pricing
- Quick delivery
- Innovative product and packaging design

All *Master* products have been thoroughly tested in the international market and are accepted for their high performance and durability.

Any reproduction, in whole or part of this catalogue is strictly prohibited. All rights reserved.



## ROLLER MASTER

A new, highly effective, "easy to apply" roller cleaning paste. Excellent for both UV and standard ink.

This "non-grit" formulation has no impact on plate wear and no harmful effect on rubber or chrome rollers.

Roller Master maintains rollers in perfect "like new" condition.



### Code: RM1

- Removes ink, glaze and calcium from roller surfaces
- High viscosity, "easy to apply" paste
- Contains no abrasives, will not cause plate wear
- Will not harm NBR or EPDM rollers
- Contains no strong solvents
- Stable in a wide range of temperatures
- Zero VOC

Packing: 1 kilo (2.2lbs)/can - 12 cans/box

## Deletion/Addition Pens

A great range of pens made with a special long lasting tip.



Packing: 10 pens per box

Deletion Pens: Removes image quickly and safely on all positive and most negative plates.

Code:	Description:
<b>DPENF</b>	<b>Deletion pen with fine tip</b>
<b>DPENL</b>	<b>Deletion pen with medium/large tip</b>

CTP Deletion Pens: Only for thermal CTP plates and not for use with violet plates.

Code:	Description:
<b>CTDPENF</b>	<b>CTP deletion pen with fine tip</b>
<b>CTDPENL</b>	<b>CTP deletion pen with medium/large tip</b>

Addition Pens: Great touch up pens to fill in pin holes, repair broken solids and add image on all metal plates.

Code:	Description:
<b>ADPENF</b>	<b>Addition pen with fine tip</b>
<b>ADPENL</b>	<b>Addition pen with medium/large tip</b>

## Positive Deletion Gel



### Code: POSGEL

- Easy to apply - no bleeding of fluid
- Precise correction/deletion possible
- Will not attack the oxide surface of the plate
- Removes all coating residues from the plate pores

Packing: 100ml bottle / 10 x 100 bottles per box

## REVIVE! Blanket Repair



### Code: RBR250

Allows a print run to be completed despite a smash. Apply REVIVE! to the affected area using the brush applicator. Leave for several seconds and wipe clean. REVIVE! will swell the low spot back to its original level without damaging the blanket. Supplied with brush applicator.

Packing: 250ml can / 6 x 250ml cans per box

