

A *Master* PRODUCT

A *Master* PRODUCT

A *Master* PRODUCT

Duct Foils and CPC Consumables • Ink Duct End Blocks • Hickey Removers • Sheet Separators • Tower Coater Blades • Miscellaneous Products • Delivery Blowdown Fans • Pneumatic Springs • Feeder Brush Wheels • Grease Gun • Rubber Feed Board Wheels • Gripper Pad Gauge • CPC Push Buttons • O-rings (Sheet Slowdown) • Sheet hold downs • Ink Knives and Paper Wedges • Feeder Belts • Magnifying Glasses • Rubber Suckers • Wash-Up Blades • Cylinder Jackets • Recirculation Filters • Plate Correction Pens • Plate Correction Gels • Wash-Up Bottle • LubeClean • SuperClean • Ink Duct Foils and CPC Consumables • Ink Duct End Blocks • Hickey Removers • Sheet Separators • Tower Coater Blades • Miscellaneous Products • Delivery Blowdown Fans • Pneumatic Springs • Feeder Brush Wheels • Grease Gun • Rubber Feed Board Wheels • Gripper Pad Gauge • CPC Push Buttons • O-rings (Sheet Slowdown) • Sheet hold downs • Ink Knives and Paper Wedges • Feeder Belts • Magnifying Glasses • Rubber Suckers • Wash-Up Blades • Cylinder Jackets • Recirculation Filters • Plate Correction Pens • Plate Correction Gels • Wash-Up Bottle • LubeClean • SuperClean • Ink Duct Foils and CPC Consumables • Ink Duct End Blocks • Hickey Removers • Sheet Separators • Tower Coater Blades • Miscellaneous Products • Delivery Blowdown Fans • Pneumatic Springs • Feeder Brush Wheels • Grease Gun • Rubber Feed Board Wheels • Gripper Pad Gauge • CPC Push Buttons • O-rings (Sheet Slowdown) • Sheet hold downs • Ink Knives and Paper Wedges • Feeder Belts • Magnifying Glasses • Rubber Suckers • Wash-Up Blades • Cylinder Jackets • Recirculation Filters • Plate Correction Pens • Plate Correction Gels • Wash-Up Bottle • LubeClean • SuperClean

KOMI
N ■ MIEHLE ■ MULTIA
R ■ MARTINI ■ MULTIA
O ■ PHILLIPSBURG ■ RICE
■ SAKURAY ■ SANDMAR ■ SHE
■ THISEN & BONITZ ■ AB-DICK
■ WOHLEMBERG ■ REDAELLI
ER ■ AURELIA-OMSCA-REDAELLI
■ BREMER ■ C&P
G ■ MODULEN ■ DEXTER ■ DIDDIE GL
ABTREE ■ GESTETNER ■ GIANT
OHARA ■ HEIDELBERG ■ STITCHM
DELBERG ■ KLUGE ■ KOLBUS
■ MAJOR ■ M.A.N. ■ MC CAIN
■ MULLER ■ MARTI
■ PHILIP



*keep it
running...*



2021

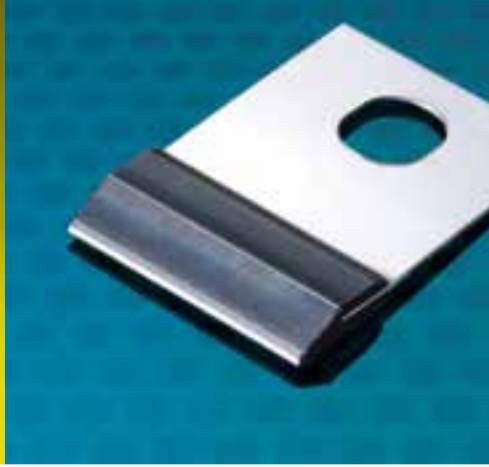

2 Ink Duct Foil and CPC Consumables

6 Ink Duct End Blocks

- Duct insulating strips
- Scraper cleaners
- Heidelberg PM/QM dampening seals
- Kompac dampening seals
- Cleaning felts (bearer wipes)

13 Performance Non-Woven Wash Cloth

14 Recirculation Filters

- Filter bags
- Eliminator ink absorbent mesh bags
- Filter mats
- Misting filters

21 Anti-Marking Paper and Film

22 Cabinet Air Filters

24 Feeder Belts and Slow Down Belts

- Belt gluing unit and belt glue

36 Sheet Separators and Feeder Brushes

46 Brush Wheels and Rubber Wheels

56 Hickey Removers

60 Master Pack Underlay Packing Paper

61 Doctor Blades and Tresu D2 Seals

- Steel and brass brushes for anilox rollers

62 Miscellaneous

- KBA – various parts
- Mitsubishi - various parts
- Komori – various parts
- Goss sheet guides

- Lifting sucker nozzles
- Blanket wash profile rubber
- Tower coater blades
- CPC buttons
- CPC Servo motors
- Festo valves and servo drives
- Plate springs
- Gauged steel (ink roller adjustment)
- Pneumatic springs
- Oil, air and fount filters
- Sheet smoothers (hold downs)
- Sheet stops (guide straps)
- O-rings
- Parts for Platen T and GT
- Tools
- Wash-up bottles, sponges, scrubbers, wiper pads, brass and steel brushes

78 Grippers and Gripper Pads

82 Ink Knives and Ink Can Openers

84 Paper Wedges, Paper Pile Corners and Reel Cutters

86 Magnifying Glasses

88 Cutting Sticks, Magnetic Pads, Knife Guards and Jogger Blocks

92 Cylinder Jackets

96 Wash-up Blades

107 Suckers

129 LubeClean – Roller Lubricating Paste Roller Master – Roller Cleaning Paste Plate Correction Pens Positive Deletion Gel Revive Blanket Repair

DISCLAIMER: Master Products featured in this publication are produced by an independent manufacturer and supplier of high quality replacement parts. The manufacturer of Master Products is not a licensee to any original equipment manufacturer ("OEM"), and disclaims any affiliation with any OEM concerning the Master Products parts. The use of an OEM name or trademark is for identification purposes only and is not intended to cause or create confusion regarding the quality, source, or sponsorship of the Master Products. Any OEM referenced in this publication is not intended to be and is not to be construed as an approval, endorsement, guarantee, promotion, recommendation, sponsorship, or warranty of the Master Products. Heidelberg, KBA, Komori, manroland, Mitsubishi and other mentioned brands are registered trademarks of their individual parent companies.



Ink Duct Foil and CPC Consumables

The Elite Foil range is manufactured to high tolerances from top-grade PET material ensuring:

- Maximum chemical, thermal and mechanical strength for long life without ink duct contamination.
- Only virgin resin suppliers are used - no recycled polyester.
- Tested using both conventional and UV inks.
- Permanently formed for a secure and accurate fit.
- Compact, low volume packaging for safe, easy and cost effective transportation and storage.

ELITE FOIL SPECIFICATIONS

| CODE | DESCRIPTION | SIZE | PACKAGING |
|----------------|--|---------------|--------------|
| 0.19mm/0.0075" | | | |
| EFOILQM | Ink Duct Foil for Heidelberg QM 46 | 358 x 200 mm | 100 foil/box |
| EFOILGT052 | Ink Duct Foil for Heidelberg GT052 | 547 x 200 mm | 100 foil/box |
| EFOILSM52 | Ink Duct Foil for Heidelberg SM52 | 547 x 197 mm | 100 foil/box |
| EFOILM0 | Ink Duct Foil for Heidelberg M0 | 676 x 200 mm | 100 foil/box |
| EFOIL72 | Ink Duct Foil for Heidelberg SM72 | 775 x 232 mm | 100 foil/box |
| EFOILSX74 | Ink Duct Foil for Heidelberg SX74 | 775 x 197 mm | 100 foil/box |
| EFOIL7475 | Ink Duct Foil For Heidelberg SM74-CD74-XL75 | 775 x 229 mm | 100 foil/box |
| EFOIL102 | Ink Duct Foil for Heidelberg SM102 | 1068 x 232 mm | 100 foil/box |
| EFOILCD105 | Ink Duct Foil for Heidelberg CX/CD102/XL105 | 1068 x 229 mm | 100 foil/box |
| EFOIL145 | Ink Duct Foil for Heidelberg XL145 | 1478 x 265 mm | 100 foil/box |
| EFOIL162 | Ink Duct Foil for Heidelberg XL162 | 1672 x 265 mm | 100 foil/box |
| EFOILW8 | Ink Duct Foil for WEB 8 | 548 x 260 mm | 50 foil/box |
| EFOILW110 | Ink Duct Foil for MC-110 | 740 x 260 mm | 50 foil/box |
| EFOILW130 | Ink Duct Foil for WEB 130 | 994 x 260 mm | 50 foil/box |
| EFOILW16 | Ink Duct Foil for WEB 16 / M600 w/foam | 1002 x 260 mm | 50 foil/box |
| EFOILW16S | Ink Duct Foil for Goss M600 w/2 notches w/foam | 1002 x 260 mm | 50 foil/box |
| 0.25mm/0.01" | | | |
| EFOIL25QM | Ink Duct Foil for Heidelberg QM 46 | 358 x 200 mm | 100 foil/box |
| EFOIL25GT052 | Ink Duct Foil for Heidelberg GT052 | 547 x 200 mm | 100 foil/box |
| EFOIL25SM52 | Ink Duct Foil for Heidelberg SM52 | 547 x 197 mm | 100 foil/box |

ELITE FOIL SPECIFICATIONS

| CODE | DESCRIPTION | SIZE | PACKAGING |
|--|---|---------------|--------------|
| EFOIL25M0 | Ink Duct Foil for Heidelberg MO | 676 x 200 mm | 100 foil/box |
| EFOIL2572 | Ink Duct Foil for Heidelberg SM72 | 775 x 232 mm | 100 foil/box |
| EFOIL25SX74 | Ink Duct Foil for Heidelberg SX74 | 775 x 197 mm | 100 foil/box |
| EFOIL257475 | Ink Duct Foil for Heidelberg SM74-CD74-XL75 | 775 x 229 mm | 100 foil/box |
| EFOIL25102 | Ink Duct Foil for Heidelberg SM102 | 1068 x 232 mm | 100 foil/box |
| EFOIL25CD105 | Ink Duct Foil for Heidelberg CX/CD102/XL105 | 1068 x 229 mm | 100 foil/box |
| EFOIL25145 | Ink Duct Foil for Heidelberg XL145 | 1478 x 265 mm | 100 foil/box |
| EFOIL25162 | Ink Duct Foil for Heidelberg XL162 | 1672 x 265 mm | 100 foil/box |
| EFOIL25W8 | Ink Duct Foil for WEB 8 | 548 x 260 mm | 50 foil/box |
| EFOIL25W110 | Ink Duct Foil for MC-110 | 740 x 260 mm | 50 foil/box |
| EFOIL25W130 | Ink Duct Foil for WEB 130 | 994 x 260 mm | 50 foil/box |
| EFOIL25W16 | Ink Duct Foil for WEB 16 / M600 w/foam | 1002 x 260 mm | 50 foil/box |
| EFOIL25W16S | Ink Duct Foil for Goss M600 w/2 notches, w/foam | 1002 x 260 mm | 50 foil/box |
| 0.25mm/0.01" FOIL IS FOR EXTREMELY LONG RUNS WITH CONVENTIONAL INK OR SHORT RUNS WITH UV INK | | | |
| 0.30mm/0.012" | | | |
| EFOIL30QM | Ink Duct Foil for Heidelberg QM 46 | 358 x 200 mm | 50 foil/box |
| EFOIL30GT052 | Ink Duct Foil for Heidelberg GT052 | 547 x 200 mm | 50 foil/box |
| EFOIL30SM52 | Ink Duct Foil for Heidelberg SM52 | 547 x 197 mm | 50 foil/box |
| EFOIL30M0 | Ink Duct Foil for Heidelberg MO | 676 x 200 mm | 50 foil/box |
| EFOIL3072 | Ink Duct Foil for Heidelberg SM72 | 775 x 232 mm | 50 foil/box |
| EFOIL30SX74 | Ink Duct Foil for Heidelberg SX74 | 775 x 197 mm | 50 foil/box |
| EFOIL307475 | Ink Duct Foil for Heidelberg SM74-CD74-XL75 | 775 x 229 mm | 50 foil/box |
| EFOIL30102 | Ink Duct Foil for Heidelberg SM102 | 1068 x 232 mm | 50 foil/box |
| EFOIL30CD105 | Ink Duct Foil for Heidelberg CX/CD102/XL105 | 1068 x 229 mm | 50 foil/box |
| EFOIL30145 | Ink Duct Foil for Heidelberg XL145 | 1478 x 265 mm | 50 foil/box |
| EFOIL30162 | Ink Duct Foil for Heidelberg XL162 | 1672 x 265 mm | 50 foil/box |
| EFOIL30W8 | Ink Duct Foil for WEB 8 | 548 x 260 mm | 50 foil/box |
| EFOIL30W110 | Ink Duct Foil for MC-110 | 740 x 260 mm | 50 foil/box |
| EFOIL30W130 | Ink Duct Foil for WEB 130 | 994 x 260 mm | 50 foil/box |
| EFOIL30W16 | Ink Duct Foil for WEB 16 / M600 w/foam | 1002 x 260 mm | 50 foil/box |
| EFOIL30W16S | Ink Duct Foil for Goss M600 w/2 notches w/foam | 1002 x 260 mm | 50 foil/box |
| 0.30mm/0.012" FOIL IS SPECIFICALLY FOR PRINTING WITH UV INK OR LONG RUNS WITH COARSE INK | | | |



CPC CONSUMABLES

Code: TESAM
00.580.1010

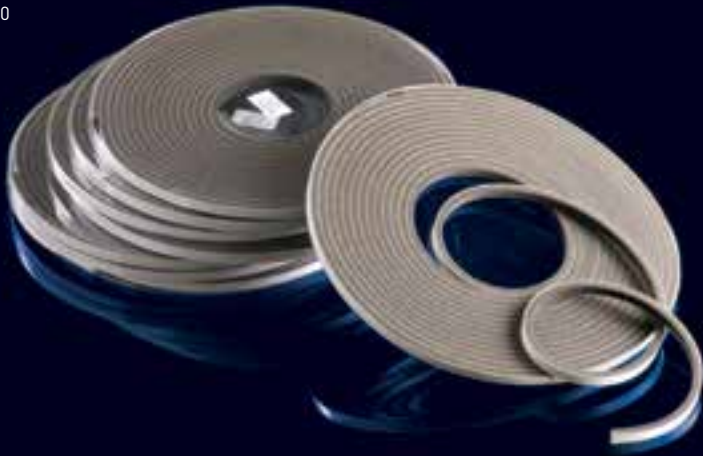

TESAMOL STRIP

An adhesive foam for placement under the ink duct foil.

Packed in a convenient clear plastic container with perforated opening for easy removal and safe storage.

9mm x 6mm x 10m/roll

Code: PUNPF Sheet-fed
00.472.006



PUNPFWEB WEB8 & WEB16
00.472.0012/0023

PROTECTIVE UNDERLAY FOIL

A two-band bi-adhesive foil for placement under the ink duct foil.

Packed in a convenient clear plastic container for safe storage.

PUNPF for sheet-fed presses
Size: 70mm x 25m/roll

PUNPFWEB for WEB 8 & 16
Size: 95mm x 25m/roll

Also available in rolls of 12 pieces pre-cut to individual press sizes.

Code: PUNPF52N 62.82.008.419F/02

Code: PUNPF7475N L2.82.008.119F/02

Code: PUNPF102105N 82.008.119F

Code: PUNPF145N 66.008.159F

Code: PUNPF162N

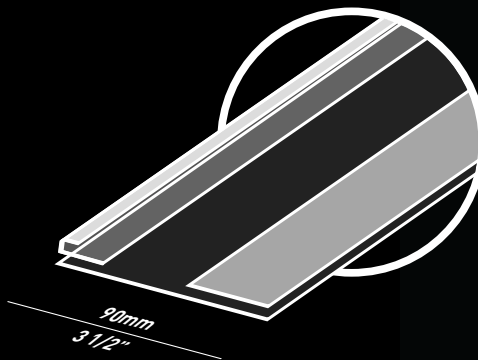

NEW PROTECTIVE UNDERLAY FOIL

New style protective underlay foil with bi-adhesive tape and hard edge profile for easy fit.

Packing: 12 pieces/box

PUNPF52N for SM52
Size: 90mm x 547mm

PUNPF7475N for SM74/CD74/XL75
Size: 90mm x 775mm

PUNPF102105N for SM102/CX-CD102/XL105
Size: 90mm x 1068mm

PUNPF145N for XL145
Size: 90mm x 1478mm

PUNPF162N for XL162
Size: 90mm x 1672mm

Ink Duct End Blocks

for Heidelberg Presses and Kompac Systems

Cleaning Felts



Master ink duct end blocks are made of the highest quality engineering grade plastic polymer (POM) which can endure high cyclic stress loading. This ensures high strength and wear resistance translating into a long life in production.

Master ink duct end blocks are precision engineered on modern CNC machines ensuring an exceptional tight fit to the ink duct roller.

Master ink duct end blocks are, wherever required, supplied with tab, screw and scraper cleaner mounted and ready to use.

INK DUCT END BLOCKS FOR HEIDELBERG

Code: IBQM46 AI.008.104/01

Model: Heidelberg QM46

Packing: 1 pair/bag

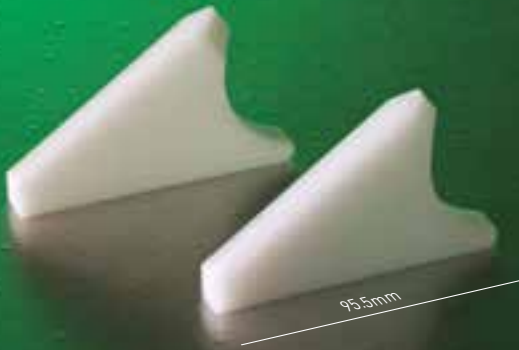

Code: IBQM46DI

A4.008.323 - O/S A4.008.324 - D/S

Model: Heidelberg QM46-DI

Packing: 1 pair/bag



Code: IBGT00A 69.008.012

Model: Heidelberg GT052 without CPT

Packing: 1 pair/bag

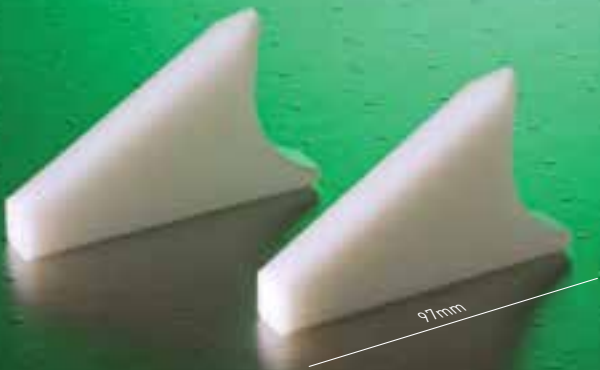

Code: IBGT00B MV.037.346

Model: Heidelberg GT052 without CPT

Packing: 1 pair/bag



Code: IBGT00C MV.022.805

Model: Heidelberg GT052 with CPC and CPT

Packing: 1 pair/bag



Code: IBWEB 5E.008.216

Model: Heidelberg WEB8/WEB12/WEB16/Harris M600

Packing: 1 pair/bag



INK DUCT END BLOCKS FOR HEIDELBERG

Code: IBSM52CC

G2.008.113 F/ - OS G2.008.112 F/ - D/S

Model: Heidelberg SM52 with CPC and CPT

Packing: 1 pair/bag



Code: IBSM520

G2.008.309 - DS G2.008.310F - OS

Model: Heidelberg SM52

without CPC and CPT

Packing: 1 pair/bag



Code: IBM02 43.008.021/02

Model: Heidelberg M0 S/N 608117+

Packing: 1 pair/bag



Code: IBM0 63.008.113

Model: Heidelberg M0

Packing: 1 pair/bag



Code: IB74 M2.008.113F/02

Model: Heidelberg SM74/PM74

Packing: 1 pair/bag



Code: IBSM748113 M1.008.113

MV.016.780/01 - OS MV.016.778/01 - DS

Model: Heidelberg SM74 without CPC

Packing: 1 pair/bag



Code: IB74CD

L2.008.114F - O/S L2.008.113F - D/S

Model: Heidelberg CD74/XL75

Packing: 1 pair/bag



Code: IB102/72 MV.025.468

91.008.013/91.008.014

Model: Heidelberg CD102/SM102/SM72

Packing: 1 pair/bag



Code: IB105

F2.008.109 - F2.008.110

Model: Heidelberg XL105/XL106

Packing: 1 pair/bag

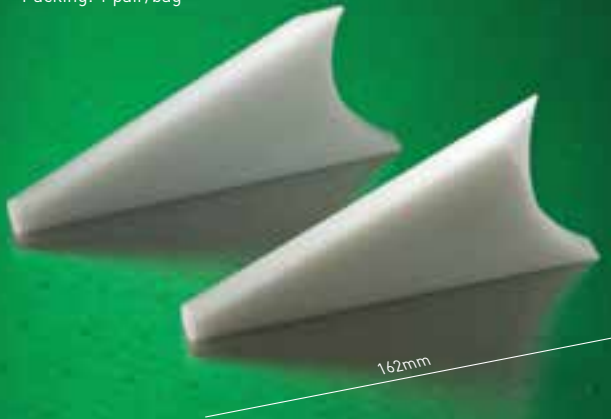

Code: IB162

G7.008.113/04 - G7.008.114/04

Model: Heidelberg XL145/XL162

Packing: 1 pair/bag

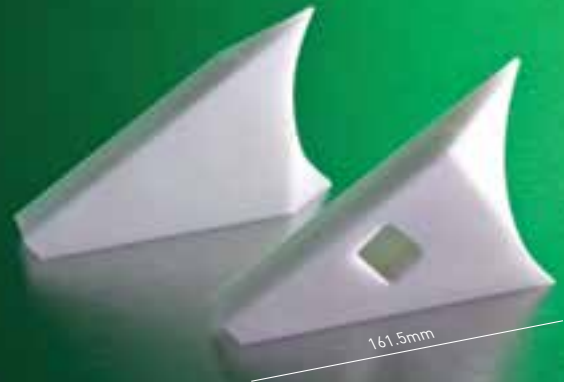

INK DUCT END BLOCKS FOR KBA

Code: IBKBA105

Model: KBA105

Packing: 1 pair/bag



GOSS

Code: IBM600 4ME008145 4ME008146

Model: Goss M600

Packing: 1 pair/bag



DUCT INSULATING STRIPS

A bi-adhesive for placement under the edge of the ink duct end block.

Code: DUCT10 91.008.044/A

10 pcs/pack @150mm x 16mm

Code: DUCT150

150 pcs/pack @150mm x 16mm

Code: IBTAB

Left and right spare tabs with screws
1 set with screws/bag



SCRAPER CLEANERS

Code: SCSHEET 91.008.033

For ink duct end blocks on Heidelberg sheet fed presses.

Packing: 25 pcs/bag



Code: SCWEB16
WM4ME008054

For ink duct end blocks on Heidelberg WEB16
Packing: 25 pcs/bag

HEIDELBERG DAMPENING SEALS

Code: SEAL46PM MV.034.739

Model: Heidelberg PrintMaster 46

Description: Dampening seals

Packing: 1 set (DS/OS)



Code: SEAL46QM MV.027.163

Model: Heidelberg QuickMaster 46

Description: Dampening seals

Packing: 1 set (DS/OS)



KOMPAC DAMPENING SEALS

Code: IBVKSMP 92370

Teflon seals for Kompac II system

For small offset press including: Ryobi, AB Dick, Adast Dominant, Chief, Gestetner, Hamada, Multilith, Rotaprint and Sakurai

Packing: 1 pair/bag



Code: IBVKGTO 90850

Teflon seals for Kompac III system, GT046/52, MO and Practika 00/01

Packing: 1 pair/bag



HEIDELBERG

CLEANING FELTS



Code: FELTPM46

Cleaning felt for PM46
Size: 360 x 30 x 3 mm
Packing: 5 pcs/pack

Code: FELTQM46

Cleaning felt for QM46
Size: 360 x 37 x 3 mm
Packing: 5 pcs/pack

Code: FELTQM46DI

Cleaning felt for QM DI 46
Size: 360 x 70 x 4 mm
Packing: 5 pcs/pack

KBA

Code: FELTKBA1

Cleaning felt for KBA RAPIDA 74
Packing: 20 pcs/pack

Code: FELTKBA2

Cleaning felt for KBA 104/105
Packing: 20 pcs/pack

Code: FELTKBA3

Cleaning felt for KBA 142/162
Packing: 20 pcs/pack

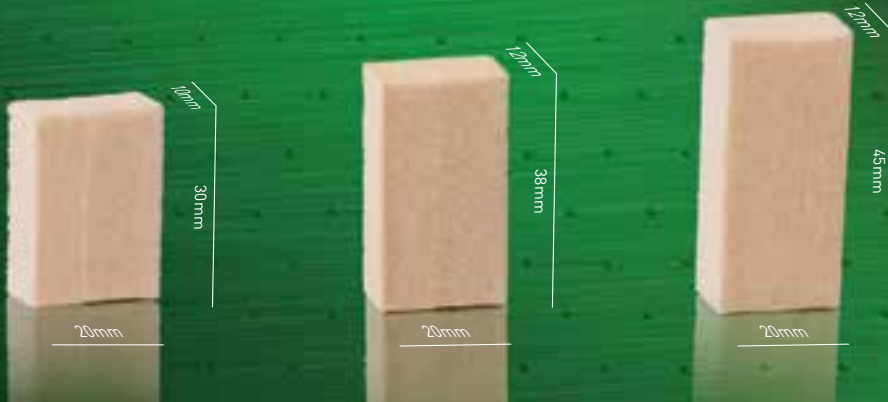

HARRIS

Code: FELTM600

Cleaning felt for Harris M600
Packing: 20 pcs/pack

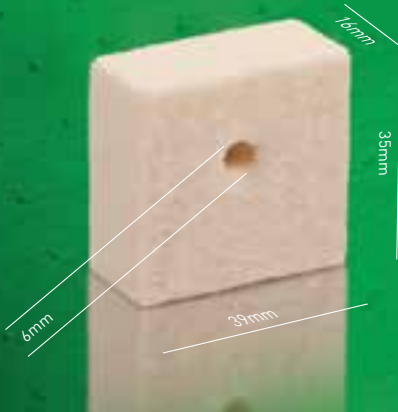

Our range of wash-up bottles can be found on page 76 in the Miscellaneous section!



KOMORI

Code: FELTK04

Cleaning felt for Komori Lithrone 28
Packing: 20 pcs/pack

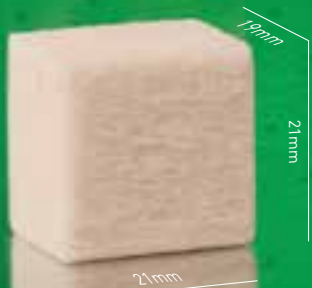

Code: FELTK05 374-9608-401

Cleaning felt for Komori
Packing: 20 pcs/pack



KOMPAC

Code: FELTVKSMP 93930

Cleaning felt for Kompac II Systems
Packing: 25 pcs/bag



Code: FELTVKGTO 94900

Cleaning felt for Kompac III Systems
Packing: 25 pcs/bag



MITSUBISHI

Code: FELTMIT3F

Cleaning felt for Mitsubishi 3F
Packing: 20 pcs/pack

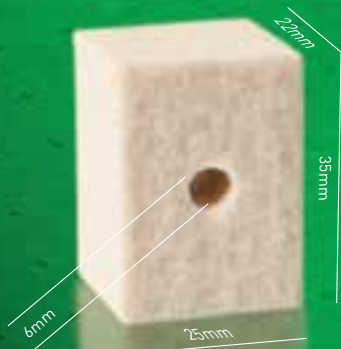

Code: FELTMIT6F

Cleaning felt for Mitsubishi 6F
Packing: 20 pcs/pack

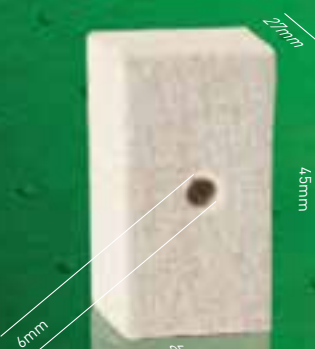

Find the new Universal Seal for Tresu D2 chambers and



our new Steel and Brass Brushes for cleaning anilox rollers are on page 61

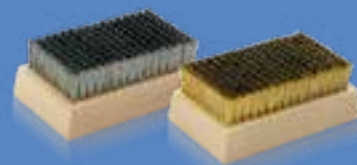



PERFORMANCE

Non-Woven wash cloth

Master Performance is a premium non-woven wash cloth specifically developed for automatic blanket cleaning systems.

Highly absorbent yet incredibly strong, Performance wash cloth removes ink, dust and impurities from the blanket quickly and completely in one safe operation without distorting or tearing under tension.

Performance cloth provides an unbeatable combination of competitive prices and excellent qualities such as:

- high tear resistance
- high absorbency
- virtually lint free
- non scratching
- effective and efficient cleaning

A perfect dot needs a clean surface!



PERFORMANCE MINI ROLLS

Each Performance mini-roll is precisely made for an exact fit giving a superior cleaning performance.

Each roll is manually inspected to ensure sharp shoulders, straight edges and correct circumference. The rolls are then packed in extra strong double sided corrugated boxes.



JUMBO ROLLS

500M jumbo rolls are available for in-house re-winding of mini-rolls.

Supplied in many sizes for all printing machines with automatic blanket cleaning systems.

Request a price list for our complete range.



TECHNICAL DATA

Performance cloth is specifically developed for Automatic Blanket Cleaning systems. It is manufactured with a mix of 55% cellulose and 45% polyester fibers utilizing a high pressure hydro-entanglement process.



WET ROLLS

Performance wet rolls are available in all standard sizes for:

Sheet-Fed Presses: Akiyama, Fuji- Shinohara, Heidelberg, KBA, Komori, Mitsubishi, Oliver Sakurai, Roland and Ryobi.

Web Presses: Goss, Heidelberg, Komori, MAN and Mitsubishi.

A Master PRODUCT

Recirculation Filters

Over 1 million recirculation filters sold!

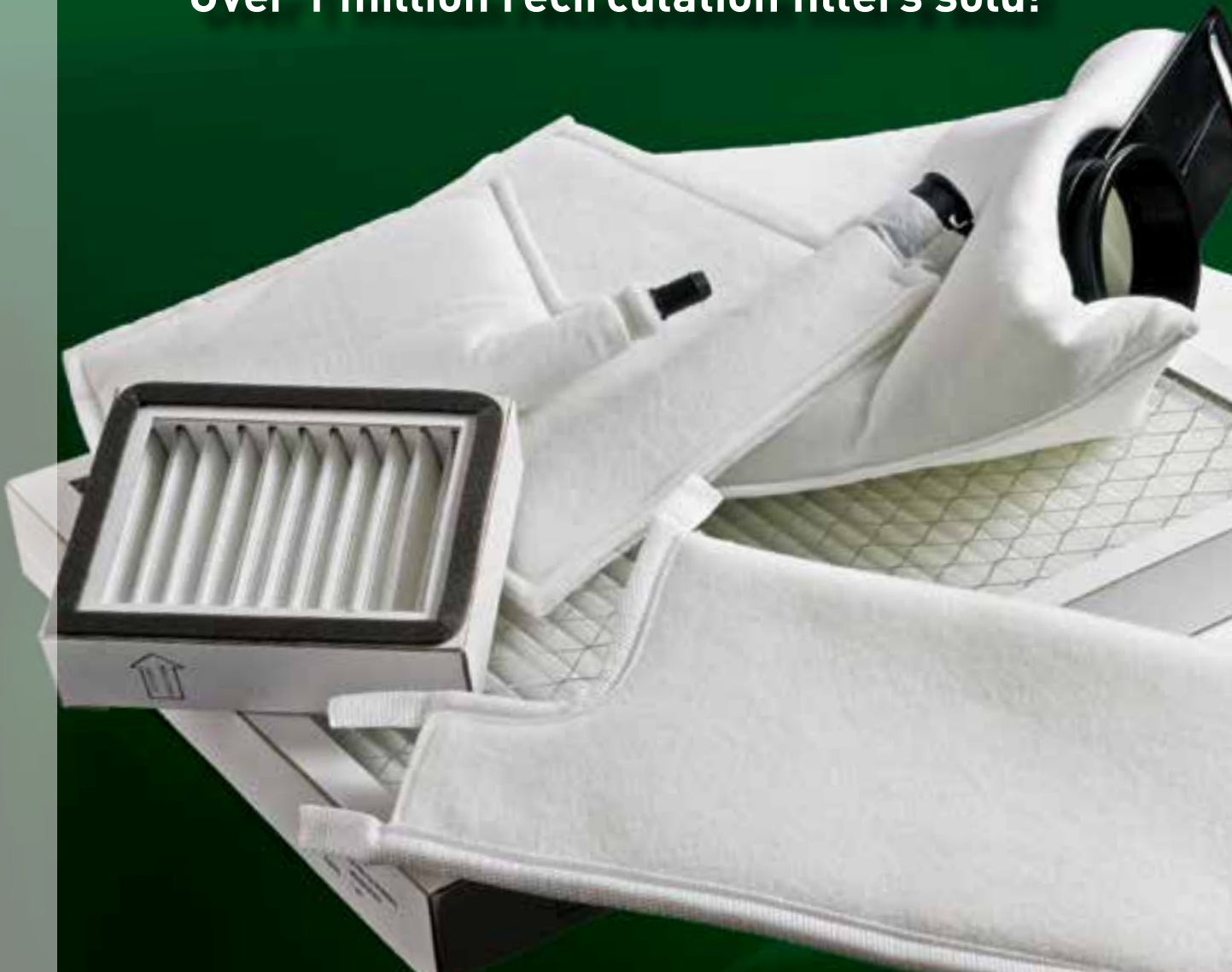

We work hard to produce high quality, high value products which enable presses everywhere to run more efficiently.

Our long line of replacement and custom designed re-circulation filters are tough, long lasting – and guaranteed to meet or exceed every printer's expectations.

Master filters of which several models are made with multi-layer design, remove most contaminants ensuring a consistently cleaner fount, improving accurate monitoring of fount conductivity, thereby reducing down time and giving long press runs and less maintenance.

Made in high quality felt, polyester or nylon, Master recirculation filters are carefully fabricated and come with a wide assortment of fittings ensuring ease of installation and compatibility with most press models on the market.

All *Master* filters undergo extensive field testing and provide a high contaminant loading and long service life.



RECIRCULATION FILTERS

Code: FILTER01

For Royse systems. Also widely used on all types of Heidelberg, Komori and Roland presses where a hose can easily be fitted to return-flow.

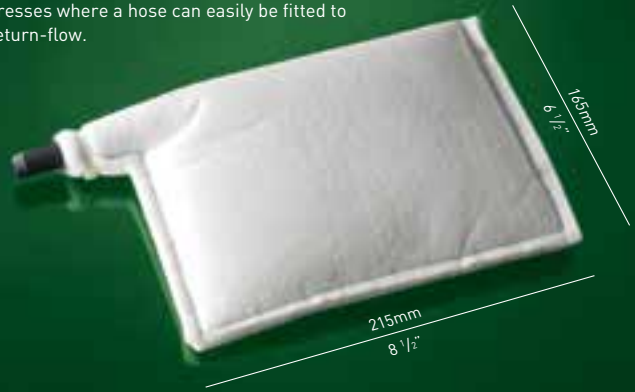

Code: FILTER02

For Master Flow systems. Also used on some Royse systems.



Code: FILTER03

For Technotrans systems (old style)



Code: FILTER04

For Technotrans systems (new style) and MG Electric Eco

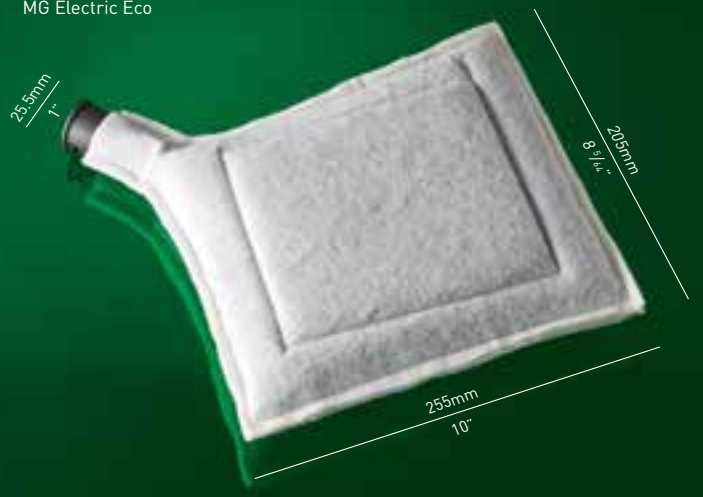

RECIRCULATION FILTERS

Code: FILTER05



Code: FILTER06

For Technotrans Alpha D systems fitted to Heidelberg, Komori, Roland and various other presses. Can also be used on Baldwin units which have similar neck fitting.



Code: FILTER07

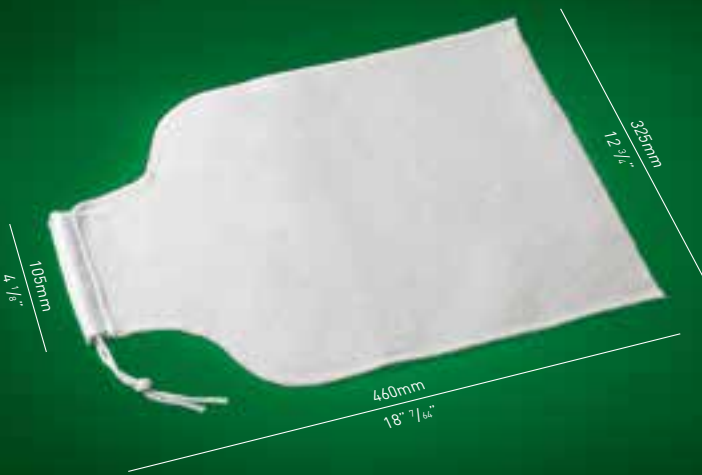

Code: FILTER08

Technotrans



Code: FILTER09



Code: FILTER10



Code: FILTER11

For Technotrans systems



Code: FILTER12



Code: FILTER13

For Technotrans and other systems

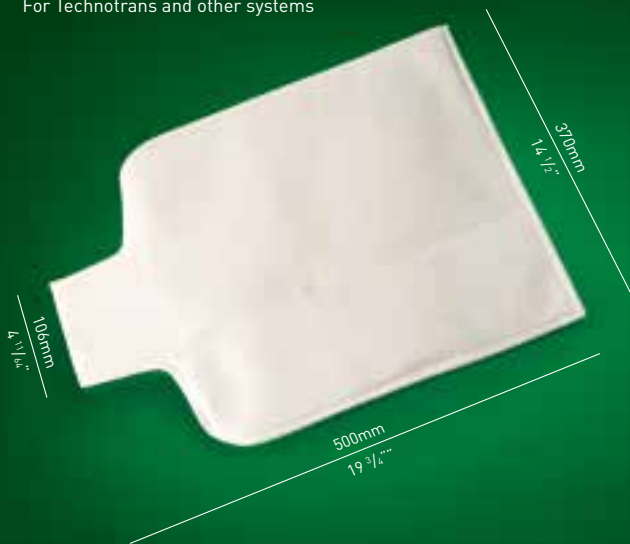

Code: FILTER14

For Royce systems



Code: FILTER15

For Baldwin (KBA/Planeta)



Code: FILTER16

Outer material nylon



RECIRCULATION FILTERS

Code: FILTER17

Outer material felt



Code: FILTER18



Code: FILTER19



Code: FILTER20

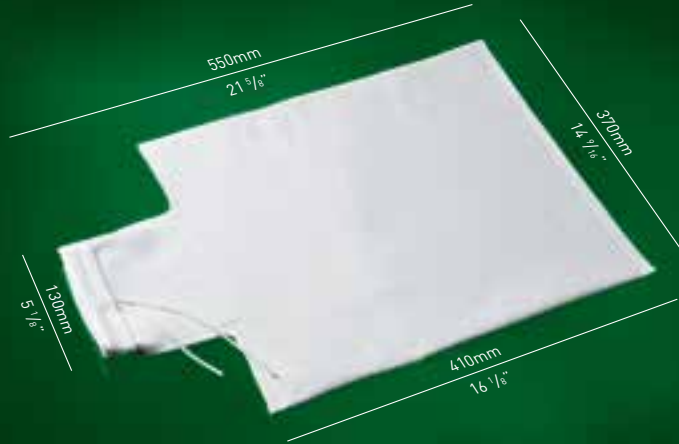

Code: FILTER21

Technotrans Delta C

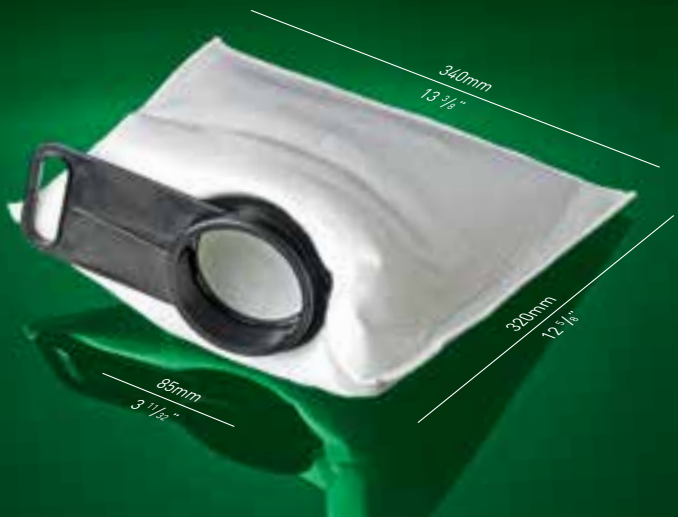

Code: FILTER22



Code: FILTER28 L6.187.2125/01

For Technotrans systems



Code: FILTER29



Note:
Avoid mistake between
FILTER15 and FILTER29.
FILTER15 is 10mm shorter
and the most popular size.

ELIMINATOR



Removes emulsified ink!

The Eliminator is a durable nylon-mesh bag filled with ink absorbent material which effectively prevents contamination of the dampening system.

Simply place the Eliminator in the circulation tank and it will float on the surface of the fountain solution removing all emulsified ink.

Size: 200x115x25mm 8"x4 1/2"x1"

Packing: 8 pcs/box

FILTER MATS



Code:

| | |
|---------------------|-----------------------|
| FM152 x 340 | 6" x 13 25/64" |
| FM152 x 465 | 6" x 18 5/16" |
| FM170 x 470 | 6 11/16" x 18 1/2" |
| FM180 x 280 | 7 3/32" x 11" |
| FM190 x 290 | 7 31/64" x 11 27/64" |
| FM200 x 280 | 7 7/8" x 11" |
| FM200 x 310 | 7 7/8" x 12 13/64" |
| FM200 x 320 | 7 7/8" x 12 19/32" |
| FM200 x 400 | 7 7/8" x 15 3/4" |
| FM200 x 440 | 7 7/8" x 17 21/64" |
| FM240 x 710 | 9 29/64" x 27 61/64" |
| FM250 x 250 | 9 29/64" x 9 29/64" |
| FM250 x 300 | 9 27/32" x 11 13/16" |
| FM250 x 330 | 9 27/32" x 13" |
| FM250 x 400 | 9 27/32" x 15 3/4" |
| FM250 x 470 | 9 27/32" x 18 1/2" |
| FM250 x 670 | 9 27/32" x 26 3/8" |
| FM255 x 635 | 10 3/64" x 25" |
| FM275 x 470 | 10 53/64" x 18 1/2" |
| FM275 x 780 | 10 53/64" x 30 45/64" |
| FM300 x 400 | 11 13/16" x 15 3/4" |
| FM305 x 1150 | 12" x 45 9/32" |
| FM315 x 660 | 12 13/32" x 26" |
| FM360 x 360 | 14 11/64" x 14 11/64" |
| FM400 x 400 | 15 3/4" x 15 3/4" |
| FM400 x 900 | 15 3/4" x 35 7/16" |
| FM470 x 500 | 18 1/2" x 19 11/16" |
| FM500 x 500 | 19 11/16" x 19 11/16" |
| FM500 x 750 | 19 11/16" x 29 17/32" |
| FM 30M x 1M | 118 7/64" x 39 3/8" |

Packing: 4 pcs/pack

MISTING FILTERS

Code: **FILTERMIST01** F4.010.102/02A

Misting filter for Heidelberg XL105

Size 1060 x 120 x 20mm

41 47/64" x 4 23/32" x 25/32"

Packing: 6 pcs/pack 2 packs/box

Code: **FILTERMIST02** F4.010.214/F

Misting filter for Heidelberg XL106

Size: 1155 x 365 x 20mm

45 1/2" x 14 1/2" x 25/32"

Packing: 6 pcs/pack 2 packs/box



Master Anti-Marking Systems

The Master anti-marking film and paper is coated with a uniform layer of over 2500 microscopic silicon glass beads per sq/cm.

The ink repellent glass beads prevent ink smearing on the transfer cylinders and ensure that only the smallest possible area is in direct contact with the wet ink during transfer of the printed sheet. The net result is less marking and much less down time.

Bonded to the backing substrate with a hardened polyurethane adhesive both the anti-marking film and paper are resistant to ink, oil, standard press wash-up solvents and water.

Anti-Marking Paper

This oil impregnated, dimensionally stable paper, offers the most economical solution to problems with marking.

Universal Model
Code: AMP
Size/roll: 1150mm x 20m
Packing: 4 rolls/carton

Anti-Marking Film

The premium quality anti-marking product with polyester backing. Extremely durable and favored by most printers. Available in two models:

Fine Code: AMF
Coarse Code: AMFC
Size/roll: 1150mm x 50m
Packing: 1 roll/carton

Anti-Marking Film Self-Adhesive

Also with polyester backing but with the added benefit of a self-adhesive backing for quick and easy installation. Available in two models:

Fine Code: AMFA
Coarse Code: AMFAC
Size/roll: 1050mm x 25m
Packing: 1 roll/carton

Easy Installation:

Installation is simple:
Clean the surface of the transfer and delivery cylinders.

Smooth the film onto the cylinders using either the:

- self-adhesive backing of the AMF-A or
- in case of the AMP paper or AMF film by using double sided adhesive tape or spray-on adhesive.

No press modifications are necessary.

Quick Cleaning:

To keep the AMF and AMP in perfect running condition occasionally wipe it down with a rag wetted with a mild or diluted press wash solution.

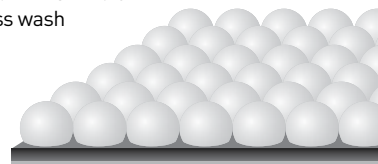

Red cylinders indicate a typical installation of anti-marking film or paper.

Universal Application:

The AMF and AMP can be used by all commercial printers on both coated and non-coated paper, from light to heavy stock.

- Long lasting top quality anti-marking system at affordable price
- Simple, cost effective alternative to other anti-marking products and air drums
- Prevents costly wasted sheets due to ink build-up on transfer and delivery cylinders
- Quick and easy to install - no press modifications or cylinder surface treatments needed
- Resistant to ink, oil, standard press wash-up solvents and water
- Uniform thickness - dimensionally stable base substrate

For more Anti-Marking products please enquire about our:

- Anti-Marking Nets
- Anti-Marking Jackets
- Anti-Marking Paste

Cabinet Air Filters

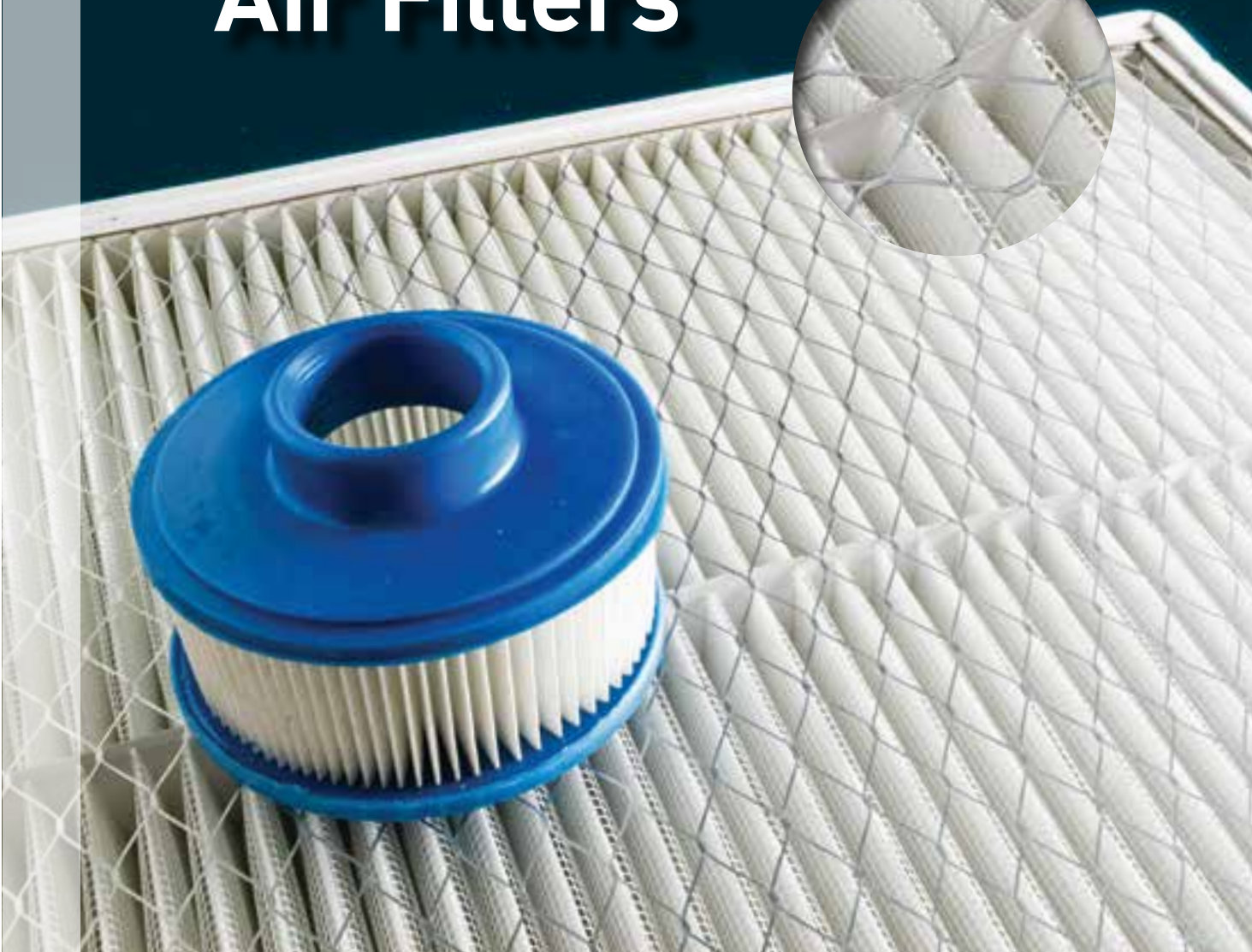

AIR FILTERS

22

AIR FILTERS

Code: AFH3702 00.780.3702

Description: Air filter for spray powder unit SORM/SORD/SORS/MO/SM102/CD102

Packing: 1 piece

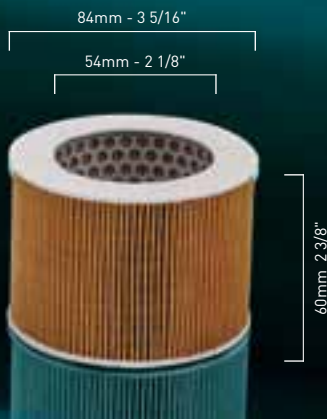

Code: AFH8106 47.018.106

Description: Air filter for SM74/CD74/SM102/CD102/SX/CX/XL

Packing: 1 piece



Code: AFH4992 00.580.4992

Description: Air filter for SM/CD/CX/SX/XL presses

Packing: 1 piece



AIR FILTERS

Code: AF170140

Size: 170x140x47mm
6 11/16 x 5 33/64 x 1 27/32"



Code: AFH5379 00.580.5379

Large air filter for Heidelberg

129mm - 5 1/16"
44mm - 1 47/64"



80mm 3 5/32"

Old Code: AIRFILTHL

Code: AFH6146 00.580.6146

Small air filter for Heidelberg

43mm - 1 11/16"
20mm - 25/32"



89mm 3 1/2"

Old Code: AIRFILTHS

Code: AF750480

Size: 750 x 480 x 47mm - 29 17/32 x 18 57/64 x 1 3/4"



Code: AF730160 00.580.5832

Size: 730 x 160 x 47mm - 28 47/64 x 6 19/64 x 1 3/4"



Code: AF700140 C2.102.1911

Size: 700 x 140 x 47mm - 27 9/16 x 5 33/64 x 1 3/4"

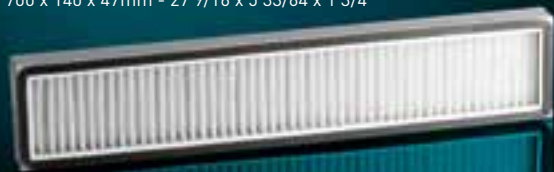

Code: AF495394 F2.179.1821

Size: 495 x 394 x 45mm - 19 31/64 x 15 33/64 x 1 3/4"



Code: AF650400 FS.102.3801/02

Size: 650 x 400 x 47mm - 25 9/16" x 15 3/4" x 1 3/4"



Feeder Belts and Slow Down Belts

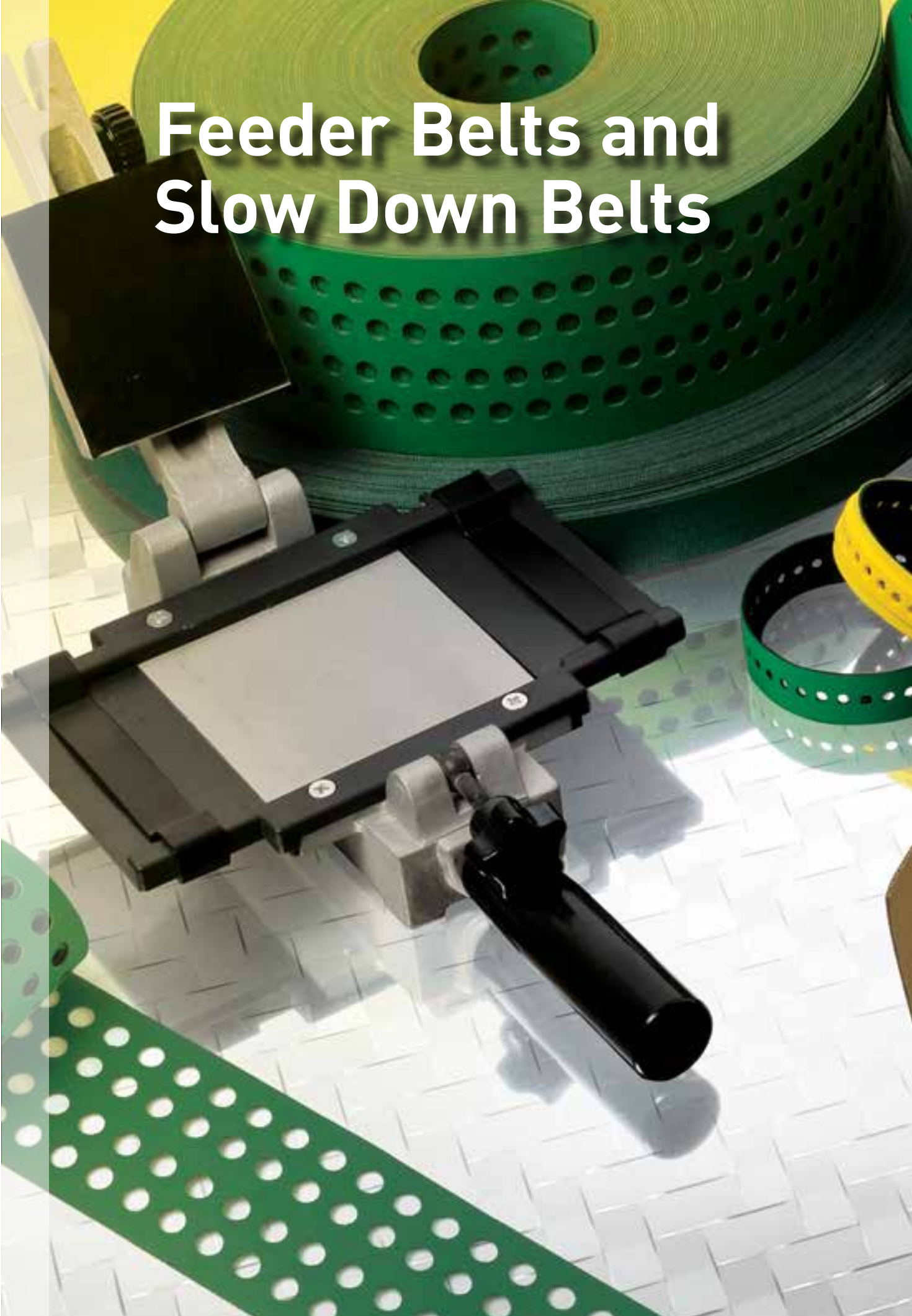



Quality belts for the printing industry!

Using the best materials available and state-of-the-art manufacturing equipment our team of professionals can assure you of a superb product.

Master Belts are found throughout the printing industry handling the most demanding belt applications.

We supply all types of belts elastomer, wear resistant polyurethane, woven endless, self tracking, vacuum, with or without carcass, covered, sealed, fused and anti-static you name it and we can make it to your specifications.

Our computerized punching machines can make almost any pattern of round perforations for vacuum belts and other shapes may be available with extra charge for tooling or special die.

Let us work with you toward a profitable, top quality product guaranteed to meet your highest expectations.

HEIDELBERG

FEEDER BELTS

26

FEEDER BELTS

Code: FB102 86.020.029

Model: Heidelberg SM102/72

Size: 2015 x 28mm/79 21/64" x 1 7/64"

Packing: 1 piece

Code: FBSOZ 66.020.029

Model: Heidelberg SORKZ/SORMZ/SORDZ

Size: 2015 x 28mm/79 21/64" x 1 7/64"

Packing: 1 piece

Code: FBSO 66.020.080/F

Model: Heidelberg SORK/SORM/SORD

Size: 1465 x 28mm/57 43/64" x 1 7/64"

Packing: 1 piece

Code: FBMO 53.020.029

Model: Heidelberg MO

Size: 1375 x 25mm/54 9/64" x 63/64"

Packing: 1 piece

Code: FB52 89.020.007

Model: Heidelberg GT052 - Perforated

Size: 1220 x 89mm/48 1/32" x 3 1/2"

Packing: 1 piece

Code: FBSM52 G2.020.009

Model: Heidelberg SM52 - Endless

Size: 950 x 60mm/37 13/32" x 2 23/64"

Packing: 1 piece



Code: FB74

Model: Heidelberg SM74

Description: One set comprising:
1 piece FB74N & 1 piece FB74P

Packing: 1 set/box



M2.020.017

Code: FB74N

Model: Heidelberg SM74

Size: 1265 x 54mm/49 3/4" x 2 1/8"

Packing: 1 piece



Code: FB74P M2.020.017

Model: Heidelberg SM74 - Perforated

Size: 1265 x 54mm/49 3/4" x 2 1/8"

Perforated

Packing: 1 piece



Code: FB102105 F4.020.292/02

Model: SM102/CD102/XL105 - Endless

Size: 2890 x 210mm/113 25/32" x 8 17/64"

Packing: 1 piece



Code: FBCD74 L2.020.014

Model: Heidelberg SM74/CD74/XL75 - Endless

For post 2006 presses

Size: 2428 x 138mm/95 19/32" x 5 7/16"

Packing: 1 piece



Code: FB741410

Model: Heidelberg SM74 - Endless

Size: 1410 x 85mm/55 1/2" x 3 11/32"

Packing: 1 piece



AKIYAMA

Code: FBAB28

Model: Akiyama Bestech 28

Size: 1660 x 28mm/65 23/64" x 1 7/64"

Packing: 1 piece



RYOBI

Code: FBRYOBI

Model: Ryobi 755 - Perforated

Size: 1780 x 50mm /70 5/64" x 1 31/32"

Packing: 1 piece



KBA

Code: FBKBA104

Model: KBA Rapida 104/105

Size: 2627 x 28mm/103 27/64" x 1 7/64"

Packing: 1 piece

Code: FBKBA142

Model: KBA Rapida 142/162

Size: 3185 x 40mm/125 25/64" x 1 5/8"

Packing: 1 piece

Code: FBKBAP1

Model: KBA Rapida - Perforated

Size: 2060 x 80mm/81 7/64" x 3 5/32"

Packing: 1 piece

Code: FBKBAP2

Model: KBA Rapida 142/162 - Perforated

Size: 3160 x 80mm/124 13/32" x 3 5/32"

Packing: 1 piece

Code: FBKBAP3

Model: KBA Rapida 142/162 - Perforated

Size: 3190 x 100mm/125 19/32" x 3 15/16"

Packing: 1 piece



KOMORI



Code: FBKS26

Model: Komori Sprint 26"

Size: 1448 x 28mm/57 x 1 7/64"

Packing: 1 piece

Code: FBKL26

Model: Komori Lithrone 26"

Size: 1680 x 25mm/66 9/64" x 63/64"

Packing: 1 piece

Code: FBKL28

Model: Komori Lithrone 28"

Size: 1975 x 25mm/77 3/4" x 63/64"

Packing: 1 piece

Code: FBKL40

Model: Komori Lithrone 40"

Size: 2400 x 25mm/94 1/2" x 63/64"

Packing: 1 piece

MITSUBISHI



Code: FBMIT3FE

Model: Mitsubishi 3F/E

Size: 1980 x 25mm/77 61/64" x 63/64"

Packing: 1 piece

Code: FBMIT3G4

Model: Mitsubishi 3G-4

Size: 2205 x 25mm/86 13/16" x 63/64"

Packing: 1 piece

Code: FBMIT3F6

Model: Mitsubishi 3F-6

Size: 2345 x 25mm/92 21/64" x 63/64"

Packing: 1 piece

Code: FBMIT4G5

Model: Mitsubishi 4G-5

Size: 2465 x 25mm/97 3/64" x 63/64"

Packing: 1 piece



Code: FB0B

Model: Roland OB

Size: 1356 x 28mm/53 25/64" x 1 7/64"

Packing: 1 piece

Code: FB3B

Model: Roland Rekord 3B

Size: 1977 x 28mm/77 53/64" x 1 7/64"

Packing: 1 piece

Code: FB600

Model: Roland 600

Size: 1500 x 28mm/59 1/16" x 1 7/64"

Packing: 1 piece

Code: FBOBP

Model: Roland OB - Perforated

Size: 1356 x 50mm/53 25/64" x 1 31/32"

Packing: 1 piece

Code: FB200

Model: Roland 200 - Perforated

Size: 1440 x 50mm/56 11/16" x 1 31/32"

Packing: 1 piece

Code: FB300

Model: Roland 300 - Perforated

Size: 1070 x 50mm/42 1/8" x 1 31/32"

Packing: 1 piece

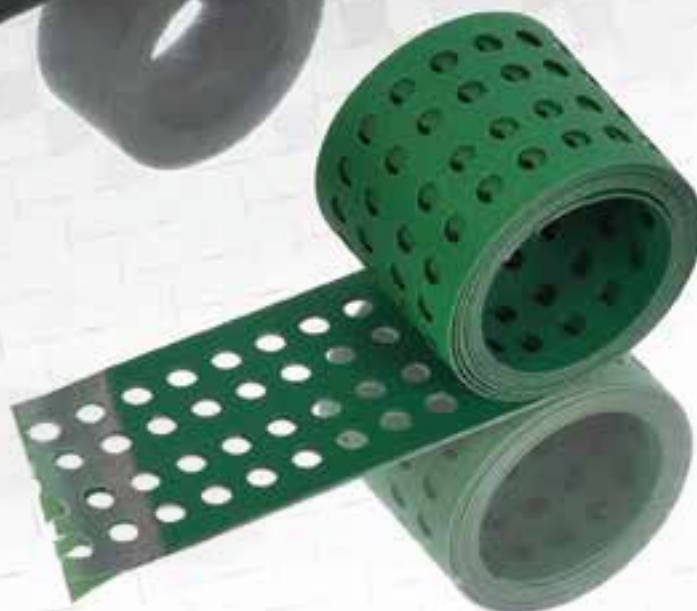

Code: FB700

Model: Roland 700 - Perforated

Size: 2880 x 80mm/113 25/64" x 3 5/32"

Packing: 1 piece

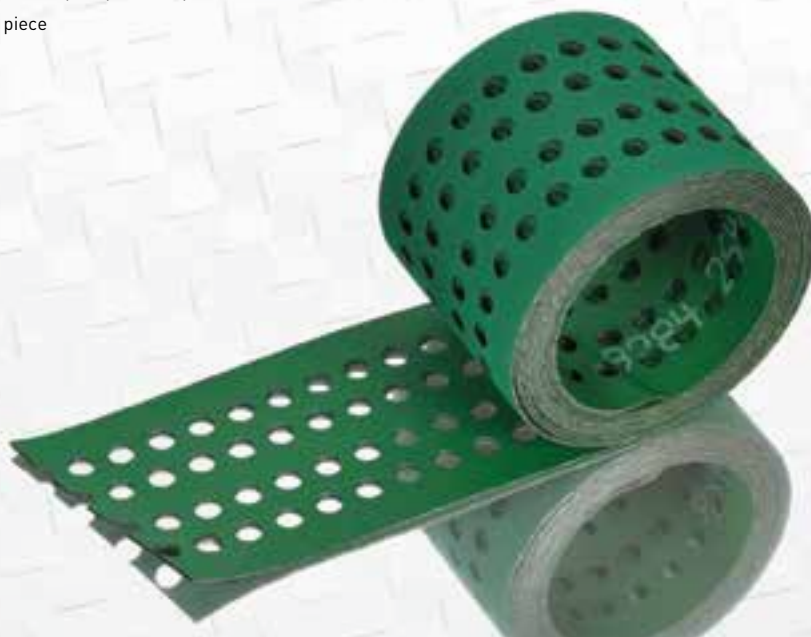

BELT GLUING UNIT

Code: KADH

Strong glue for belts

10ml/bottle - 15 bottles/box

BELT *Master* BELT GLUING UNIT

Code: BMGM

- For belt width up to 90mm/3 1/2"
- Even heat distribution
- Automatic temperature regulation
- Light, handy and easy to use

UNIQUE PACKAGING

HEIDELBERG M0
Code: FBM0



For easy handling and safe storage with clear, precise labeling detailing product code, press model, length and width.

PERFECT SKIVING

HEIDELBERG SM74
Code: FB74N

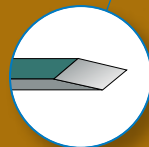

For accurate and easy assembly!

PERFORATED BELTS

HEIDELBERG SM52
Code: FBSM52

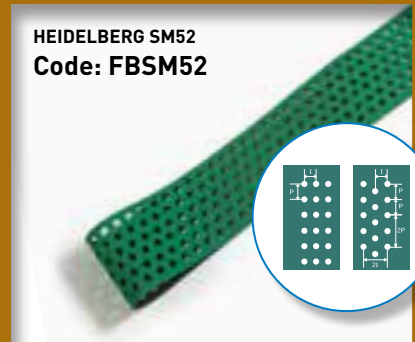

Perforations enable the belts to have air suction ensuring the material is conveyed as intended and also allows for cooling air to pass through.

Examples of precise perforation patterns. Perforations can be executed according to customer's specifications.

SLOW DOWN BELTS - HEIDELBERG

Code: FB74SSFG M2.015.881F/

Model: SM102/CD102/XL105

Description: Grey/Flat

Size: 225 x 20mm

Packing: 1 piece



Code: FB74SSG M2.015.843F/

Model: SM52/SM74/XL75/SM102/XL105

Description: Grey/9mm raised

Size: 225 x 20mm

Packing: 1 piece



Code: FB74SSG5 M2.015.898F/

Model: SM52/SM74/SM102/XL105

Description: Grey/5mm raised

Size: 225 x 20mm

Packing: 1 piece



Code: FB74SSFY M2.015.878/

**Model: SM52/SM74/CD102/XL105/
XL145/XL162**

Description: Yellow/Flat

Size: 225 x 20mm

Packing: 1 piece



Code: FB74SSY M2.015.840F/

**Model: SM52/SM74/XL75/SM102/ CD102/
XL105**

Description: Yellow/9mm raised

Size: 227 x 20mm

Packing: 1 piece



Code: FB74SSY5 M2.015.896F/01

**Model: SM52/SM74/SM102/CD102/
XL105**

Description: Yellow/5mm raised

Size: 227 x 20mm

Packing: 1 piece



Code: FB74SSGRS M2.015.872/01

**Model: SM52/SM74/SM102/CD102/
XL105**

Description: Grey/1.5mm raised

Size: 225 x 20mm

Packing: 1 piece



Code: FB74SSCDFG F4.614.831F/

**Model: SM102/CD102/XL75/XL105/
XL145/XL162**

Description: Grey/Flat

Size: 247 x 20mm

Packing: 1 piece



Code: FB74SSCDG F4.614.821F/

Model: SM102/CD102/XL75/XL105

Description: Grey/9mm raised

Size: 247 x 20mm

Packing: 1 piece



Code: FBSSFXL M2.015.880/

**Model: SM102/CD102/XL75/XL105/
XL145/XL162**

Description: Green/Flat

Size: 235 x 20mm

Packing: 1 piece



Code: FBSSXLB-F F4.614.871/

Model: SM102/XL75/XL105/XL145/XL162

Description: Blue/7mm raised

Size: 245 x 10mm

Packing: 1 piece



Code: FBSSXLG F4.614.861/

Model: SM102/XL75/XL105/XL145/ XL162

Description: Grey/7mm raised

Size: 245 x 10mm

Packing: 1 piece



Code: FBSSXLB F4.614.560/01

Model: SM102/XL75/XL105/XL145/XL162

Description: Blue/7mm grooved

Size: 245 x 10mm

Packing: 1 piece



Code: FBSSXLW F4.614.881F/

Model: SM102/XL75/XL105/XL145/XL162

Description: White/7mm grooved

Size: 245 x 10mm

Packing: 1 piece



Code: FBSSXLR F4.614.570/

Model: SM102/XL75/XL105/XL145/XL162

Description: Red/7mm grooved

Size: 245 x 10mm

Packing: 1 piece



Code: FBSSXLP F4.614.891F/

Model: SM102/XL75/XL105/XL145/XL162

Description: Pink/7mm grooved

Size: 245 x 10mm

Packing: 1 piece



Code: FBSSXLT F4.614.885F/

Model: SM102/XL75/XL105/XL145/XL162

Description: Yellow (Tan)/7mm grooved

Size: 245 x 10mm

Packing: 1 piece



LubeClean
LUBRICATES AND CLEANS!



REFER TO
PAGE 128

Code: LUBECLEAN

Packing: 900 gram (2.0 lbs)/can - 12 cans/box

SLOW DOWN BELTS - HEIDELBERG

Code: FB102SS C3.015.453/

Model: SM74/SM102/CD102

CD102 s/n 543064+ SM74 s/n 621124+

Description: Green/Perforated

Size: 215 x 38mm

Packing: 1 piece



Code: FB102SSC C3.015.653/

Model: SM102/CD102

Description: Green/12mm raised compressible

Size: 215 x 38mm

Packing: 1 piece



Code: FB74SSP M2.015.357/01

Model: SM74

Description: Pink/10mm raised

Size: 220 x 38mm

Packing: 1 piece



SLOW DOWN BELTS - KOMORI

Code: FBKD GFH-8310-956

Model: KOMORI

Description: Black

8mm raised/26 holes

Size: 210 x 14mm

Packing: 1 piece



Code: FBKS GFH-8310-902

Model: KOMORI

Description: Black

7mm raised/26 holes

Size: 210 x 14mm

Packing: 1 piece



Code: FBKX ZPO-8300-101

Model: KOMORI

Description: Black

5mm raised/35 holes

Size: 210 x 14mm

Packing: 1 piece



Code: FBKN GFH-8310-9S0

Model: KOMORI

Description: Black

5mm raised/52 holes

Size: 210 x 14mm

Packing: 1 piece



WEKO

Code: FBWEK0460 00.780.0476

Model: Weko T6/T66 spray unit

Description: Yellow/Flat

Size: 460 x 12 x 1mm

Packing: 1 piece



Code: FBWEK0490 00.780.0475

Model: Weko T6/T66 spray unit

Description: Yellow/Flat

Size: 490 x 12 x 1mm

Packing: 1 piece



SLOW DOWN BELTS - MITSUBISHI

Code: FBSSMIT1

Model: Mitsubishi

Description: Black/6mm raised/30 holes

Size: 214 x 14mm

Packing: 1 piece



Code: FBSSMIT2

Model: Mitsubishi

Description: Black/5mm raised/41 holes

Size: 214 x 14mm

Packing: 1 piece



Code: FBSSMIT3

Model: Mitsubishi

Description: Black/8mm raised/23 holes

Size: 214 x 14mm

Packing: 1 piece



KBA

Code: FBSSKBA5 P7721771

Model: KBA

Description: Black/Flat 32 holes

Size: 235 x 10mm

Packing: 1 piece



Code: FBSSKBA6 P7074890

Model: KBA

Description: Black/Flat 32 holes

Size: 235 x 15mm

Packing: 1 piece



Code: FBSSKBA7

Model: KBA

Description: Grey/Flat 41 holes

Size: 286 x 20mm

Packing: 1 piece



Sheet Separators Feeder Brushes

SHEET SEPARATORS

36

SHEET SEPARATORS

KOMORI

Code: SHEETB30

Model: Komori SX40

Description: Bent sheet separator

Thickness: 0.15mm / 0.006"

Packing: 12 pcs/bag

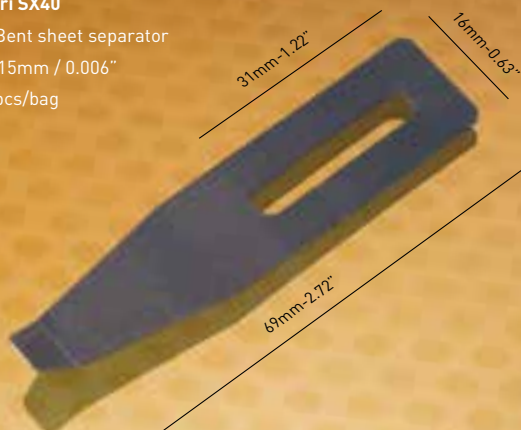

Code: SHEETB35 444.1689.024

Model: Komori LS

Description: Bent sheet separator

Thickness: 0.08mm / 0.003"

Packing: 12 pcs/bag

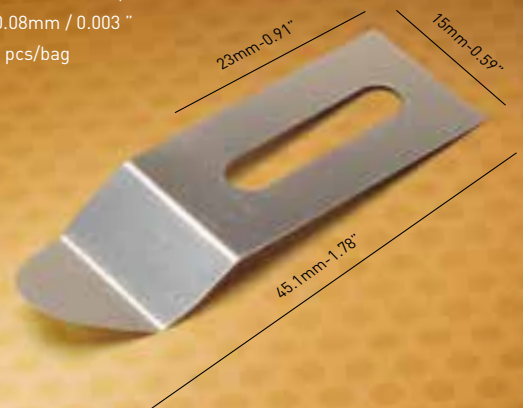

UNIVERSAL

| Code | Thickness (mm/inch) |
|-----------------|------------------------|
| SHEET101 | 0.10mm / 0.004" |
| SHEET102 | 0.20mm / 0.008" |
| SHEET103 | 0.30mm / 0.012" |

Model: Heidelberg/Roland/Mitsubishi/KBA/Miller

Description: Flat sheet separator
Packing: 25 pcs/bag

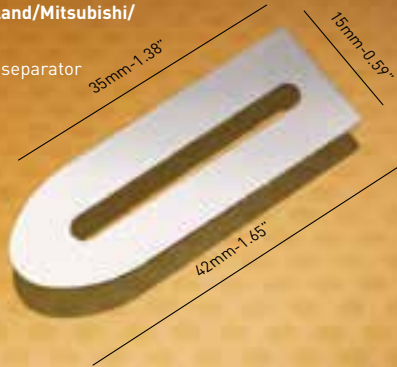

HAMADA - MULTILITH

Code: SHEET8015

Model: Hamada/Multilith 1250
Description: Bent sheet separator
Thickness: 0.15mm / 0.006"
Packing: 12 pcs/bag

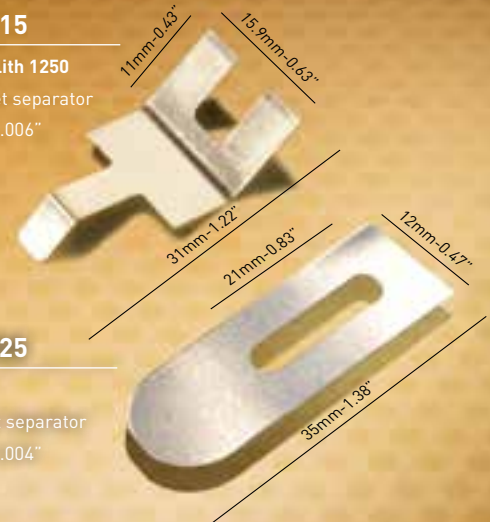

Code: SHEET8025

Model: Hamada
Description: Flat sheet separator
Thickness: 0.10mm / 0.004"
Packing: 25 pcs/bag

| Code | Thickness (mm/inch) |
|-----------------|------------------------|
| SHEET201 | 0.10mm / 0.004" |
| SHEET202 | 0.20mm / 0.008" |
| SHEET203 | 0.30mm / 0.012" |

Model: Komori/Fuji-Shinohara/Hashimoto

Description: Flat sheet separator
Packing: 25 pcs/bag

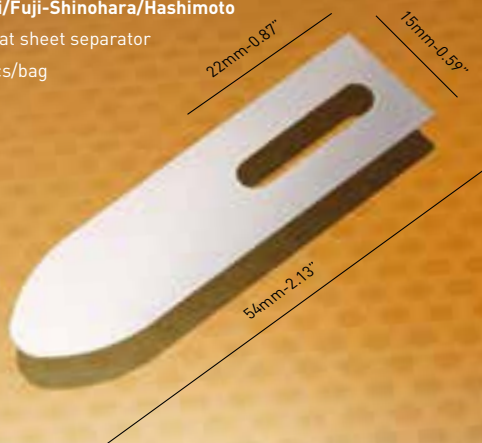

| Code | Thickness (mm/inch) |
|-----------------|------------------------|
| SHEET301 | 0.10mm / 0.004" |
| SHEET302 | 0.20mm / 0.008" |
| SHEET303 | 0.30mm / 0.012" |

Model: Komori/Fuji-Shinohara/Hashimoto

Description: Flat sheet separator
Packing: 25 pcs/bag

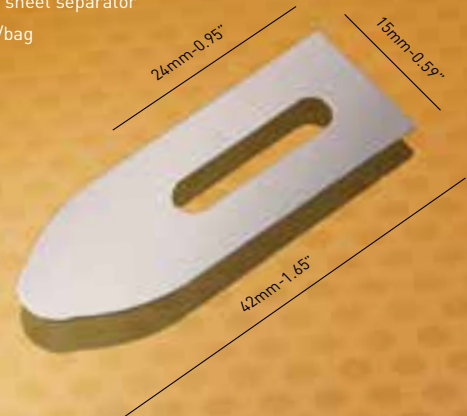

KOMORI

Code
SHEETK01L
CA26477A00
Thickness (mm/inch)
0.30mm / 0.012"

Model: KOMORI GL40

Description:
Bent sheet separator
- Left
Packing: 1 piece



Code
SHEETK01R
CA26478A00

Thickness (mm/inch)
0.30mm / 0.012"

Model: KOMORI GL40

Description:
Bent sheet separator - Right
Packing: 1 piece

SAKURAI

| Code | Thickness (mm/inch) |
|-----------------|------------------------|
| SHEET601 | 0.10mm / 0.004" |
| SHEET602 | 0.20mm / 0.008" |
| SHEET603 | 0.30mm / 0.012" |

Model: Sakurai

Description: Flat sheet separator
Packing: 25 pcs/bag

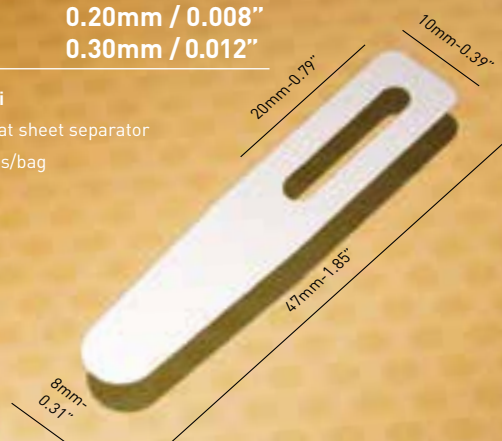

HEIDELBERG

Code: SHEETF1

Model: Speedmaster/S-Offset

Description: Fork with flat frame

Thickness: 0.2mm / 0.008"

Packing: 1 piece

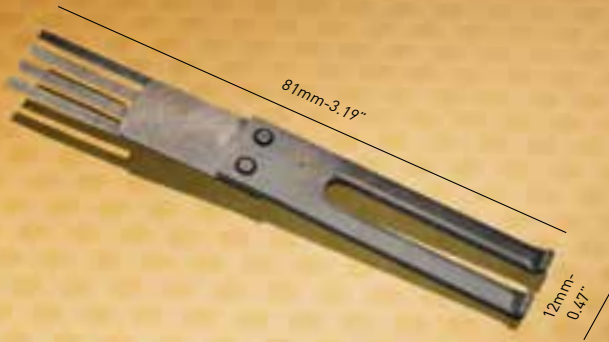

Code: SHEETF2

Model: Speedmaster/S-Offset

Description: Blade with flat frame

Thickness: 0.2mm / 0.008"

Packing: 1 piece

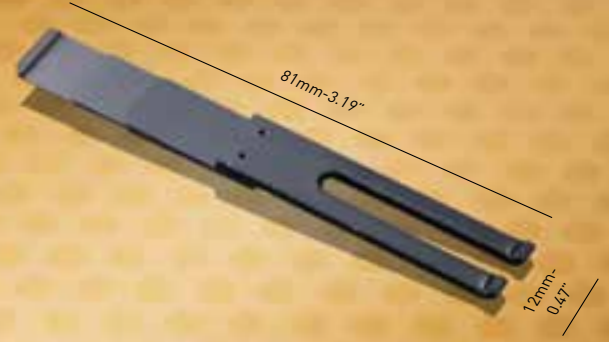

Code: SHEETB1 66.028.810F/01

Model: Speedmaster/S-Offset

Description: Fork with bent frame

Thickness: 0.2mm / 0.008"

Packing: 1 piece

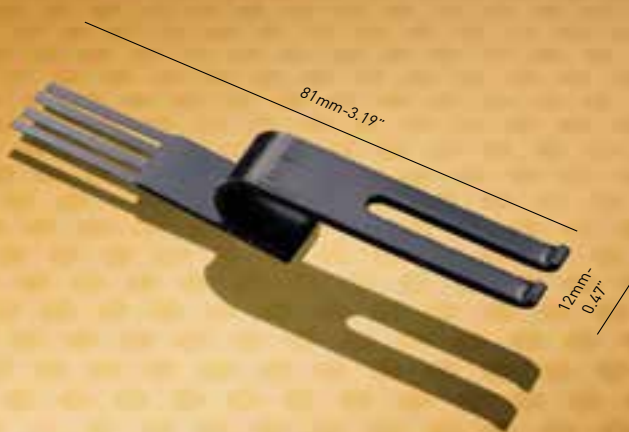

Code: SHEETB2 66.028.110F/01

Model: Speedmaster/S-Offset

Description: Blade with bent frame

Thickness: 0.2mm / 0.008"

Packing: 1 piece

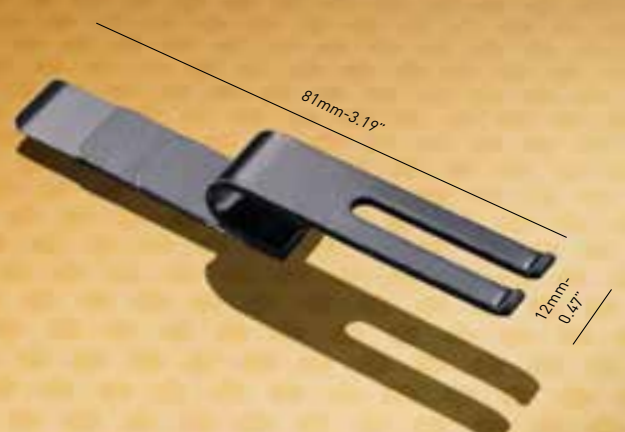

Code: SHEET105SM 62.028.130S/01

Model: SM52/SM102/CD102/XL105/XL106/
XL145/XL162

Description: Blade with bent frame

Thickness: 0.2mm / 0.008"

Packing: 1 piece



Code: SHEET105F

Model: SM52/SM102/CD102/XL105/XL106/
XL145/XL162

Description: Fork with bent frame

Thickness: 0.2mm / 0.008"

Packing: 1 piece



Code

SHEET74FS/Pair
SHEET74F1/1pc
SHEET74F2/1 pc

Model: SM74/PM74/CD74/XL75
Description: Sheet Separator
Thickness: 0.20mm/0.008"
Packing: 1 pair or 1 piece

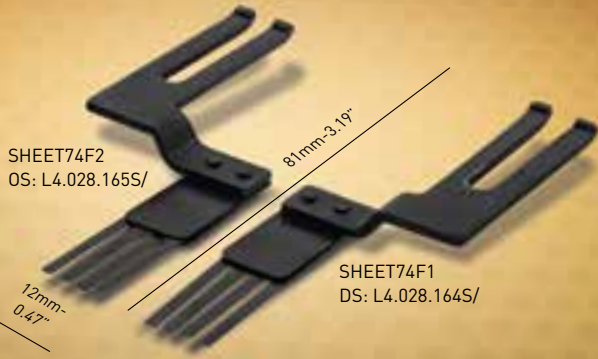

Code

SHEET74BS/Pair
SHEET74B1/1pc
SHEET74B2/1 pc

Model: SM74/PM74/CD74/XL75
Description: Sheet Separator
Thickness: 0.20mm/0.008"
Packing: 1 pair or 1 piece

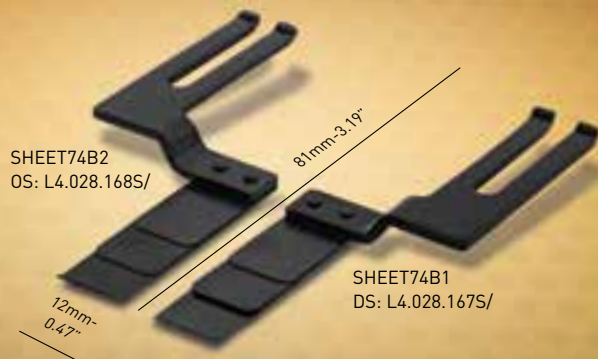

Code: SHEETCOMBIF M3.028.824S

Model: Speedmaster

Description: Combi sheet separator - Fork
Thickness: 0.2mm / 0.008"
Packing: 1 piece

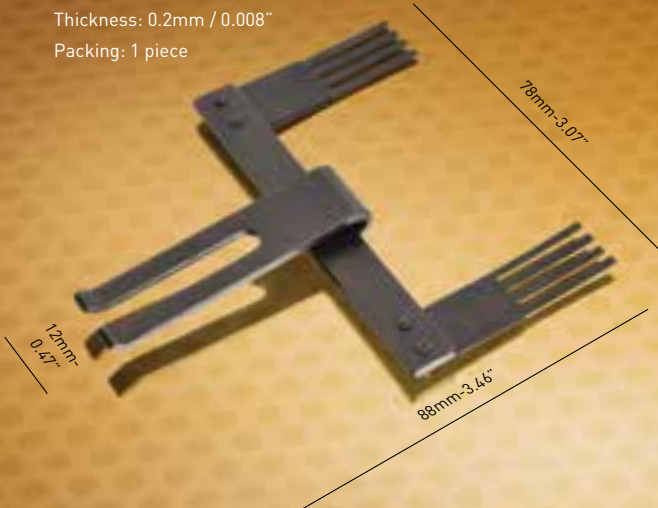

Code: SHEETCOMBIB

Model: Speedmaster

Description: Combi sheet separator - Blade
Thickness: 0.2mm / 0.008"
Packing: 1 piece

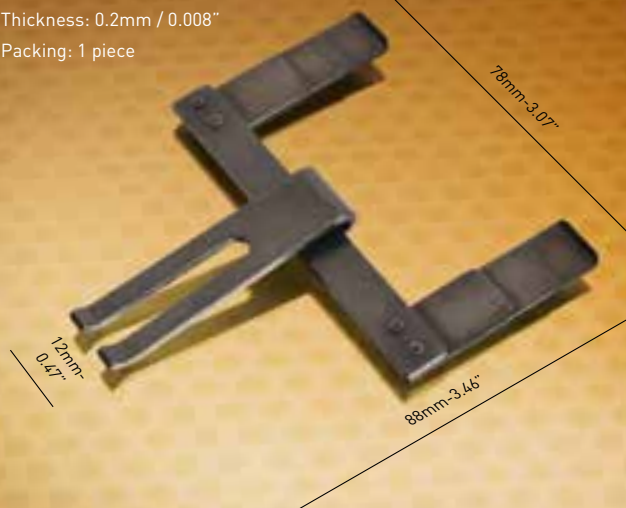

Code: SHEETCB7475 M3.028.825S/01

Model: CD74/XL75

Description: Combi Sheet Separator - Blade
Packing: 1 piece

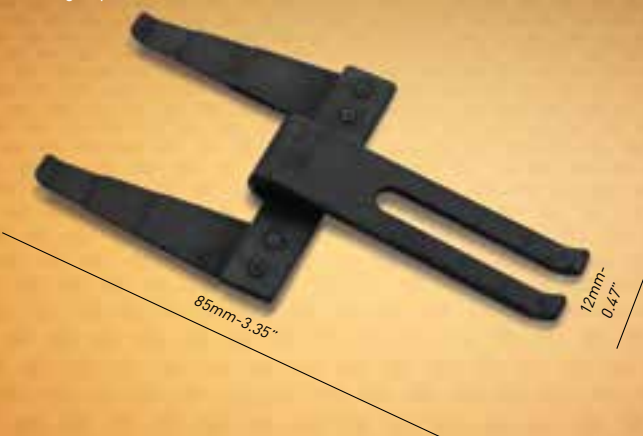

Code: SHEET52R 36.017.084

Model: GT052

Description: Standard with rubber hood
Thickness: 1.0mm / 0.039"
Packing: 1 piece

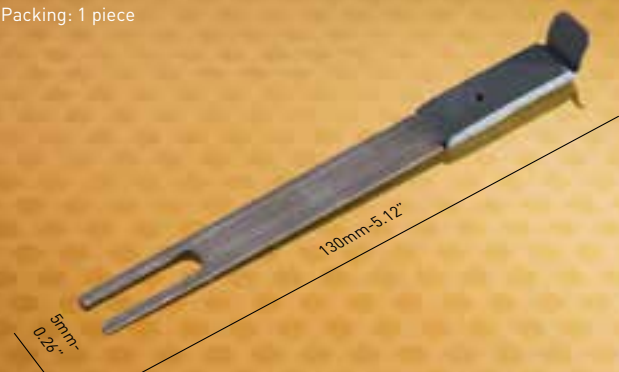

HEIDELBERG

Code: SHEET52

Model: GT052

Description: Standard sheet separator

Thickness: 1.0mm / 0.039"

Packing: 1 piece

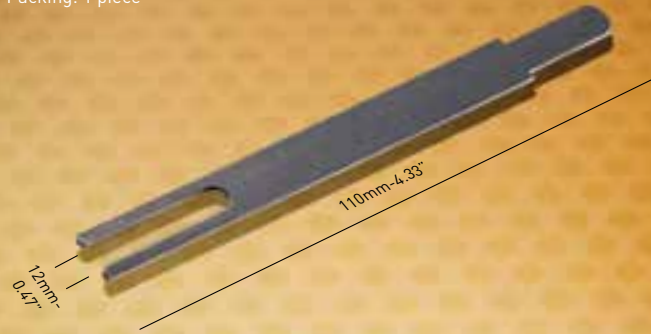

Code: SHEET46 42.017.083

Model: GT046

Description: Standard sheet separator

Thickness: 1.0mm / 0.039"

Packing: 1 piece



Code: SHEET46R 42.017.083F

Model: GT046

Description: Standard with rubber hood

Thickness: 1.0mm / 0.039"

Packing: 1 piece



Code: SHEET5245

Model: GT052/M0

Description: Sheet separator with 45°

Thickness: 0.3mm / 0.012"

Packing: 1 piece



Code: RHOODGTO 36.017.084

Model: GT046/GT052

Description: Rubber hood for sheet separator

Packing: 12 pcs/bag

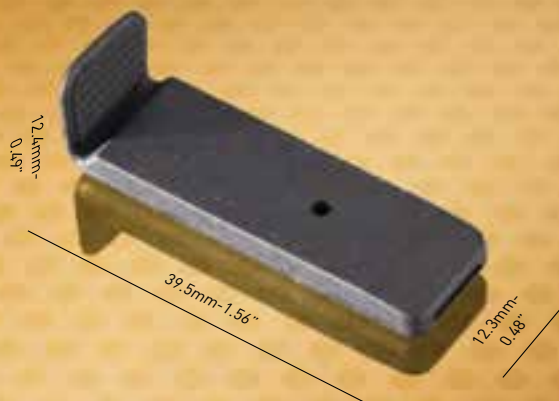

Code: SHEET6445 43.017.079

Model: KORD64/GT046

Description: Sheet separator with 45°

Thickness: 0.3mm / 0.012"

Packing: 1 piece



Code: SHEETKBA120

Model: KBA RAPIDA 104/105/142/162

Description: Steel sheet separator

Thickness: 0.2mm / 0.008"

Packing: 1 piece

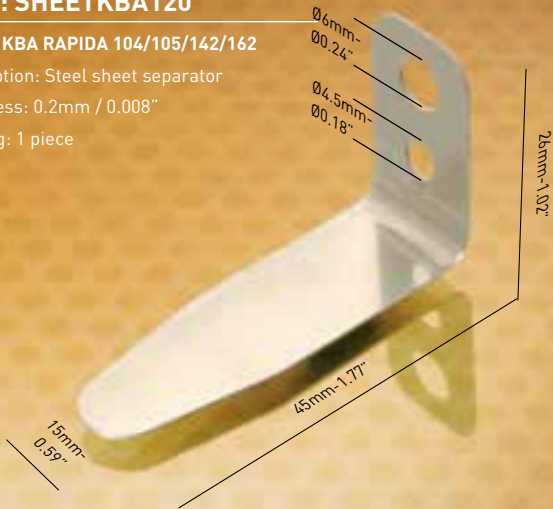

Code: SHEETKBA140

Model: KBA RAPIDA 104/105/142/162

Description: Steel sheet separator

Thickness: 0.4mm / 0.016"

Packing: 1 piece

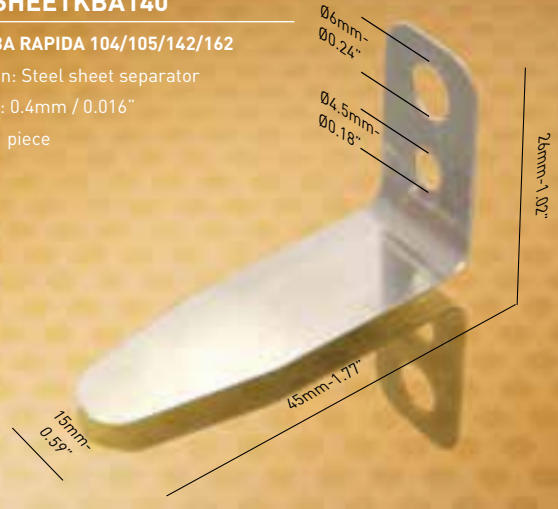

SHEETKBAPIN

Model: KBA RAPIDA 104/105/142/162

Description: Pin for mounting

- | | |
|-------------|-----------------|
| SHEETKBA104 | SHEETKBAC3 |
| SHEETKBA120 | SHEETKBAUNIC110 |
| SHEETKBAC1 | SHEETKBAUNIC120 |
| SHEETKABC2 | SHEETKBAUNIC130 |

Packing: 1 piece

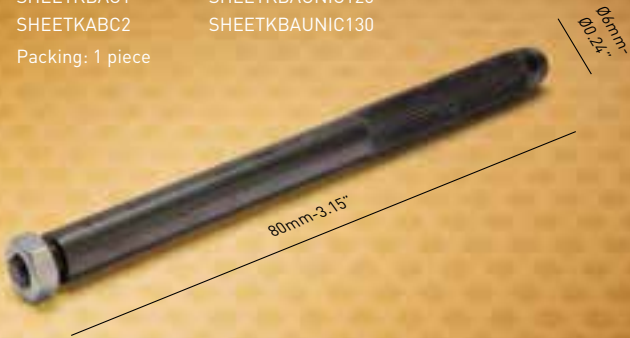

Code: SHEETKBAC1

Model: KBA RAPIDA 104/105/142/162

Description: Complete assembly

Thickness: 0.1mm / 0.004"

Packing: 1 piece



Code: SHEETKBAC2

Model: KBA RAPIDA 104/105/142/162

Description: Complete assembly

Thickness: 0.1mm / 0.004"

Packing: 1 piece

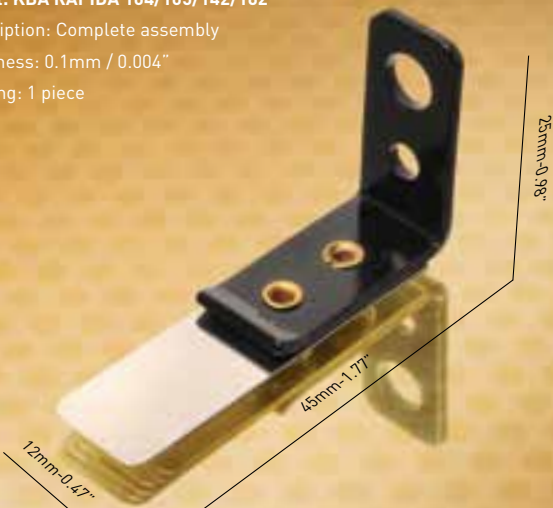

Code: SHEETKBAC3

Model: KBA RAPIDA 104/105/142/162

Description: Complete assembly

Thickness: 0.1mm / 0.004"

Packing: 1 piece

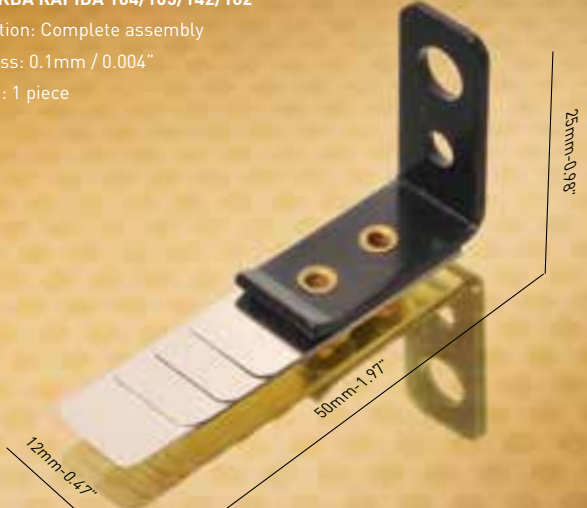

MITSUBISHI

| Code | Thickness (mm/inch) |
|-----------------|------------------------|
| SHEET401 | 0.10mm / 0.004" |
| SHEET402 | 0.20mm / 0.008" |
| SHEET403 | 0.30mm / 0.012" |

Model: Mitsubishi
 Description: Flat sheet separator
 Packing: 25 pcs/bag

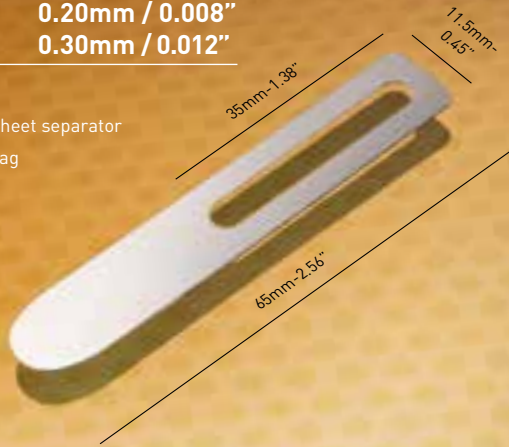

| Code | Thickness (mm/inch) |
|------------------|------------------------|
| SHEET5015 | 0.15mm / 0.006" |
| SHEET5020 | 0.20mm / 0.008" |

Model: Mitsubishi
 Description: Flat sheet separator
 Packing: 25 pcs/bag

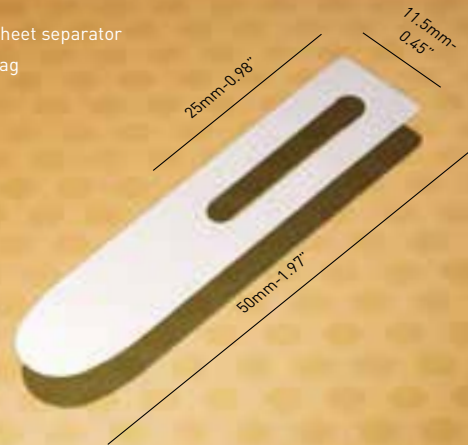

Code: SHEETB20

Model: Mitsubishi
 Description: Bent sheet separator
 Thickness: 0.15mm / 0.006"
 Packing: 12 pcs/bag

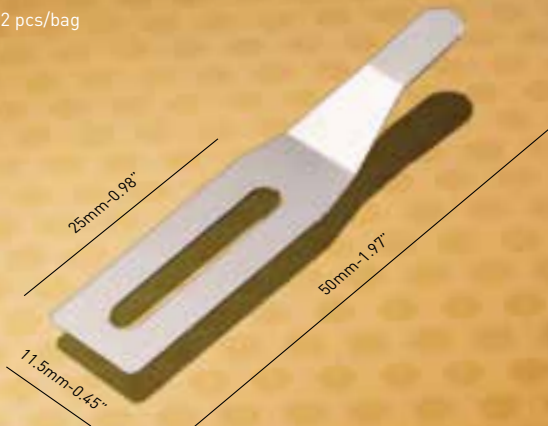

UNIVERSAL

Code: SHEETKBAUNI1

Model: KBA/MAN/PLANETA/ROLAND
 Description: Universal sheet separator complete assembly
 Thickness:
SHEETKBAUNI110
 0.10mm/0.004"
SHEETKBAUNI120
 0.20mm/0.008"
SHEETKBAUNI130
 0.30mm/0.012"
 Packing: 1 piece

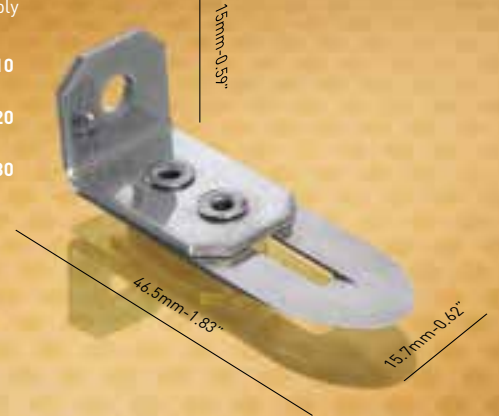

ROLAND

Code: SHEET700

Model: Roland 200/500/700/800/900
 Description: Flat sheet separators
 Length:
A - 37mm/1.46"
B - 38mm/1.50"
C - 39mm/1.54"
D - 40mm/1.57"
E - 41mm/1.61"
 Set composed of 5 sheet separators of different sizes
 Thickness: 0.10mm/0.004"
 Packing: 1 set/bag

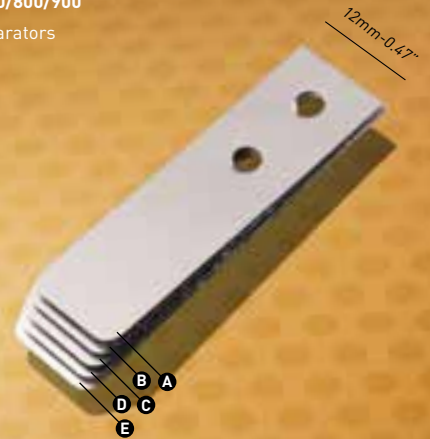

Code: SHEET900

Model: Roland 900
 Description: Bent sheet separator
 Thickness: 0.30mm / 0.012"
 Packing: 12 pcs/bag

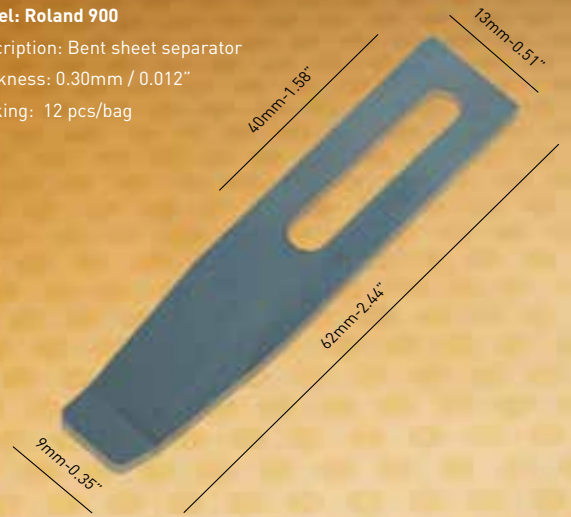

HEIDELBERG

FEEDER BRUSHES

Code: SHEETBR1 66.028.109F/

Model: SM72/74/102/S-Offset

Description: Feeder Brush

Packing: 1 piece



Code: SHEETBR3 A4.016.218/01

Model: Quickmaster 46 DI/Printmaster 46

Description: Feeder Brush

Packing: 1 piece

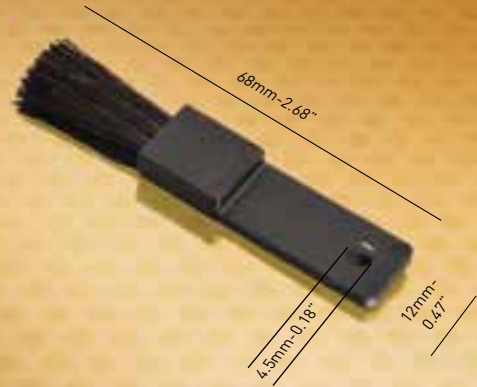

Code: SHEETBR2 04.022.069

Model: GTO/MO/S-Offset/SM52/72/102

Description: Feeder Brush

Packing: 1 piece



Code: SHEETBR2C 04.022.069F/02

Model: GTO/MO/S-Offset/SM52/72/102

Description: Feeder brush with clamp

Packing: 1 piece

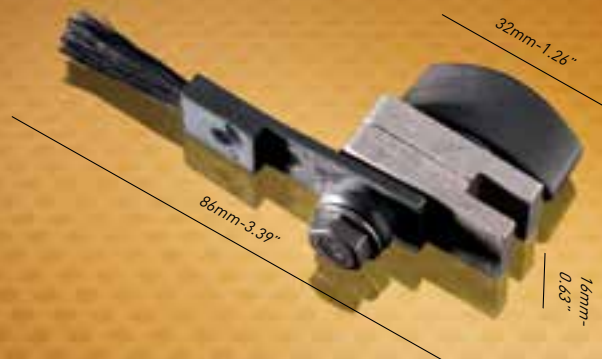

RYOBI - ITEK

Code: SHEET9015

Model: Ryobi/Itek

Description: Bent sheet separator

Thickness: 0.15mm / 0.006"

Packing: 12 pcs/bag

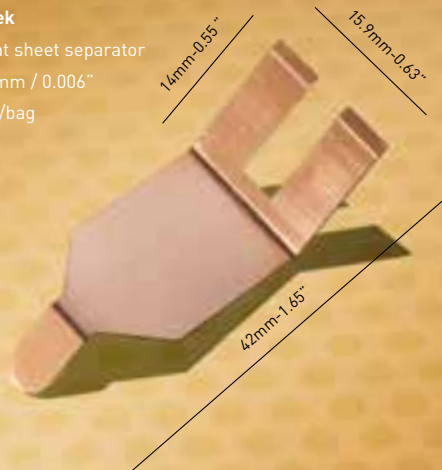

Code: SHEET7015

Model: Ryobi 520/680/750

Description: Flat sheet separator

Thickness: 0.15mm / 0.006"

Packing: 25 pcs/bag



KBA

Code: SHEETBRKBA1

Model: KBA Rapida 105/142/162

Description: Feeder brush

Packing: 1 piece

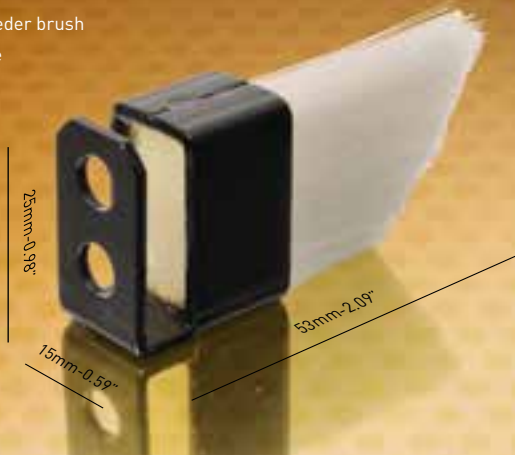

Code: SHEETBRKBA2

Model: KBA Rapida 105/142/162

Description: Feeder brush

Packing: 1 piece

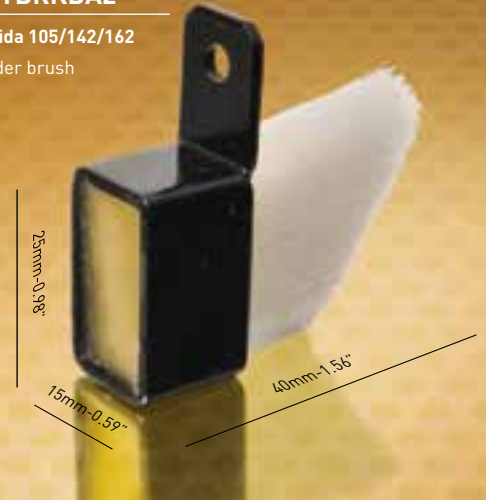

Code: SHEETBRKBA3

Model: KBA Rapida 105/142/162

Description: Feeder brush

Packing: 1 piece

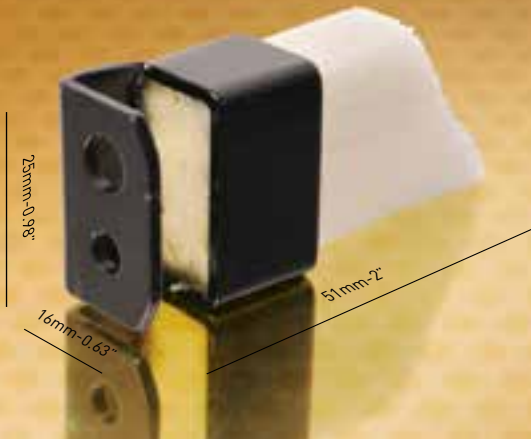

KOMORI

Code: SHEETBRK01 444-1665-005

Model: Komori 440/540/640/840

Description: Feeder brush

Packing: 1 piece

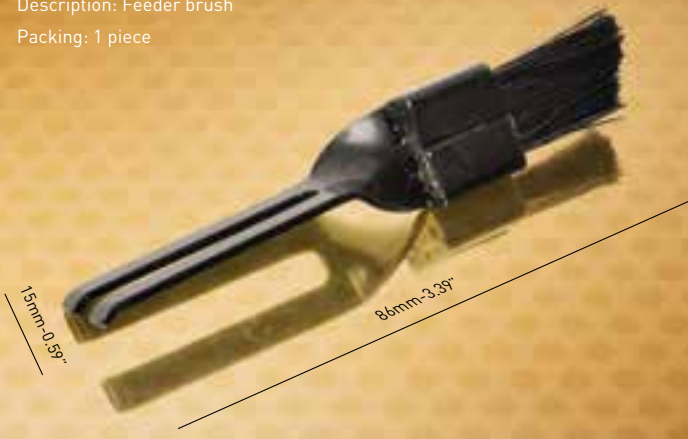

Code: SHEETBRK02

Model: All Komori models

Description: Feeder brush

Packing: 1 pair



ROLAND

Code: SHEETBR21

Model: M.A.N./Roland/Spies

Description: Feeder brush with holder cpl.

Packing: 1 piece

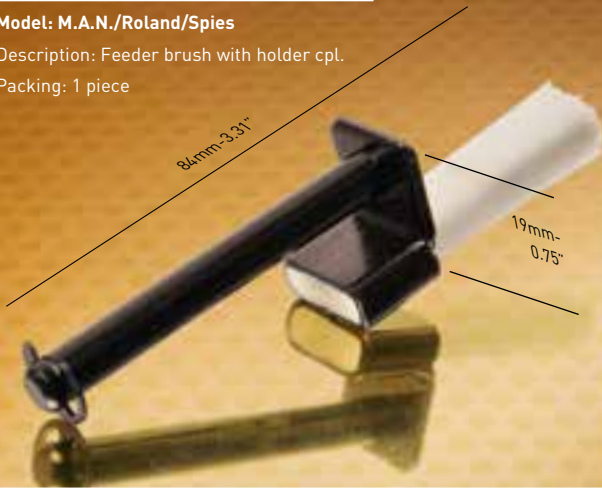

Code: SHEETBR22

Model: M.A.N./Roland/Spies

Description: Feeder brush

Packing: 1 piece

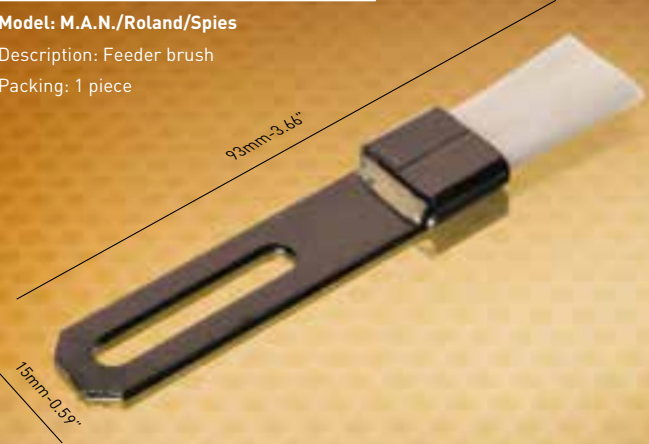

Code: SHEETBR23

Model: M.A.N./Roland/Spies

Description: Feeder brush

Packing: 1 piece

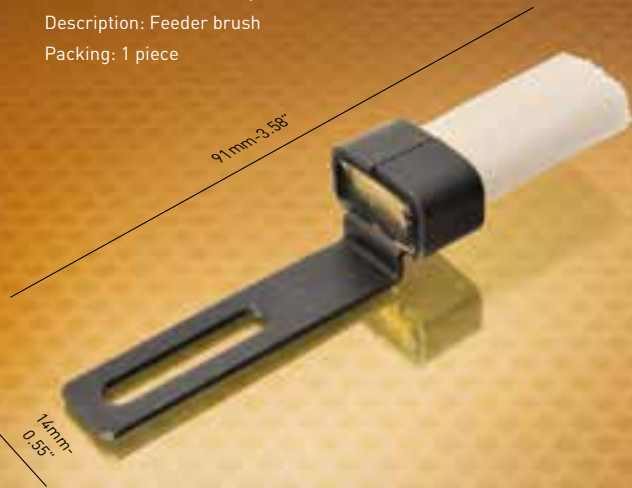

Code: SHEETBR24

(old code: SHEET800)

Model: M.A.N./Roland/Spies
(popular on Roland 800)

Description: Feeder brush

Packing: 1 piece

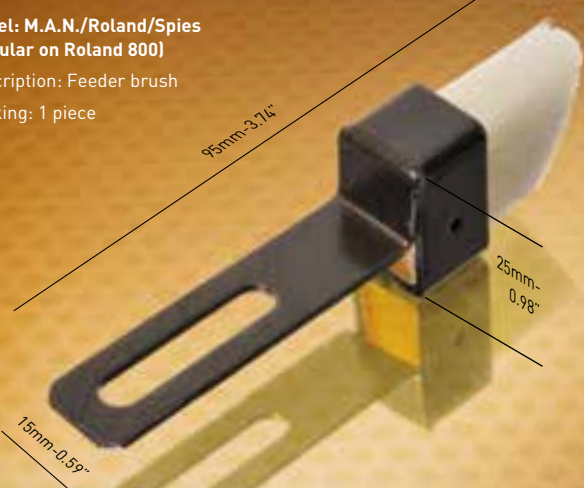

Code: SHEETBR25

Model: M.A.N./Roland/Spies

Description: Feeder brush

Packing: 1 piece

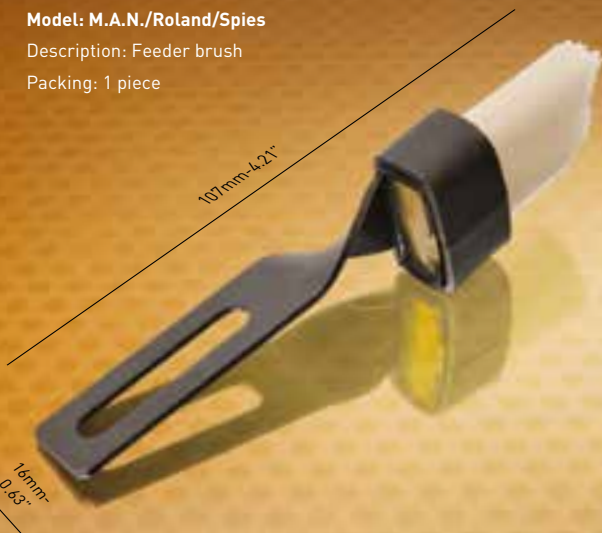

Parts for Heidelberg Platen T and GT are listed on pages 74 & 75

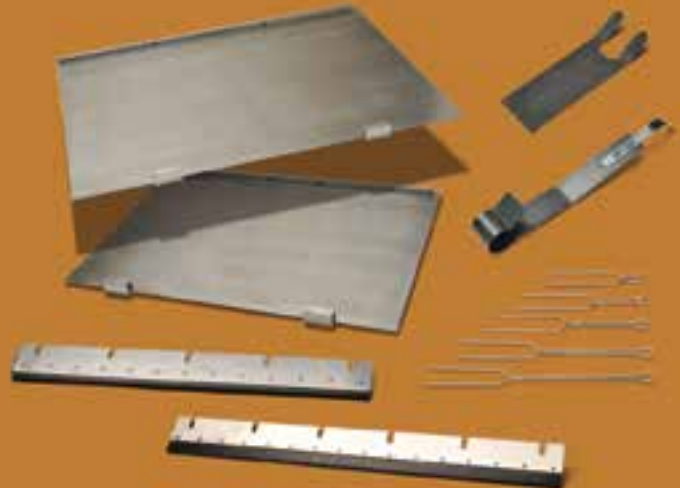

Brush Wheels and Rubber Wheels



BRUSH WHEELS

46

BRUSH WHEELS

AKIYAMA

Code: BWAKIYAMA01

Model: AKIYAMA

Description: Brush wheel

Packing: 1 piece

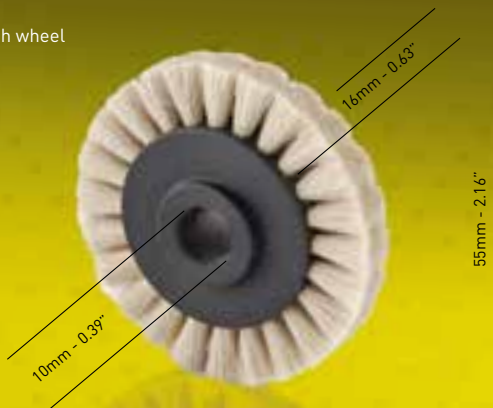

NIKKO

Code: BWNIKK01

Model: Nikko Diecutter

Description: Brush wheel

Packing: 1 piece





HEIDELBERG

Code: BWHEIWHITE

Model: Heidelberg SORM/SORD/SORS
SM52/72/74/102
Miller TP41S/TP104

Description: White brush wheel with soft bristles for paper

Packing: 1 piece

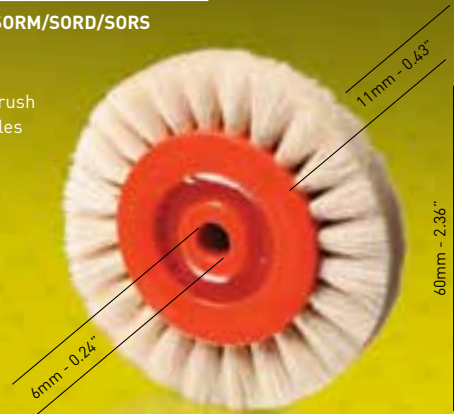

Code: BWHEIBLACK

Model: Heidelberg SORM/SORD/SORS
SM52/72/74/102
Miller TP41S/TP104

Description: Black brush wheel with harder bristles for cardboard

Packing: 1 piece



BOBST

Code: BWBOBST1

Model: BOBST

Description: Brush wheel

Packing: 1 piece



Code: BWBOBST2

Model: BOBST

Description: Brush wheel with aluminum core

Packing: 1 piece



KBA

Code: BWKBA1

Model: KBA RAPIDA 104/KBA 105

Description: Brush wheel – hard bristles complete with 2 bearings

Packing: 1 piece



Code: BWKBA9

Model: KBA RAPIDA 104/KBA 105

Description: Brush wheel – soft bristles complete with 2 bearings

Packing: 1 piece

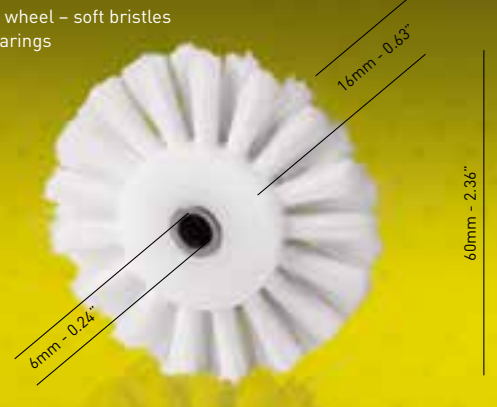

Code: BWKBA2

Model: KBA RAPIDA 104/KBA 105

Description: Brush wheel for cardboard complete with 2 bearings

Packing: 1 piece



Code: BWKBA8

Model: KBA RAPIDA 104/KBA 105

Description: Brush wheel for paper complete with 2 bearings

Packing: 1 piece

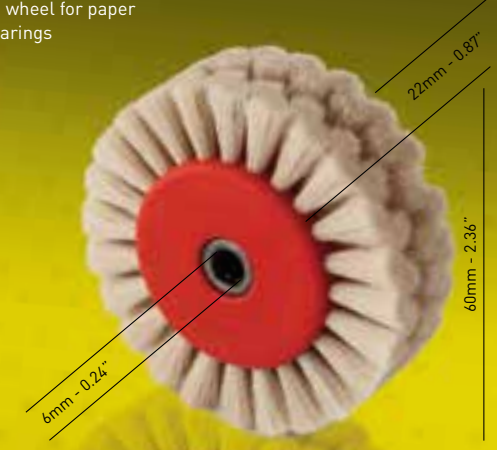

Code: BWKBA3

Model: KBA/Planeta

Description: Brush wheel for cardboard complete with 2 bearings

Packing: 1 piece



Code: BWKBA7

Model: KBA/Planeta

Description: Brush wheel for paper complete with 2 bearings

Packing: 1 piece

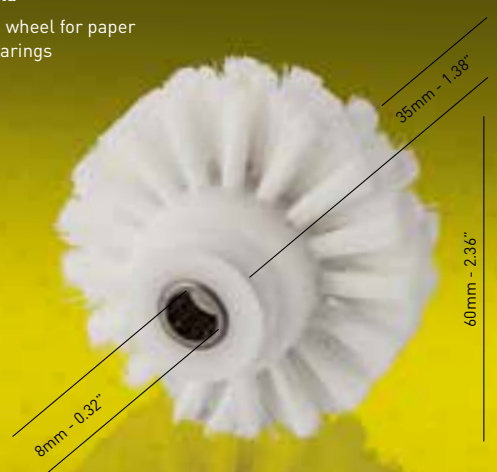

Code: BWKBA5

Model: KBA RAPIDA 142/162 (all models)

Description: Brush wheel for paper complete with 2 bearings

Packing: 1 piece



Code: BWKBA6

Model: KBA RAPIDA 142/162 (all models)

Description: Brush wheel for cardboard complete with 2 bearings

Packing: 1 piece

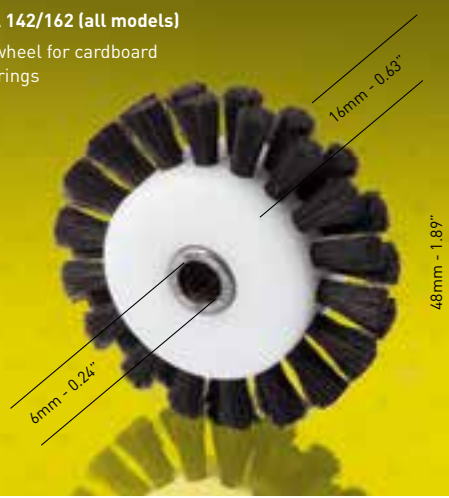

Code: BWKBA4

Model: KBA RAPIDA 105

Description: Brush wheel complete with bearing

Packing: 1 piece



SHINOHARA

Code: BWSHIN01

Model: Shinohara (all models)

Description: White brush wheel for paper

Packing: 1 piece



SAKURAI

Code: BWSAKU1

Model: Sakurai (all models)

Description: White brush wheel for paper

Packing: 1 piece

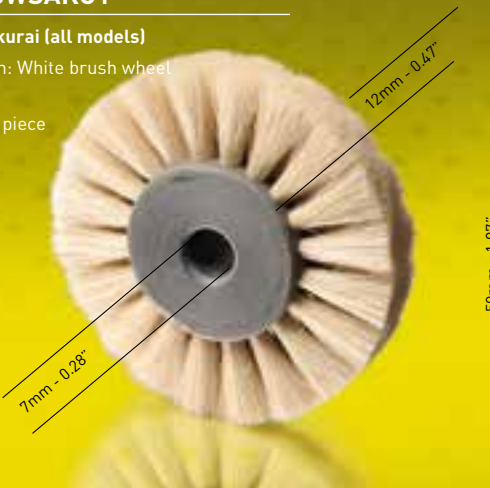

Code: BWSHIN02

Model: Shinohara (all models)

Description: White brush wheel for paper

Packing: 1 piece

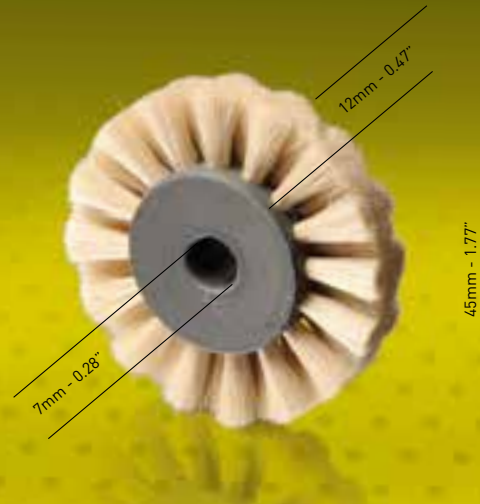

KOMORI

Code: BWKR1 4441341204

**Model: KOMORI (all models)
ROLAND/MABEG**

Description: White brush wheel for paper

Packing: 1 piece



Code: BWKR2 4441341304

**Model: KOMORI (all models)
ROLAND/MABEG**

Description: Black brush wheel for cardboard

Packing: 1 piece



Code: BWKR4 4441341124

**Model: KOMORI (all models)
ROLAND/MABEG**

Description: Black brush wheel for cardboard

Packing: 1 piece



Code: BWKR5

Model: KOMORI

Description: Black brush wheel - small

Packing: 1 piece



Code: BWKRWHITE

**Model: KOMORI (all models)
ROLAND 700/600/REKORD (all models)**

Description: White brush wheel for paper

Packing: 1 piece



Code: BWKRBLACK

**Model: KOMORI (all models)
ROLAND 700/600/REKORD (all models)**

Description: Black brush wheel for cardboard

Packing: 1 piece



MITSUBISHI

Code: BWMITWHITE

Model: Mitsubishi (all models)

Description: White brush wheel for paper

Packing: 1 piece

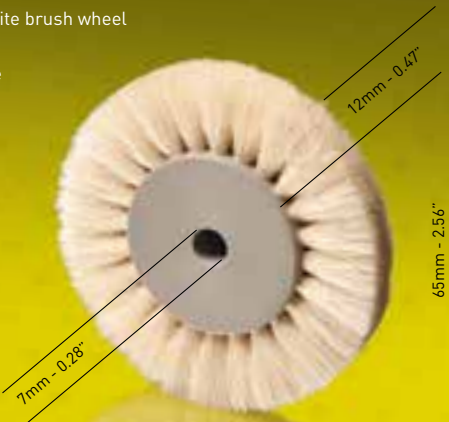

Code: BWMITBLACK

Model: Mitsubishi (all models)

Description: Black brush wheel for cardboard

Packing: 1 piece

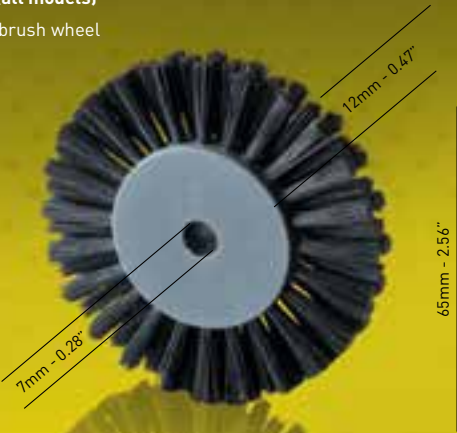

ROLAND

Code: BWKR1

Model: ROLAND (all models)
KOMORI (all models)

Description: White brush wheel for paper

Packing: 1 piece

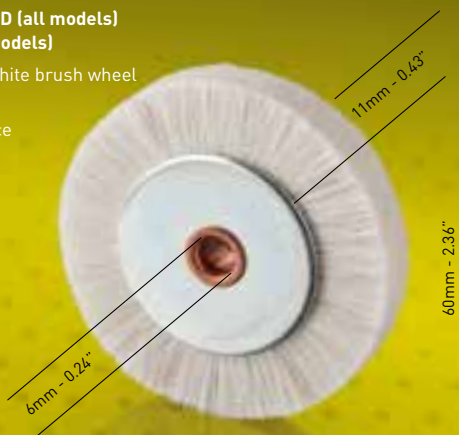

Code: BWKR2

Model: ROLAND (all models)
KOMORI (all models)

Description: Black brush wheel for cardboard

Packing: 1 piece



Code: BWKR3

Model: ROLAND (all models)
KOMORI/MABEG

Description: White brush wheel for paper

Packing: 1 piece



Code: BWKR4

Model: ROLAND (all models)
KOMORI/MABEG

Description: Black brush wheel for cardboard

Packing: 1 piece



RYOBI

Code: BWRYOBI01

Model: RYOBI

Description: White brush wheel for paper

Packing: 1 piece



Code: BWRYOBI02

Model: RYOBI

Description: White brush wheel for paper

Packing: 1 piece



Code: BWRYOBI03

Model: RYOBI

Description: Black brush wheel for cardboard

Packing: 1 piece



Code: BWRYOBI04

Model: RYOBI

Description: White brush wheel for paper

Packing: 1 piece



BRUSH WHEELS

52

Blanket repair, plate deletion gels and plate correction pens can all be found on page 129



Code: POSGEL



Code: RBR250

RUBBER WHEELS - HEIDELBERG

Code: RWHEIS

Model: Heidelberg SORM/SORD/SORS/
SM52/72/74/102

Description: Soft rubber wheel for feeder

Packing: 1 piece



Code: RWHEIH

Model: Heidelberg SORM/SORD/SORS/
SM52/72/74/102

Description: Hard rubber wheel for feeder

Packing: 1 piece

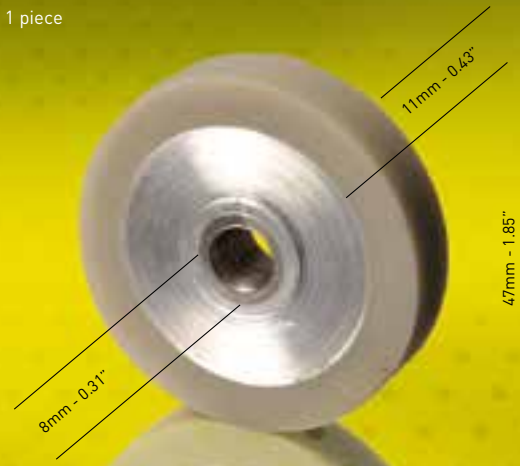

Code: RWHEI1 89016236 HARD

Model: Heidelberg SM52

Description: Hard rubber wheel for feeder

Packing: 1 piece



Code: RWHEI2 89016236 SOFT

Model: Heidelberg SM52

Description: Soft rubber wheel for feeder

Packing: 1 piece



Code: RWHEI6 F4.614.555F

Model: Heidelberg CD74/XL75/SM102/
SX102/CX102/
CD102/XL105/XL106/XL145/XL162

Description: Friction wheel for sheet breaking

Packing: 1 piece



Find the new Universal Seal for
Tresu D2 chambers



and our new Steel and Brass Brushes
for cleaning anilox rollers on page 61



KBA

Code: RWKBA1

Model: KBA SRO 72/KBA RAPIDA 72/74

Description: Soft rubber wheel with bearing

Packing: 1 piece

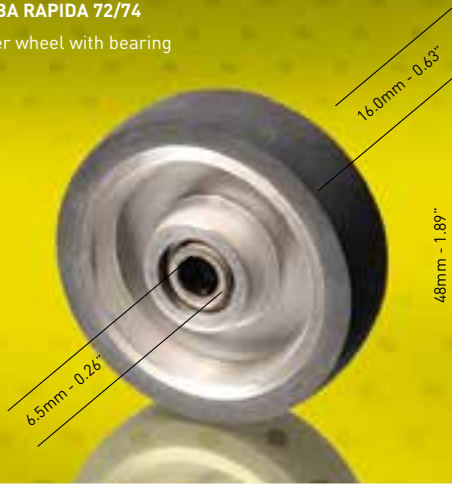

Code: RWKBA2

Model: KBA RAPIDA 104/142/162 (all models)
Miller TP41S/TP104

Description: Soft rubber wheel

Packing: 1 piece

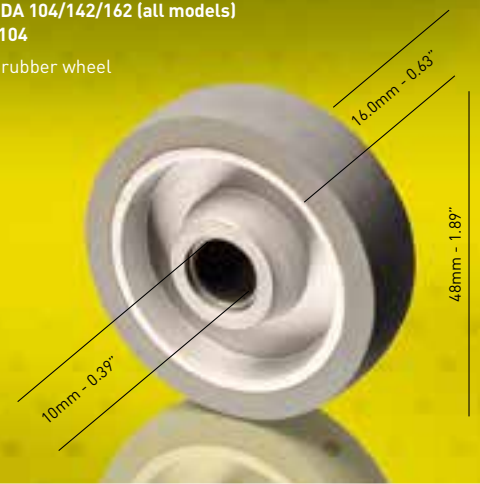

Code: RWKBA3

Model: KBA RAPIDA 104/KBA 105

Description: Rubber wheel with bearing

Packing: 1 piece



Code: RWKBA4

Model: RAPIDA 142/KBA 162 (all models)

Description: Rubber wheel with bearing

Packing: 1 piece



Code: RWKBA5

Model: KBA

Description: Rubber wheel for feeder

Packing: 1 piece

Also ask for:
Code: RWKBASP1
Spindle for RWKBA5
and RWKBA6

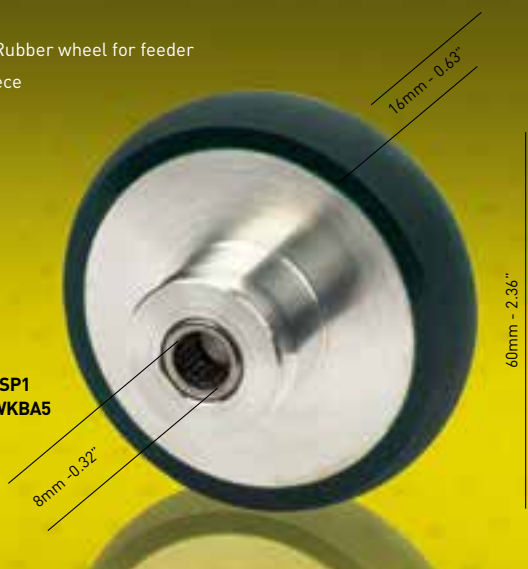

Code: RWKBA6

Model: KBA

Description: Rubber wheel for feeder

Packing: 1 piece

Also ask for:
Code: RWKBASP1
Spindle for RWKBA5
and RWKBA6



BOBST

Code: RWBOBST21

Model: Bobst

Description: Rubber wheel for feeder
Packing: 1 piece



Code: RWBOBST22

Model: Bobst

Description: Rubber wheel for feeder
Packing: 1 piece



Code: RWK01

Model: Komori

Description: Rubber wheel for feeder
Packing: 1 piece



Code: RWK02

Model: Komori

Description: Rubber wheel for feeder
Packing: 1 piece

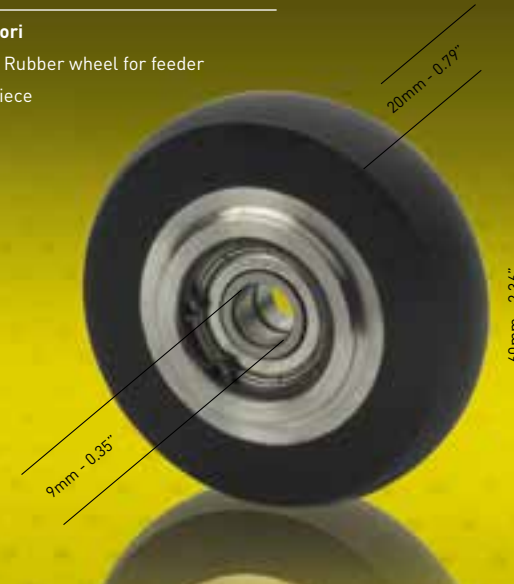

ROLAND

Code: RWR1

Model: Roland

Description: Rubber wheel with bearing
Packing: 1 piece



Grippers and Gripper Pads on page 78



Hickey Removers

HICKEY REMOVERS

56

HICKEY REMOVERS

Master hickey removers are designed and manufactured to original specifications. We use the highest quality raw materials including corrosion-proof steel and chemical resistant rubber. The molded rubber tips are chemically bonded to the steel preventing separation.

Code: HR52

Model: Heidelberg SM52

Description: Hickey remover complete

Packing: 1 piece



HEIDELBERG

Code: HR102CPL

Model: Heidelberg SM72/SM102 with Alcolor

Description: Hickey remover complete

Packing: 1 piece



Code: HR102

Model: SM102 Hickey remover

Description: Replacement rubber

Packing: 5 pcs



Code: HRSOM0

Model: Heidelberg M0/S-Offset/SM72

Description: Hickey remover complete

Packing: 1 piece



Code: HR105

Model: Heidelberg XL105

Description: Hickey remover complete

Packing: 1 piece



Code: HR74

Model: Heidelberg SM74/PM74

Description: Hickey remover complete

Packing: 1 piece

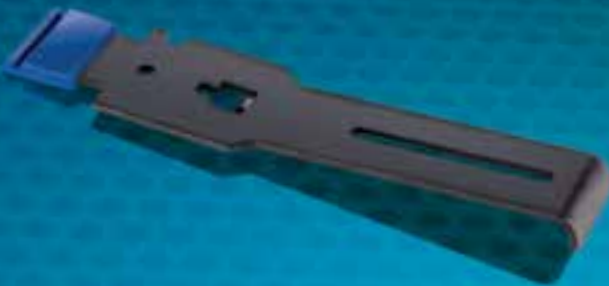

Code: HRCD74 L2.032.003S

Model: Heidelberg CD74

Description: Hickey remover complete

Packing: 1 piece



KBA

Code: HRKBA1

Model: KBA Rapida 142/162

Description: Hickey remover

Size: 46 x 30mm/1.81 x 1.18"

Packing: 1 piece



Code: HRKBA2

Model: KBA Rapida 142/162

Description: Hickey remover

Size: 50 x 30mm/1.97 x 1.18"

Packing: 1 piece



Code: HRKBA3 (old code: HRKBA104)

Model: KBA Rapida 104/105

Description: Hickey remover

Width: 40mm/1.57"

Packing: 1 piece



Code: HRKBA4

Model: KBA Rapida 104/105

Description: Hickey remover

Width: 30mm/1.18"

Packing: 1 piece



Code: HRKBA5

Model: KBA Rapida 75

Description: Hickey remover

Size: 40mm/1.57"

Packing: 1 piece



Code: HRFS1

Model: Fuji-Shinohara 52

Description: Hickey remover

Size: 38 x 22mm/1.50 x 0.87"

Packing: 1 piece



FUJI-SHINOHARA

MITSUBISHI

Code: HRMIT1F

Model: Mitsubishi 1E/1F/Diamond

Description: Hickey remover

Size: 30 x 46 x 5mm/1.18 x 1.81 x 0.20"

Packing: 1 piece



KOMORI

Code: HRK01

Model: Komori Lithrone 40/440/540/640/840

Description: Hickey remover

Size: 52 x 29mm/2.05 x 1.14"

Packing: 1 piece



Code: HRMIT3F

Model: Mitsubishi 3F/Diamond

Description: Hickey remover

Size: 39 x 45 x 5mm/1.54 x 1.77 x 0.20"

Packing: 1 piece



ROLAND

Code: HRR3B

Model: 600/REKORD 3B/Parva/Favorit/OB/200

Description: Hickey remover

Size: 22 x 16 x 5mm/0.87 x 0.63 x 0.20"

Packing: 5 pcs

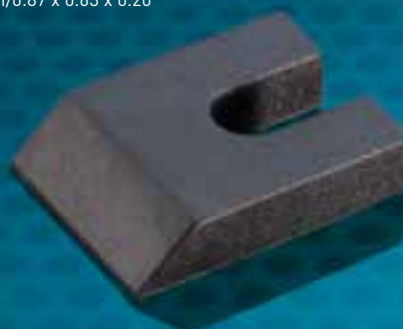

Code: HRR300

Model: Roland 300

Description: Hickey remover

Size: 28 x 28 x 3mm/1.10 x 1.10 x 0.12"

Packing: 5 pcs



Code: HRR800

Model: Roland 800

Description: Hickey remover

Size: 76 x 34 x 3mm/2.99 x 1.34 x 0.12"

Packing: 5 pcs

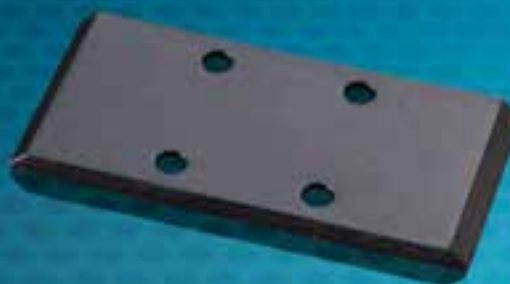

MASTER PACK

UNDERLAY PACKING PAPER

Top quality calibrated non-slip underlay packing paper for accurate adjustment of plate and blanked packing.

Pre-treated against solvent and moisture

- Color coded for easy selection of thickness
- Uniform calibration across the sheet
- Excellent sheet density
- Pre-treated against moisture
- Suitable for all presses
- Available in many pre-cut sizes

0.05mm/0.020"

0.10mm/0.004"

0.125mm/0.005"

0.15mm/0.006"

0.175mm/0.007"

0.20mm/0.008"

0.25mm/0.010"

0.30mm/0.012"

0.40mm/0.016"

0.50mm/0.020"



MASTER[®] DOCTOR BLADES

FOR SHEET-FED OFFSET PRESSES

High quality, anti-corrosive stainless steel doctor blades. Excellent for all coating applications.

- Anti-corrosive
- Excellent for water-based inks, coatings and other products with high pH values
- Superior service life compared to standard blades

| Code | Width x Thickness | Length of Roll | Coating Unit Type |
|------------|-------------------|----------------|-------------------|
| DSS2520100 | 25mm x 0.20mm | 100M/Roll | Harris & Bruno |
| DSS2820100 | 28mm x 0.20mm | 100M/Roll | Harris & Bruno |
| DSS3220100 | 32mm x 0.20mm | 100M/Roll | Harris & Bruno |
| DSS3520100 | 35mm x 0.20mm | 100M/Roll | TRESU |

Also supplied in pre-cut lengths for all press models.

Made from high quality German steel with extreme tensile strength.

The hardness and uniform material structure guarantee a high wear resistance and a long service life.

Manufactured with a thin lamella profile on the front edge of the blade giving outstanding doctoring from the very first sheet.

ACCESSORIES

Code: TLBCUT

Description: Doctor blade cutting tool

Packing: 1 piece



Code: BRUSHSTEEL

Description: Steel Brush for cleaning ceramic anilox rollers

Size: 110 x 60mm - 4 21/64" x 2 23/64"
Packing: 1 pc/box



Code: BRUSHBRASS

Description: Brass Brush for cleaning chrome anilox rollers

Size: 110 x 60mm - 4 21/64" x 2 23/64"
Packing: 1 pc/box



UNIVERSAL SEAL FOR TRESU D2

Code: TSEALUNID2 C6.043.252 / 4002628

Model: SM52/SM72/SM74/CD74/XL75
SM102/CD102/XL105

Description: Universal Coater Seal for Tresu D2 Chamber

Size: 72x24mm

Packing: 50 pcs/pack



KBA

Code: TABKBA1

Model: KBA 142/162

Description: Tab for sheet pick-up

Thickness: TABKBA1A 0.30mm/0.012"
TABKBA1B 0.10mm/0.004"

Packing: 1 set

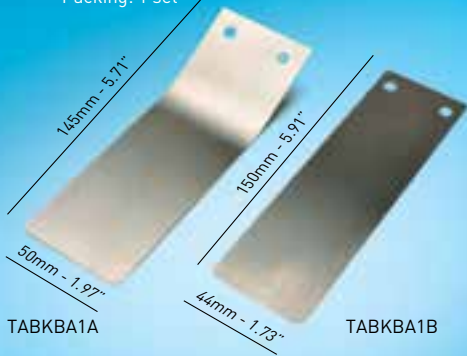

Code: TABKBA2

Model: KBA 104

Description: Tab for delivery table

Thickness: 0.20mm/0.008"

Packing: 1 piece

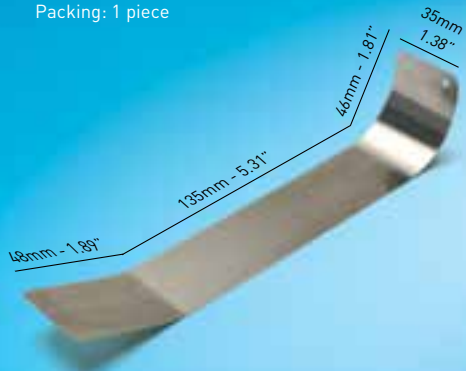

Code: TABKBA3

Model: KBA Rapida 142/162

Description: Tab for delivery table

Thickness: 0.50mm/0.02"

Packing: 1 piece

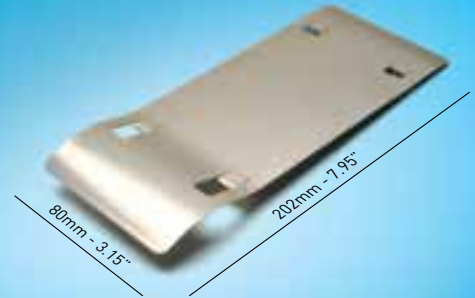

Code: KBASEAL290 P1660290

Model: KBA 105/106

Description: Sealing segment

Packing: 2 pcs/bag



Code: IBKBA105

Model: KBA 105

Description: Ink duct end blocks

Packing: 1 pair



Code: RSKBA20

Model: KBA

Description: KBA (Strecksauger)

Sucker for perfecting cylinders

Packing: 16 pcs/bag



MITSUBISHI

INK KEY COVER

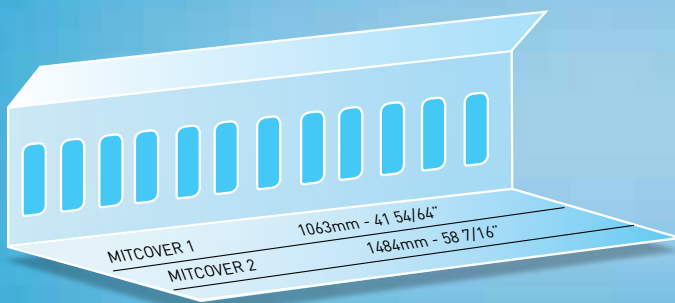

Code: MITCOVER1 KGV6579G

Model: Mitsubishi Diamond 3000

Description: Ink key cover for ink duct

Length: 1063 mm / 41 54/64"

Packing: 1 piece/10 pcs/box

Code: MITCOVER2

Model: Mitsubishi

Description: Ink key cover for ink duct

Length: 1484 mm / 58 7/16"

Packing: 1 piece/10 pcs/box

Code: MITKG08240

Model: Mitsubishi
1E/1F/1G/3E/3F/3G

Description: Servo motor for ink key

Packing: 1 piece



Code: GSMIT1

Model: Mitsubishi

Description: Sheet Guide

Packing: 1 piece



KOMORI

Code: GSK1 364-6800-400

Model: Komori

Description: Sheet guide

Width: 38mm/1.49"

Packing: 1 piece



Code: GSK2 274-6823-301

Model: Komori

Description: Sheet guide

Width: 90mm/3.54"

Packing: 1 piece

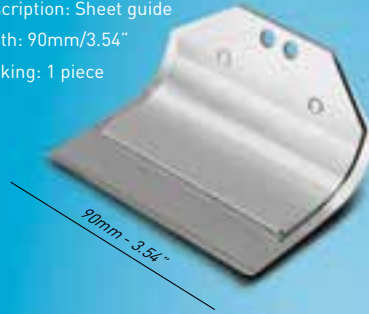

Code: KPHS

Model: Komori

Description: Plate hanger sucker

Packing: 10 pcs/bag



Code: GSK3

Model: Komori

Description: Sheet guide

Width: 38mm/1.49"

Packing: 1 piece



Code: GSK4 274-6821-301

Model: Komori

Description: Sheet guide

Width: 122mm/4.80"

Packing: 1 piece



Code: FGY3131034

Model: Komori

Description: Braking wheel for Auto Plate loader

Packing: 1 piece - 24pcs/box



Code: GSK5 FME6810501

Model: Komori

Description: Sheet guide

Width: 110mm/4.33"

Packing: 1 piece

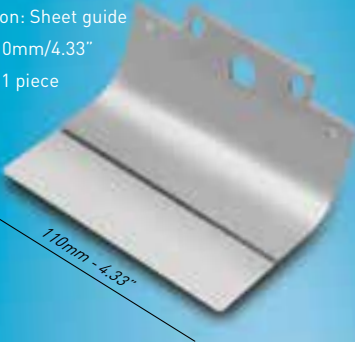

Code: GSK6 FME6810401

Model: Komori

Description: Sheet guide

Width: 195mm/7.68"

Packing: 1 piece

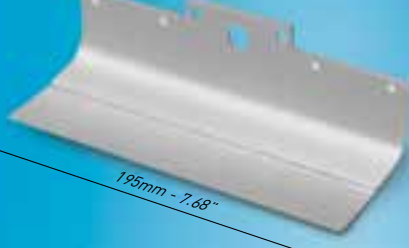

Code: TLC178181 261.9700.402

Model: Komori

Description: Combination wrench

Size: 17mm x Ø8mm x L181mm

Packing: 1 piece



Code: GSK7

Model: Komori

Description: Sheet guide

Width: W30mm x L180mm

Packing: 1 piece

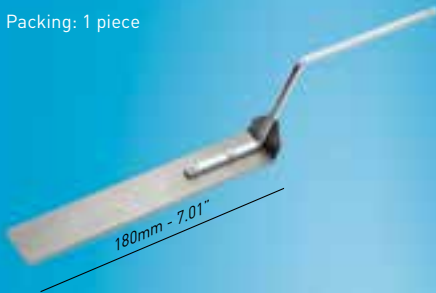

Code: GSK8

Model: Komori

Description: Sheet guide

Width: W50mm x L200mm

Packing: 1 piece



Code: OILFILTK01 3Z0-2601-140

Model: Komori

Description: Oil filter for Komori

Packing: 1 piece



GOSS - SHEET GUIDES

Code: WEBGS1

Model: Goss M600

Description: Small sheet guide

Packing: 3 pcs/bag



Code: WEBGS2

Model: Goss M600

Description: Large sheet guide

Packing: 3 pcs/bag



Code: WEBGS11

Model: Goss

Description: Flat sheet guide

Packing: 10 pcs/bag



Code: WEBGS3

Model: Goss S2000

Description: Small sheet guide

Packing: 3 pcs/bag

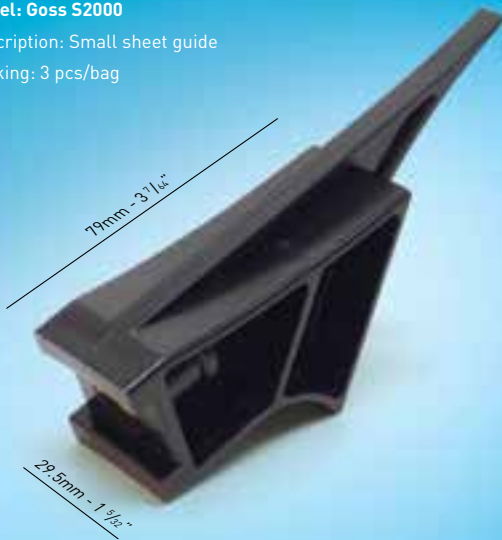

Code: WEBGS4

Model: Goss S2000

Description: Large sheet guide

Packing: 3 pcs/bag



Code: WEBGS5

Model: Goss

Description: Small sheet guide

Packing: 3 pcs/bag



Code: WEBGS6

Model: Goss

Description: Large sheet guide

Packing: 3 pcs/bag



HEIDELBERG - LIFTING SUCKERS

Code: LSUCK01 C4.028.009/02

Model: SM102/M0/SORS/SORD/SORM

Description: Lifting sucker

Packing: 1 piece



Code: LSUCK02 66.028.009/01

Model: SM102/M0/SORS/SORD/SORM

Description: Lifting sucker

Packing: 1 piece



Code: LSUCK03 F2.028.280S/01

Model: SM102/CD102

Description: Lifting sucker

Packing: 1 piece



Code: LSUCK04 F2.028.267S/01

Model: SM102/CD102

Description: Lifting sucker

Packing: 1 piece

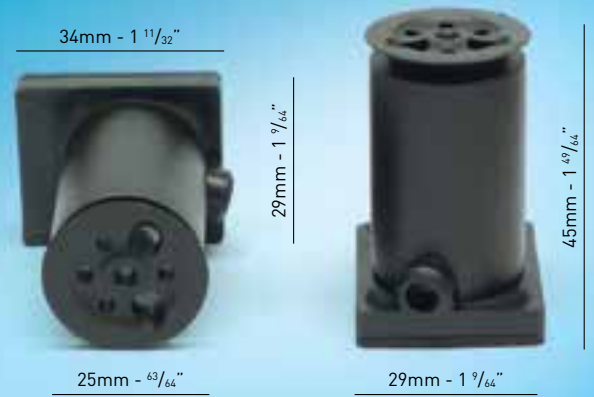

Code: LSUCK05 66.028.809/01

Model: SM102/CD102

Description: Lifting sucker

Packing: 1 piece



Code: LSUCK06 66.028.409/

Model: SM102/CD102

Description: Lifting sucker

Packing: 1 piece



HEIDELBERG - LIFTING SUCKERS

Code: LSUCK07

G2.028.0105

Model: SM52

Description: Lifting sucker

Packing: 1 piece



26mm - 1 1/32"

24mm - 15/16"

Code: LSUCK08

G2.028.010N

Model: SM52

Description: Lifting sucker with magnet

Packing: 1 piece

Code: LSUCK09 MV.056.999/01

Model: CD74/XL75

Description: Lifting sucker

Packing: 1 piece



24mm - 15/16"



77mm - 3 1/32"

35mm - 1 3/8"

Code: LSUCK10 MV.056.997/01

Model: CD74/XL75

Description: Lifting sucker- angled

Packing: 1 piece



24mm - 15/16"



80mm - 3 5/32"

35mm - 1 3/8"

ROLAND - LIFTING SUCKERS

Code: LSUCKMA01

Model: Mabeg

Description: Lifting sucker - paper

Packing: 1 piece



24mm
- 61/64"



47mm - 1 27/32"

49mm - 1 15/16"

Code: LSUCKMA02

Model: Mabeg

Description: Lifting sucker - cardboard

Packing: 1 piece



24mm
- 61/64"



47mm - 1 27/32"

49mm - 1 15/16"

Code: LSUCKMA03

Model: Roland 700

Description: Lifting sucker

Packing: 1 piece



22mm
- 55/64"



45mm - 1 49/64"

40mm - 1 37/64"

Complete unit with metal holder available

KBA - LIFTING SUCKERS

Code: LSUCKKBA01

Model: KBA 75

Description: Lifting sucker

Packing: 1 piece



23mm
- 29/32"



51mm - 2 1/64"

Code: LSUCKKBA02

Model: KBA 105/106

Description: Lifting sucker

Packing: 1 piece



23mm
- 29/32"



71mm - 2 51/64"

KOMORI

Code: LSUCKK01

Model: Komori GL40

Description: Lifting sucker

Packing: 1 piece



25mm
- 63/64"



53mm - 2 3/32"

BLANKET WASH PROFILE RUBBER

Code: RBWH10

Model: SM52/SM74/CD74/XL75/
XL105/XL106

Description: Blanket Wash Profile
Size: 10M
Packing: 10M roll/box

Code: RBWH105106 F2.205.089/03

Model: XL105/XL106
Description: Blanket Wash Profile
Size: 1070mm
Packing: 2 pcs/pack

Code: RBWH7475 F2.205.029/03

Model: SM74/CD74/XL75
Description: Blanket Wash Profile
Size: 770mm
Packing: 2 pcs/pack

Code: RBWH52

Model: SM52
Description: Blanket Wash Profile
Size: 560mm
Packing: 2 pcs/pack



HEIDELBERG - COATER BLADES

Code: COATLOS C4.721.075 O/S

Model: SM102
Description: Coater blade - large - operator side
Packing: 1 piece



Code: COATSDS C4.721.091 D/S

Model: SM102
Description: Coater blade - small - drive side
Packing: 1 piece



Code: COATLDS C4.721.074 D/S

Model: SM102
Description: Coater blade - large - drive side
Packing: 1 piece

Code: COATSOS C4.721.092 O/S

Model: SM102
Description: Coater blade - small - operator side
Packing: 1 piece



**ADHESIVE
UNDERLAY FOIL**

HEIDELBERG - CPC BUTTONS

Code: CPCBUTSQR 81.186.3855/02

Model: CPC button - square - 4 prong

Description: For CPC console

Packing: 1 piece



Code: CPCBUTREC 81.186.3815

Model: CPC button - rectangular - 4 prong

Description: For CPC console

Packing: 1 piece



CPC SERVO MOTOR

Code: VUER5311 12V 61.186.5311/03

Model: PM52/SM52/SM72/SM74/CD74/SM102/CD102 and some M0 with CPC

Description: These servo motors control the ink zones in each printing unit on presses equipped with CPC

Packing: 1 piece/box - 10 boxes/carton



FESTO VALVE

Code: M21841111 M2.184.1111

Model: Heidelberg presses

Description: Festo solenoid 4/2 way valve

Packing: 1 piece



SERVO DRIVES

Code: VUER1141 61.144.1141/01

Description: Servo-drive for PM-SM74/SM102/All CD/CS/SX/XL

Packing: 1 piece



Code: VUER1311 71.112.1311/03

Description: Servo-drive 98/536 [60 C] for PM-SM74/SM102/All CD/CS/SX/XL

Packing: 1 piece



PERFORATING RULES

HEIDELBERG - PLATE SPRINGS

Code: HSHP1 C4.372.338

Model: SM102/SM74/SM72/S-Offset

Description: Plate spring for sheet smoother

Thickness: 0.3mm/0.012"

Packing: 1 piece



Code: HSHP2

Model: SM102/SM74/SM72/S-Offset

Description: Adhesive separator for small plate spring

Packing: 1 piece



Code: HSHP4 42.022.038

Model: Heidelberg GTO

Description: Plate spring for GTO sheet smoother

Thickness: 0.3mm/0.012"

Packing: 1 piece



Code: HSHP3

Model: Heidelberg GT046/52

Description: GTO guide strap holding spring clip

Packing: 1 piece

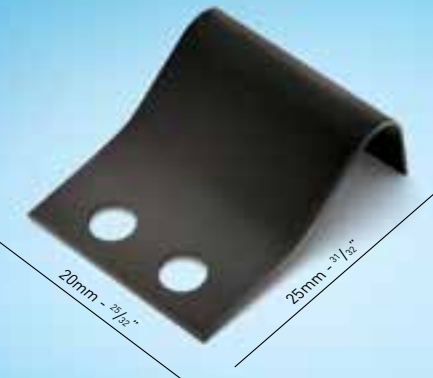

Code: BARRET 42.006.033F

Model: Heidelberg GT046/52/ SM52/MO

Description: Blanket bar retainer

Packing: 1 piece



Code: GAUGEDSTEEL

Description: Gauged steel blade for adjusting ink rollers

Packing: 1 piece

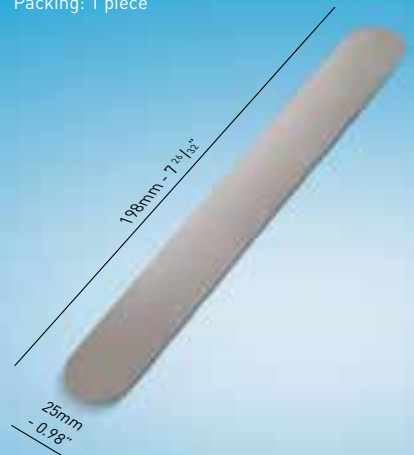

HEIDELBERG - PNEUMATIC SPRINGS - GAUGED STEEL

Code: LIFTDEL 00.580.3118

Description: Pneumatic spring for SM102 delivery

Size: 300 mm/ 11 7/8"

Packing: 1 piece

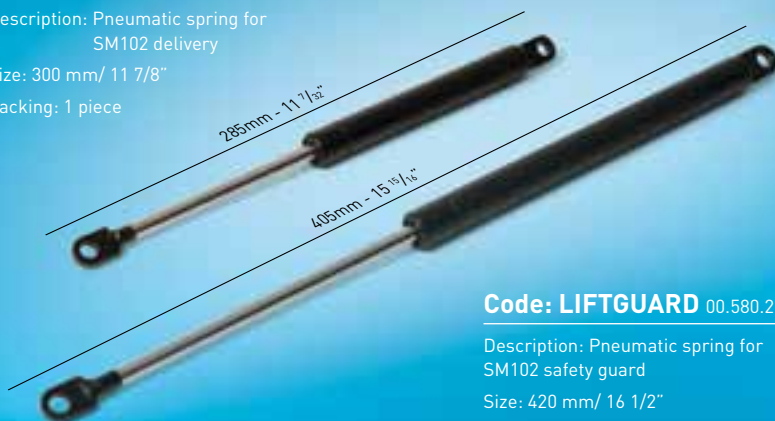

Code: LIFTGUARD 00.580.2722

Description: Pneumatic spring for SM102 safety guard

Size: 420 mm/ 16 1/2"

Packing: 1 piece

FOUNT FILTER

Code: FOUNTFILT01 63.196.1911

Model: All models SM/CD/XL

Description: Filter for fount cooling device

Packing: 1 piece



HEIDELBERG - OIL AND AIR FILTERS

Code: OILFILTHS

Description: Main oil filter for Speedmasters
Packing: 1 piece



Code: OILFILTHL 00.580.1558/02

Description: Main oil filter for Speedmasters
Packing: 1 piece



Code: OILFILT246 00.581.0246/02

Description: Main oil filter cartridge (WG958) for SM52/102-CS92-SX52/102-CD74/102 XL75/105/106/145/162-Primefire 106
Packing: 1 piece



Code: AFH5379 00.580.5379

Description: Air filter SF-960255 for SM/CD/CX/SX/XL presses.
Packing: 1 piece



Old Code: AIRFILTHL

Code: AFH6146 00.580.6146

Description: Air filter FA001105 for SM/CD/CX/SX/XL presses.
Packing: 1 piece



Old Code: AIRFILTHS

Code: AFH4992 00.580.4992

Description: Air filter for all SM/CD/CX/SX/XL presses
Packing: 1 piece



Code: AFH3702 00.780.3702

Description: Air filter for spray powder unit for SM/CD/CX/SX/XL presses.
Packing: 1 piece



Code: AFH1510 L8.164.1510 /WEKO 32150

Description: Air filter for spray powder unit for SM/CD/CX/SX/XL presses.
Packing: 1 piece



Code: AFH8106 47.018.106

Description: Air filter 730.512 for SM74/CD74/SM102/CD102/SX/CX/XL presses.
Packing: 1 piece



HEIDELBERG - SHEET SMOOTHER (SHEET HOLD DOWNS)

Code: HSHSC

Model: SM102/SM74/SM72/S-Offset

Description: Sheet smoother - small
Complete unit with holder

Packing: 1 piece



Code: HSHLC 66.072.084F

Model: SM102/SM74/SM72/S-Offset

Description: Sheet smoother - large
Complete unit with holder

Packing: 1 piece



Code: HSHLLCR C4.372.384F

Model: SM102/SM74/SM72/S-Offset

Description: Sheet smoother - lateral right
Complete unit with holder

Packing: 1 piece

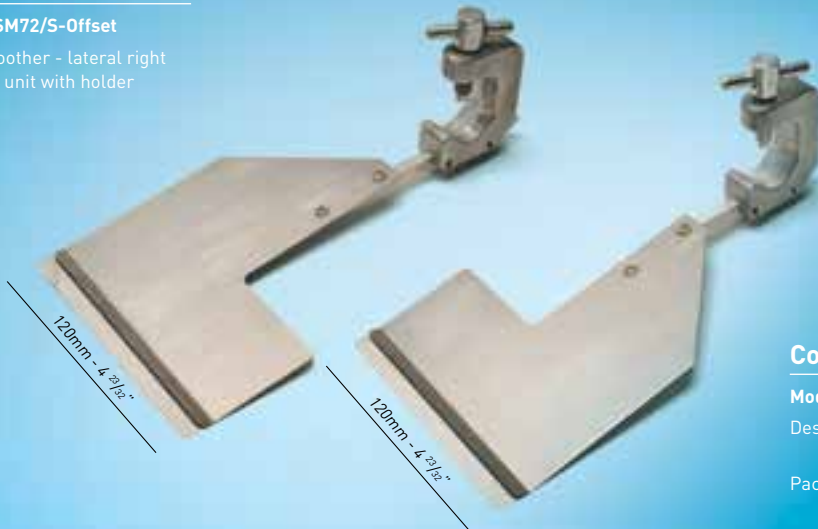

Code: HSHLLCL C4.372.383F

Model: SM102/SM74/SM72/S-Offset

Description: Sheet smoother - lateral left
Complete unit with holder

Packing: 1 piece

Code: HSHNC210 66.072.089F

Model: SM102/SM74/SM72/S-Offset

Description: Sheet smoother - narrow - 210mm
Complete unit with holder

Packing: 1 piece

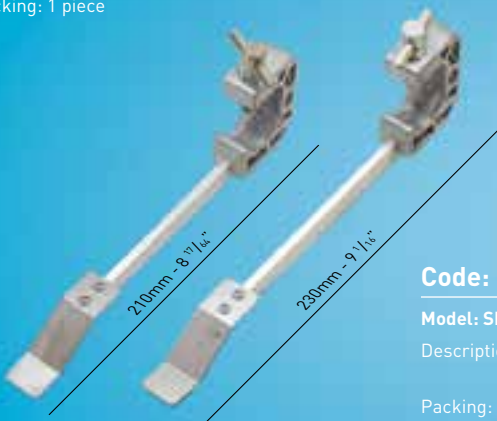

Code: HSHNCR 66.072.082F

Model: SM102

Description: Sheet Smoother
Lateral Right Cpl.
unit with holder

Packing: 1 piece



Code: HSHNCL 66.072.080F

Model: SM102

Description: Sheet Smoother
Lateral Left Cpl.
unit with holder

Packing: 1 piece

Code: HSHNC230 66.891.001F

Model: SM102/SM74/SM72/S-Offset

Description: Sheet smoother - narrow - 230mm
Complete unit with holder

Packing: 1 piece

HEIDELBERG - SHEET SMOOTHER (SHEET HOLD DOWNS)

Code: HSHS 58.022.396

Model: : SM102/SM74/SM72/S-Offset

Description: Sheet smoother - small

Packing: 1 piece



Code: HSHL 66.072.096

Model: : SM102/SM74/SM72/S-Offset

Description: Sheet smoother - large

Packing: 1 piece

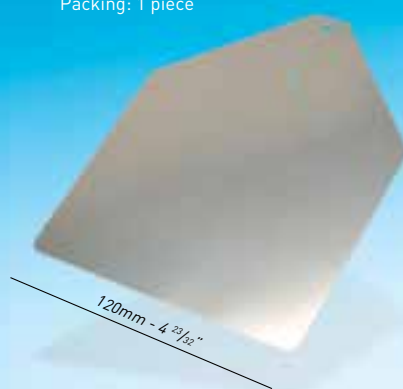

Code: HSHLL

Model: : SM102/SM74/SM72/S-Offset

Description: Sheet smoother - lateral

Packing: 1 piece



HEIDELBERG - SHEET STOPS (GUIDE STRAPS)

Code: GSGT04652

Description: Sheet stop for GT046/GT052

Packing: 1 piece



Code: GSKORD64

Description: Sheet stop for KORD64

Packing: 1 piece



Code: GSKORD64F

Description: Sheet stop with top finger for KORD64

Packing: 1 piece



HEIDELBERG - O-RINGS

Code: ORM0GT0

Model: MO/GT0 00.580.1069

Inside dia.: 46mm/1 13/16"

Packing: 6 pcs/pack



Code: ORSM52

Model: SM52 00.580.4270

Inside dia.: 62mm/2 7/16"

Packing: 6 pcs/pack



Code: OR1026953

Model: SM102/CD102 00.580.6953

Inside dia.: 68mm/2 11/16"

Packing: 6 pcs/pack



Code: OR1021617

Model: SM102 (old)/SM72 00.580.1617

Inside dia.: 80mm/3 1/32"

Packing: 6 pcs/pack



HEIDELBERG - PARTS FOR PLATEN T AND GT

Code: SHEETGTC

Description: Centre sheet separator, forked for T and GT

Thickness: 0.1mm/0.004"

Packing: 1 piece

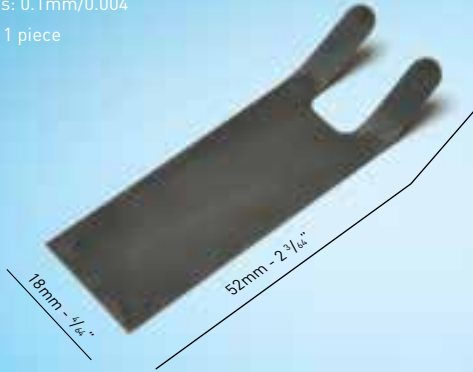

Code: SHEETGTL

Description: Lateral spring, long for T and GT

Packing: 1 piece

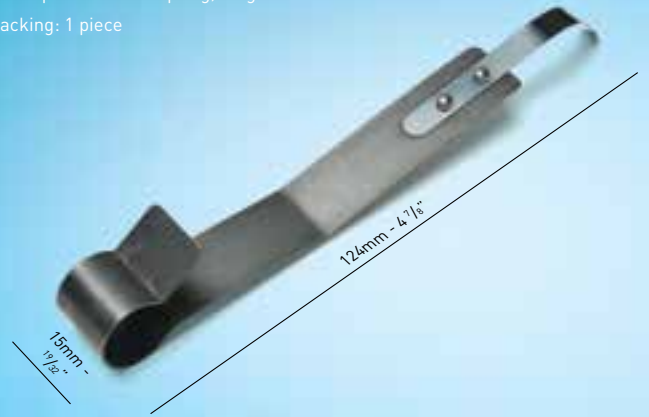

Code: HEID33

Description: Wash-up blade for Platen T 10"x15"

Size: 390 x 51 x 6mm - 5 slots
15 23/64" x 2 1/64" x 15/64"

Packing: 1 piece



Code: HEID34

Description: Wash-up blade for Platen GT 13"x18"

Size: 470 x 51 x 6mm - 6 slots
18 1/2" x 2 1/64" x 15/64"

Packing: 1 piece



HEIDELBERG - TOOLS FOR GTO/MO/72/74/102

Code: TLE 44117

Size: 4 x 117 x 4mm



Code: TLE 64150

Size: 6 x 150 x 4mm



Code: TLE 68225

Size: 6 x 225 x 8mm



Code: TLC 8210

Size: 210 x 8mm



Code: TLE 66245

Size: 6 x 245 x 6mm



Code: TLE 88245

Size: 8 x 245 x 8mm



Code: TLE 1010300

Size: 10 x 300 x 10mm



Code: TLB 10233

Size: 233 x 10mm



Code: TLC 114210

Size: 4 x 210 x 11mm



HEIDELBERG - PARTS FOR PLATEN T AND GT

| | |
|----------------|------------------------|
| Code: | |
| LP02146 | Lay Pins 35mm/1 3/8" |
| LP02147 | Lay Pins 45mm/1 49/64" |
| LP02148 | Lay Pins 55mm/2 11/64" |
| LP02149 | Lay Pins 65mm/2 9/16" |
| LP02150 | Lay Pins 75mm/2 61/64" |

Packing: 25 pcs/bag

FLAT SIDE SHEET SEPARATORS

Code: SHEET333435

Description: One complete set

Packing: 4 pcs/90 x 6 x 0.15mm
2 pcs/120 x 6 x 0.20mm
2 pcs/150 x 6 x 0.30mm



Code: SHEET1233 90 x 6 x 0.15mm

Code: SHEET1234 120 x 6 x 0.20mm

Code: SHEET1235 150 x 6 x 0.30mm

Packing: 12 pcs/pack



Code: CJHGT

Description: Cutting jacket
Platen GT 13"x18"

Packing: 1 piece



Code: CJHT

Description: Cutting jacket
Platen T 10"x15"

Packing: 1 piece

Wash-up bottles, sponges, blanket scrubbers, wiper pads, steel and brass brushes

Code: WU16

Description: Wash-up bottle - 500 ml/16 oz

Packing: 1 piece

Code: WU32

Description: Wash-up bottle - 1 liter/32 oz

Packing: 1 piece

New flexible nozzle / cap



All supplied in a box with 4 bottles



Flexible nozzle

This 1 liter bottle - clear with small cap has a flexible nozzle/straw.

Code: WU1000

Description: Wash-up bottle - clear with straw - 1 liter/32 oz

Packing: 1 piece

Code: WU32S

Description: 1 set comprising 4 bottles and 7 caps with straws:

4 red, 1 yellow, 1 blue, 1 black

Packing: 1 set/box

VISKOVITA SPONGES

Code: VSPON

This 115x35mm compressed cellulose sponge swells to a handy 150 x100mm. Highly durable it does not break down even after prolonged use with pressroom chemicals.

Packing: 1 piece wrapped in cellophane



BLANKET SCRUBBER

The Blanket Scrubber effortlessly cleans off ink, gum, varnish, paper lint, clay and spray powder from the blanket as well as rollers and press frames.

The Blanket Scrubber is an open mesh nylon pouch containing a cellulose sponge.

The scrubbing action of the Blanket Scrubber completely cleans and rejuvenates the blanket surface.

One scrubber will replace hundreds of shop towels.

Simply soak the Blanket Scrubber in your favorite blanket wash, squeeze out excess liquid and it is ready to use.

Code: SCRUBBERM

Description: Blanket Scrubber Medium - Green

Size: 114x159mm/4 31/64" x 6 17/64"

Packing: 6 pcs/pack

Code: SCRUBBERXL

Description: Blanket Scrubber Large - Green

Size: 140x180mm/5 33/64" x 7 3/32"

Packing: 6 pcs/pack

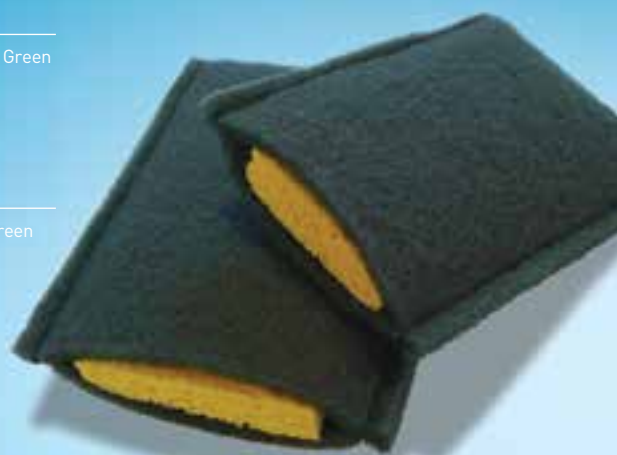

WIPER PAD

Code: WIPERPAD

Description: Wiper Pad - White

Size: 75x175x125mm

Packing: 1 piece/pack



STEEL AND BRASS BRUSHES

Code: BRUSHSTEEL

Description: Steel Brush for cleaning ceramic anilox rollers

Size: 110 x 60mm - 4 21/64" x 2 23/64"

Packing: 1 piece/box



Code: BRUSHBRASS

Description: Brass Brush for cleaning chrome anilox rollers

Size: 110 x 60mm - 4 21/64" x 2 23/64"

Packing: 1 piece/box



Grippers and Gripper Pads



GRIPPERS AND GRIPPER PADS

Code: ZF2581727

OEM: F2.581.727
 Model: XL105 Impression
 Hooked gripper - Urethane



Code: ZC3011727

OEM: C3.011.727
 Model: SM102/CD102 Impression/Transfer
 Gripper - Urethane



Code: ZC3581627N

OEM: C3.581.627N (later model)
 Model: SM102 Impression
 Hooked gripper - Steel



Code: Z49011027

OEM: 49.011.027 (early model)
 Model: SM102 Impression/Transfer
 Hooked gripper - Steel



Code: Z91580337

OEM: 91.580.337
 Model: SM102/SM72 Upper Pincer



Code: ZF4005126

OEM: F4.005.126
 Model: XL105 Transfer
 Winged gripper - Urethane



Code: ZC3011627

OEM: C3.011.627
 Model: SM102/CD102 Impression/Transfer
 Gripper - Steel



Code: Z91581827N

OEM: 91.581.827N (early model)
 Model: SM102/SM72 Impression
 Hooked gripper - Urethane



Code: Z82582727N

OEM: 82.582.727N (later model)
 Model: SM102 Double Drum
 Hooked gripper - Urethane



Code: Z91580338

OEM: 91.580.338 / 82.583.338
 Model: SM102/SM72
 Lower Pincer gripper - Steel



Code: ZF4005125

OEM: F4.005.125
 Model: XL105 Transfer
 Winged gripper - Urethane



Code: ZC3581727N

OEM: C3.581.727N (later model)
 Model: SM102 Impression
 Hooked gripper - Urethane



Code: Z49011827F

OEM: 49.011.827F (early model)
 Model: SM102/SM72 Impression/Transfer
 Gripper - Urethane



Code: Z82582627N

OEM: 82.582.627N (later model)
 Model: SM102 Double Drum
 Hooked gripper - Steel



Code: Z27013049

OEM: 27.013.049F
 Model: SM102/SM72/SO/MO Ranger Drum
 Gripper - Urethane



GRIPPERS AND GRIPPER PADS

Code: Z93014307

OEM: 93.014.307
 Model: SM102/CD102 Delivery
 Gripper Finger



Code: ZM4011727

OEM: M4.011.727
 Model: SM74/SM52 Impression/Transfer
 Gripper - Urethane



Code: Z43020035 (old code: GTO4302035)

OEM: 43.020.035F
 Model: GTO/MO/KORD Feed Table
 Gripper - Rubber pad w/air hole



Code: Z52580363

OEM: 52.580.363
 Model: GTO/MO Lower Pincer
 Gripper - half grip - Steel



Code: Z69011827

OEM: 69.011.827
 Model: GTO Impression/Transfer
 Gripper - Urethane



Code: ZM2583637

OEM: M2.583.637
 Model: SM74/PM74/SM52 Upper Pincer
 Gripper - Urethane



Code: Z69011727B

OEM: 69.011.727 (old model)
 Also refer to Z69011827
 Model: MO Transfer
 Gripper - Urethane

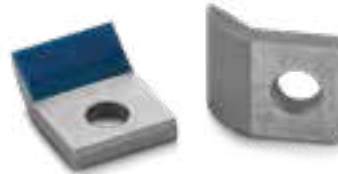

Code: Z43020035NH (old code: GTO2035F)

Description: Same as 43.020.035F
 w/out air hole
 Model: GTO/MO/KORD Feed Table
 Gripper - Rubber pad



Code: Z79580637

OEM: 79.580.637
 Model: GTO/MO Upper Pincer
 Gripper - full grip - Urethane



Code: Z69011727

OEM: 69.011.727
 Model: GTO Impression/Transfer
 Gripper - Steel



Code: ZM2583398

OEM: M2.583.398
 Model: SM74/PM74/SM52 Lower Pincer
 Gripper - Steel



Code: Z52581027

OEM: 52.581.027
 Model: GTO/MO Impression/Transfer
 Hooked gripper - Urethane



Code: Z79580662

OEM: 79.580.662
 Model: GTO/MO Upper Pincer
 Gripper - half grip - Urethane



Code: Z52580338

OEM: 52.580.338
 Model: GTO/MO Lower Pincer
 Gripper - full grip - Steel



Code: ZL4014003

OEM: L4.014.003/05
 Model: SM74/CD74/XL75/XL105 Delivery
 Gripper - Steel



Code: ZM2014011

OEM: M2.014.011
 Model: SM74 Delivery
 Hooked gripper, right - Steel

**Code: Z14875001NR** (old code: KORD7501NR)

Model: SM52/GTO/KORD Delivery
 Gripper - Without rubber pad

**Code: Z03014051** (old code: S1451F)

OEM: 03.014.051F
 Model: S/SB/SBG/SBD Carriage
 Gripper - Rubber pad

**Code: ZC3011820C**

OEM: C3.011.820
 Model: SM102/CD102 - Cross groove

**Code: ZC3581920**

OEM: C3.581.920
 Model: CD102 - T-Shaped -
 Diamond groove

**Code: ZM2015004**

OEM: M2.015.004
 Model: SM74 Delivery
 Hooked gripper, left - Steel

**Code: Z43014004**

OEM: 43.014.004
 Model: MO Delivery
 Gripper - Urethane

**Code: ZC3011920**

OEM: C3.011.920
 Model: SM102/CD102 - Diamond groove

**Code: Z93525310**

OEM: 93.525.310
 Model: SM102/CD102

**Code: Z91581620**

OEM: 91.581.620
 Model: SM102/SM72 - T-Shaped -
 Cross groove

**Code: Z14875001** (old code: GTO1487501)

OEM: 14.875.001F
 Model: SM52/GTO/KORD Delivery
 Gripper - Rubber pad

**Code: Z14014041**

OEM: 14.014.041
 Model: GTO/KORD Delivery
 Backing Plate

**Code: ZC3011820**

OEM: C3.011.820
 Model: SM102/CD102 - Parallel groove

**Code: Z58711101**

OEM: 58.711.101
 Model: SM102/CD102/SO - Cross groove



Ink Knives

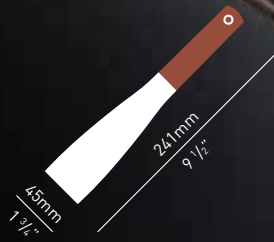

Code: KNIFEMT45



Code: KNIFEMT60



Code: KNIFEMT75

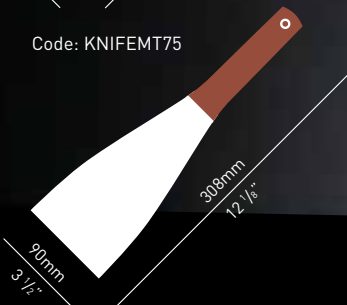

Code: KNIFEMT90

INK KEYS

Code: **INKKEY**

Ink Key Large

Ink key for standard vacuum ink cans
Packing: 10 pcs/box



Code: **INKKEYS**

Ink Key Small

Ink key for Japanese and small ink cans
Packing: 10 pcs/box



PLASTIC INK KNIVES

Code: KNIFE

4 knives/box - 25 boxes/carton
270 x 70mm (10 3/4" x 2 3/4")
Yellow, red, blue and black

Print name or logo
with order of
500+ sets

World Ink Corporation
1-800-888-8888

WHITE FLEXIBLE PLASTIC INK KNIFE

Code: KNIFEJ

White flexible plastic ink knife
300 x 80mm (11 3/4" x 3 1/8")
Packing: 1 piece





Paper Wedges

Aluminium Paper Pile Corners

Precision cut to exact height and uniformly bent

- Conveniently punched holes for easy handling
- Rounded corners and edges to protect hands and fingers
- Space saving - easily stacked and stored in a cabinet

| Code | Size (inch) |
|------------------|----------------|
| PPCRNR6X5 | 6" x 5" |
| PPCRNR9X5 | 9" x 5" |

Packing: 8 pcs/box



PAPER WEDGES



All 3 models are also offered individually.

Code: WEGL Large wedge
Size (LxWxH) 200 x 80 x 25 mm
 7 7/8" x 3 5/32" x 1"

Code: WEGM Medium wedge
Size (LxWxH) 200 x 60 x 30 mm
 7 7/8" x 2 23/64" x 1 1/4"

Code: WEGS Small wedge
Size (LxWxH) 200 x 30 x 30 mm
 7 7/8" x 1 5/16" x 1 1/4"

Combi Pack
Code: WEGC1 1 small, 1 medium, 1 large wedge

Code: WEGB Baby wedge
Size (LxWxH) 100 x 33 x 29 mm
 3 15/16" x 1 19/64" x 1 9/64"
 Packing: 4 pcs/box



Combi Pack
Code: WEGC2 2 large wedges
 Packing: 2 pcs/box



REEL CUTTER

Code: RCUT Large wedge
Size (LxH) 245 x 95 mm
 9 1/2" x 3 5/8"
 Packing: 1 piece



Combi Pack
Code: WEGC3 2 small, 2 medium wedges



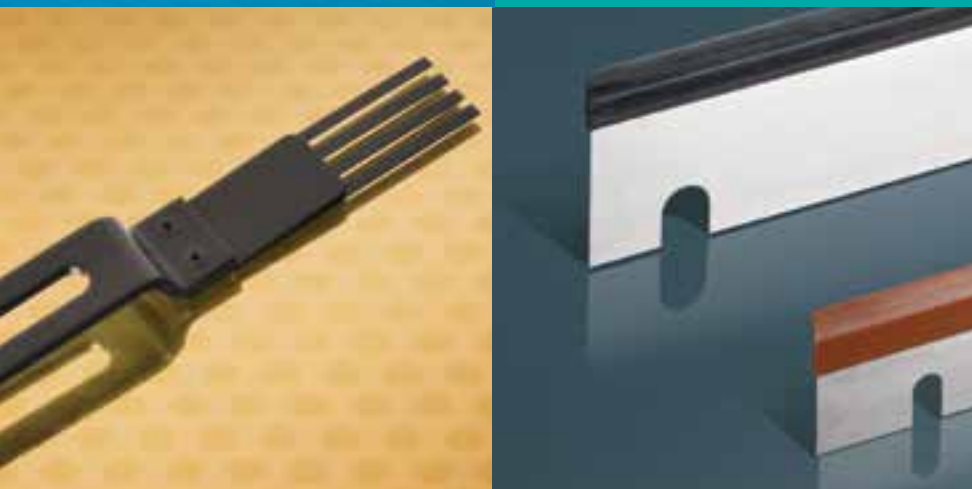
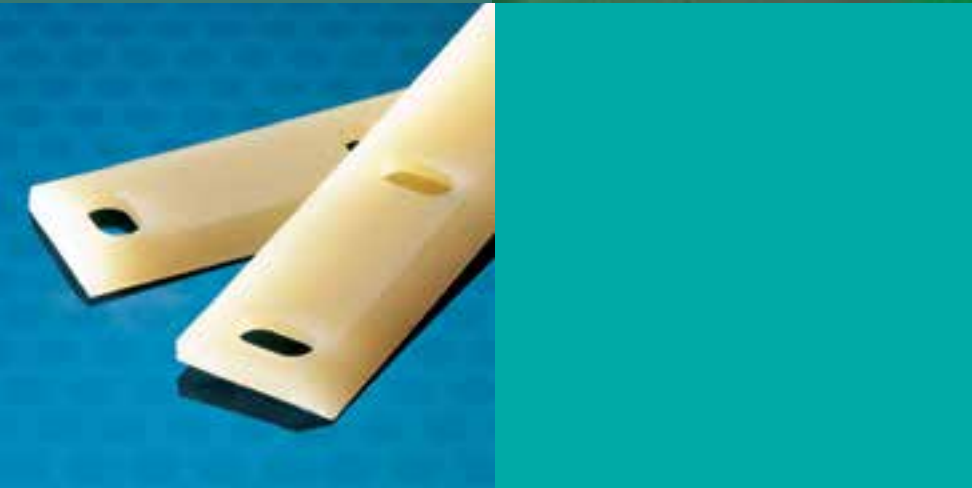

7553

Illuminated Microscope with focus and **50X magnification.**

This model is produced in black and clear hard durable plastic and delivered in individual black vinyl pouches in printed cardboard boxes.



7553

OPENBRIG 10X

Openbrig magnifying glass with **10X magnification.**

The Openbrig magnifying glass is produced in strong black and clear PVC and delivered in individual round vinyl pouch with zipper.



OPENBRIG10X

MEASURING GLASS 10X

Measuring magnifying glass with **10X magnification.**

The measuring glass has an aluminium stand with a glass bottom, showing millimeter measurements. It is produced in strong black plastic with optical lens and delivered in individual cardboard boxes.



MGLASS10X

Magnifying Glasses

All magnifying glasses can be delivered with name and logo printed on the magnifying glass.
Minimum order for printing is 500 pieces of individual models.

MAG6X, MAG8X and MAG10X are produced in black lacquered metal with two optical glass lenses in small individual vinyl pouches



MAG6X

Large magnifying glass with **6X magnification**



MAG8X

Medium magnifying glass with **8X magnification**



MAG10X

Small magnifying glass with **10X magnification**



MAGLIGHT10X

Magnifying glass with **10X magnification** with light and measuring scale in mm and inches. Supplied in a vinyl pouch with batteries being optional.



MAGSOL6X

Large magnifying glass with **6X magnification**. Solid back - giving extra space for company name, logo or general advertising. This model is produced in black lacquered metal with one optical glass lens. Supplied in vinyl pouch.



Cutting Sticks

CUTTING STICKS FOR GUILLOTINES AND THREE KNIFE TRIMMERS

Complete in-house design and production capabilities allows us a high level of control every step of the way. Skilled chemists and engineers work together to ensure the finished products meet the needs of our customers.

Master Cutting Sticks are manufactured in modern production facilities to original equipment manufacturer specifications with tolerances of +/- 0.025mm (+/- 0.001") and our engineering staff select materials that optimize the performance and durability of all products.

All cutting sticks are manufactured with virgin plastic compounds formulated for each application and comply with world-wide environmental regulations.

General Product Guide

| Material | Colour | Quality | Hardness Shore "D" | Application |
|----------|----------------|-----------|--------------------|-----------------------|
| uPVC | Red | Original | 80-82 | Standard steel knives |
| HDPE | Green Or White | Economy | 67-68 | All knives except TCT |
| PP | Grey Or Red | Universal | 72-75 | All knives |
| Nylon | White | Premium | 80-83 | HSS & TCT knives |



B

PP or Nylon cutting sticks with 2 beveled edges for certain Kolbus trimmers.

BS

4H are cutting sticks with 4 holes in each end for IDEAL guillotines.

4H

QR1

QR1 & QR2 are "Quick Release" cutting sticks for IDEAL 4205, 4215 and 4250 as well as 4305, 4315, 4350 and 4705 cutting machines.

QR2

SPECIAL SIZES



Each pack of cutting sticks is clearly labeled with a product code describing type of material, size and length for easy identification.

Mag Pads



An inexpensive way to protect your delicate paper stock (like NCR and carbon) from marks or damages often caused by guillotine clamps.

Also excellent for protecting products with uneven surfaces such as perfect bound booklets.

The high density foam pad prevents sharp edges of the clamp fingers from marking the stock.

The Mag Pad is securely held in place on the clamp during cutting by the tough magnetic rubber surface lining the back side of the pad.

Quick and easy to use. This Mag Pad will not damage the knife if cut into - making it a perfectly safe product to use.

Code: MAGPAD381X76

Size: 381x76mm (15"x 3")

Packing: 2 pads/pack

Knife Guards

For Guillotines and 3-Knife Trimmers

Our heavy duty knife guards ensure excellent protection of the knife edge off and on the machine, during servicing of the machine as well as when transporting the knife.

The knife guard is made of thick, durable, red UPVC, equipped with a wide magnetic strip and formed to ensure the knife guard is held securely in place on the knife.

Black and yellow safety hazard strips are applied on both sides for increased safety. Supplied cut to size or in 2 meter length for local sizing. Order knife guards 20-30mm longer than the length of the knife.

Knife guards can also be supplied with end stops/screws according to customer specifications.

Code: KGUARD

Size: 60mm width in any length up to 2 meter

Packing: 1 piece supplied in plastic sleeve

Frequently ordered sizes:

| Code | Length |
|-------------------|--------|
| KGUARD380 | 380mm |
| KGUARD400 | 400mm |
| KGUARD430 | 430mm |
| KGUARD440 | 440mm |
| KGUARD450 | 450mm |
| KGUARD470 | 470mm |
| KGUARD480 | 480mm |
| KGUARD560 | 560mm |
| KGUARD570 | 570mm |
| KGUARD585 | 585mm |
| KGUARD590 | 590mm |
| KGUARD600 | 600mm |
| KGUARD610 | 610mm |
| KGUARD700 | 700mm |
| KGUARD1000 | 1000mm |
| KGUARD1100 | 1100mm |
| KGUARD1200 | 1200mm |
| KGUARD1400 | 1400mm |
| KGUARD1450 | 1450mm |
| KGUARD1500 | 1500mm |
| KGUARD1700 | 1700mm |
| KGUARD1800 | 1800mm |

Jogger Blocks

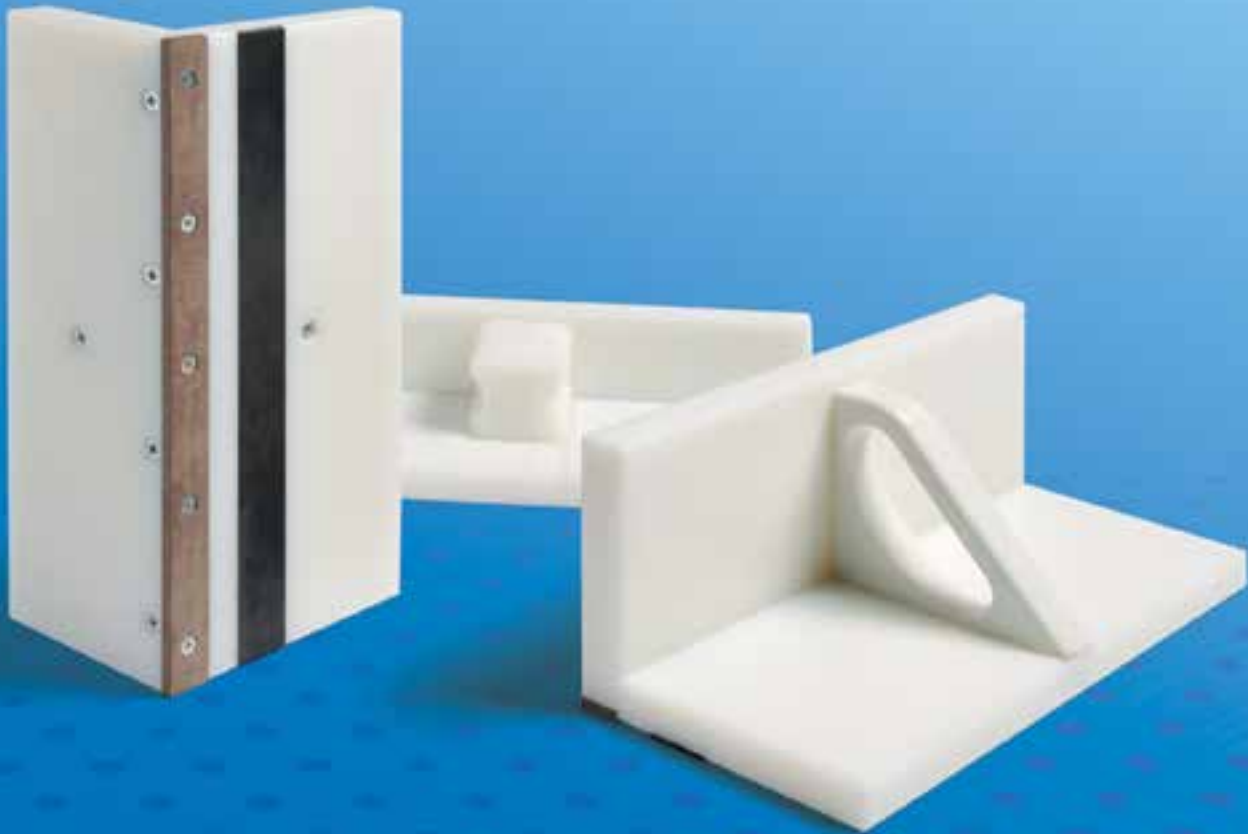

Master Jogger Blocks are made in tough, durable HDPE plastic and come with a Tufnell wear strip ensuring bottom sheet accuracy is maintained throughout the jogger blocks long working life.

Each jogger block is equipped with a magnetic strip in the base to help jog bottom sheets perfectly.

All medium and large jogger blocks are supplied with the “pistol grip” handle for comfortable long term use.

This unique grip handle is not only more comfortable to use but also much stronger than the standard round “pin” handle in case the jogger block is accidentally dropped.

Each jogger block is thoroughly tested before shipment and packed individually in a strong box with padding.

| Code | Height x Length |
|-------------|------------------------|
|-------------|------------------------|

With comfortable block handle

| | |
|------------------|-------------|
| JB75X250 | 75 x 250mm |
| JB75X300 | 75 x 300mm |
| JB100X200 | 100 x 200mm |
| JB100X250 | 100 x 250mm |
| JB100X300 | 100 x 300mm |

With pistol grip handle

| | |
|------------------|-------------|
| JB125X250 | 125 x 250mm |
| JB125X300 | 125 x 300mm |
| JB125X400 | 125 x 400mm |
| JB150X300 | 150 x 300mm |
| JB150X400 | 150 x 400mm |
| JB150X450 | 150 x 450mm |
| JB150X600 | 150 x 600mm |

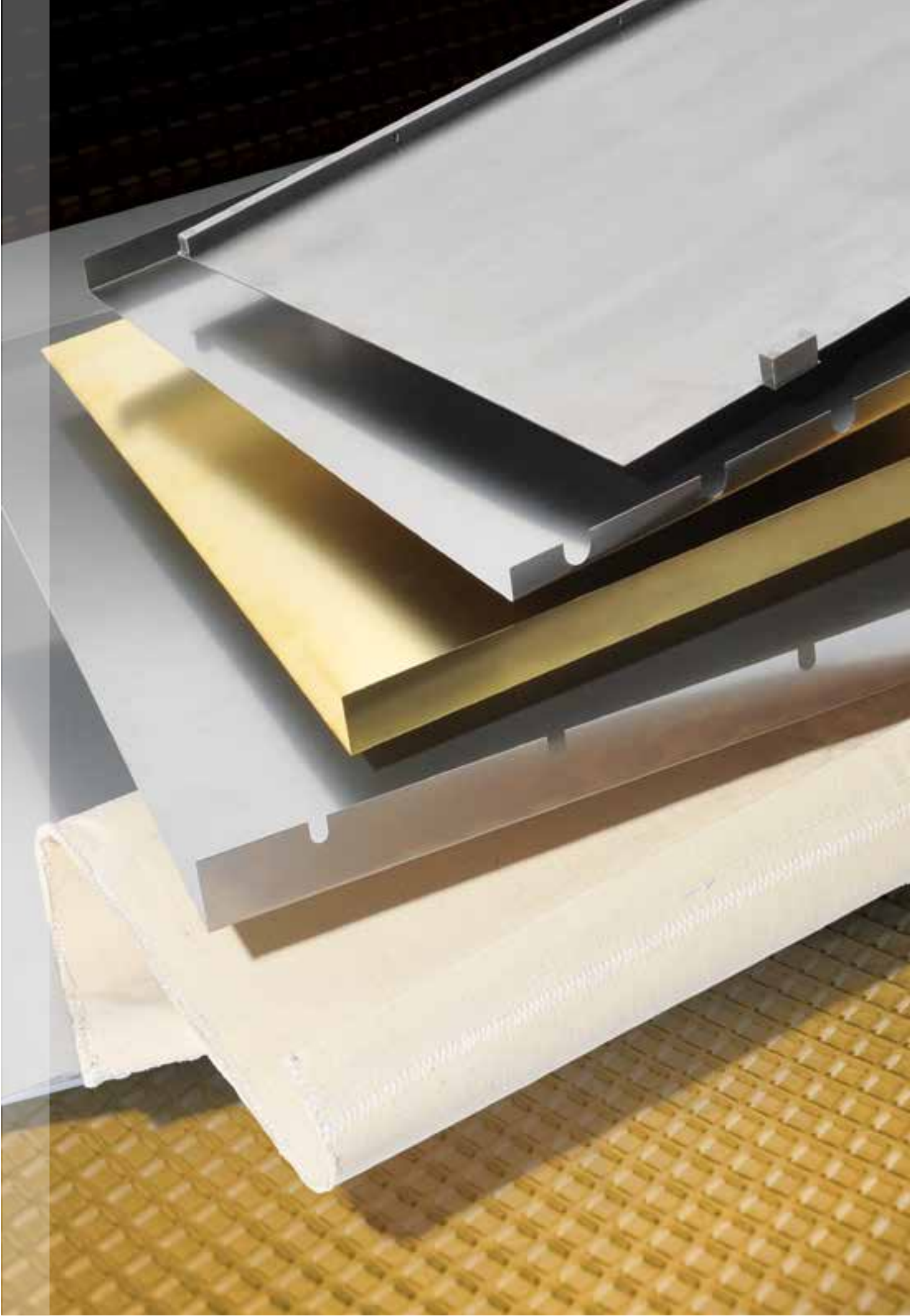



Cylinder Jackets

JACKET THICKNESS 0.30MM/0.012"

| | | | | MM | | | INCH | | |
|------------------------|-----------|-------------------|----------|-----|--------------|------|-------|--------------|----------|
| MACHINE TYPE | CODE | MODEL | MATERIAL | THK | MACHINE SIZE | | THK | MACHINE SIZE | |
| HEIDELBERG | CJBHPM46 | PM 46/QM46 | BRASS | 0.3 | 340 | 460 | 0.012 | 13 25/64 | 18 7/64 |
| | CJHPM46 | PM 46/QM46 | STEEL | 0.3 | 340 | 460 | 0.012 | 13 25/64 | 18 7/64 |
| | CJBHGT046 | GTO 46 | BRASS | 0.3 | 320 | 460 | 0.012 | 12 19/32 | 18 7/64 |
| | CJNHGT046 | GTO 46 | NYLON | 0.5 | 320 | 460 | 0.020 | 12 19/32 | 18 7/64 |
| | CJHGT046 | GTO 46 | STEEL | 0.3 | 320 | 460 | 0.012 | 12 19/32 | 18 7/64 |
| | CJBHGT052 | GTO 52/PM 52 | BRASS | 0.3 | 360 | 520 | 0.012 | 14 11/64 | 20 15/32 |
| | CJNHGT052 | GTO 52/PM 52 | NYLON | 0.5 | 360 | 520 | 0.020 | 14 11/64 | 20 15/32 |
| | CJHGT052 | GTO 52/PM 52 | STEEL | 0.3 | 360 | 520 | 0.012 | 14 11/64 | 20 15/32 |
| | CJHSM52 | SM 52 | STEEL | 0.3 | 360 | 520 | 0.012 | 14 11/64 | 20 15/32 |
| | CJBHSM52 | SM 52 | BRASS | 0.3 | 360 | 520 | 0.012 | 14 11/64 | 20 15/32 |
| | CJNHSM52 | SM 52 | NYLON | 0.5 | 360 | 520 | 0.020 | 14 11/64 | 20 15/32 |
| | CJHMO | MO 65 | STEEL | 0.3 | 480 | 650 | 0.012 | 18 57/64 | 25 19/32 |
| | CJHSM72 | SM 72 | STEEL | 0.3 | 520 | 720 | 0.012 | 20 15/32 | 28 11/32 |
| | CJHSM74 | SM 74 | STEEL | 0.3 | 520 | 740 | 0.012 | 20 15/32 | 29 9/64 |
| | CJHSM102 | SM 102 = SORS | STEEL | 0.3 | 720 | 1020 | 0.012 | 28 11/32 | 40 5/32 |
| DAVIDSON | CJD501 | 501 | STEEL | 0.3 | 350 | 500 | 0.012 | 13 25/32 | 19 11/16 |
| FUJI- SHINOHARA | CJF52 | FUJI-52 | STEEL | 0.3 | 360 | 520 | 0.012 | 14 11/64 | 20 15/32 |
| | CJF66 | FUJI-66 | STEEL | 0.3 | 480 | 660 | 0.012 | 18 57/64 | 25 63/64 |
| | CJF75 | FUJI-75 | STEEL | 0.3 | 580 | 750 | 0.012 | 22 53/64 | 29 17/32 |
| KOMORI | CJKS26 | SPRINT 26 | STEEL | 0.3 | 460 | 680 | 0.012 | 18 7/64 | 26 49/64 |
| | CJKS28 | SPRINT 28 | STEEL | 0.3 | 520 | 720 | 0.012 | 20 15/32 | 28 11/32 |
| ROLAND | CJRPR00 | PRAKTIKA 00 | STEEL | 0.3 | 360 | 520 | 0.012 | 14 11/64 | 20 15/32 |
| | CJRPR00N | PRAKTIKA 00 (NEW) | STEEL | 0.3 | 360 | 520 | 0.012 | 14 11/64 | 20 15/32 |
| SAKURAI | CJS52 | OLIVER 52 | STEEL | 0.3 | 360 | 520 | 0.012 | 14 11/64 | 20 15/32 |
| | CJS58 | OLIVER 58-258 | STEEL | 0.3 | 440 | 580 | 0.012 | 17 21/64 | 22 53/64 |
| | CJS66 | OLIVER 66 | STEEL | 0.3 | 460 | 660 | 0.012 | 18 7/64 | 25 63/64 |
| | CJS72 | OLIVER 72 | STEEL | 0.3 | 520 | 720 | 0.012 | 20 15/32 | 28 11/32 |

JACKET THICKNESS 0.60MM/0.024"

| | | | | MM | | | INCH | | |
|-------------------|-----------|---------------|----------|-----|--------------|-----|-------|--------------|----------|
| MACHINE TYPE | CODE | MODEL | MATERIAL | THK | MACHINE SIZE | | THK | MACHINE SIZE | |
| HEIDELBERG | CJHKOR | KOR | STEEL | 0.6 | 400 | 570 | 0.024 | 15 3/4 | 22 7/16 |
| | CJHKORA | KORA 57 | STEEL | 0.6 | 460 | 570 | 0.024 | 18 7/64 | 22 7/16 |
| | CJHKORD62 | KORD 62 | STEEL | 0.6 | 460 | 620 | 0.024 | 18 7/64 | 24 7/16 |
| | CJHKORD64 | KORD 64 | STEEL | 0.6 | 460 | 640 | 0.024 | 18 7/64 | 25 13/64 |
| | CJHKORS | KORS 72 | STEEL | 0.6 | 520 | 720 | 0.024 | 20 15/32 | 28 11/32 |
| | CJHT | PLATEN T | STEEL | 0.8 | 254 | 380 | 0.031 | 10 | 15 |
| | CJHGT | PLATEN GT | STEEL | 0.8 | 330 | 457 | 0.031 | 13 | 18 |
| | CJHKS | KS | STEEL | 0.6 | 380 | 520 | 0.024 | 14 61/64 | 20 15/32 |
| | CJHKSB | KSB | STEEL | 0.6 | 400 | 570 | 0.024 | 15 3/4 | 22 7/16 |
| | CJHKSBBA | KSBA | STEEL | 0.6 | 460 | 585 | 0.024 | 18 7/64 | 23 1/32 |
| | CJHKSBBAZ | KSBAZ | STEEL | 0.6 | 460 | 570 | 0.024 | 18 7/64 | 22 7/16 |
| | CJHKSD | KSD | STEEL | 0.6 | 460 | 640 | 0.024 | 18 7/64 | 25 13/64 |
| | CJHS | S (OHZ) | STEEL | 0.6 | 540 | 720 | 0.024 | 21 17/64 | 28 11/32 |
| | CJHSB-SBG | SB-SBG | STEEL | 0.6 | 560 | 770 | 0.024 | 22 3/64 | 30 5/16 |
| | CJHSBG-SP | SBG (SPECIAL) | STEEL | 0.6 | 540 | 770 | 0.024 | 21 17/64 | 30 5/16 |
| | CJHSBB | SBB | STEEL | 0.6 | 570 | 820 | 0.024 | 22 7/16 | 32 9/32 |
| | CJHSBD | SBD | STEEL | 0.6 | 632 | 894 | 0.024 | 24 7/8 | 35 13/64 |
| | CJHSBD-SP | SBD (SPECIAL) | STEEL | 0.6 | 640 | 900 | 0.024 | 25 13/64 | 35 7/16 |

M

HEID14 - Heidelberg SM102/CD102 - Metal/Rubber

U

UMITSUBISHI41 - Mitsubishi 3FH/Diamond 3000

P

ROLAND25 - Roland

Wash-up Blades

Our wash-up blades are manufactured to fine tolerances for perfect fit on old and new presses alike. They are resistant to chemical attack from inks and solvents and are highly efficient and durable.

A perfect profile ensures excellent wash-up results each time, reducing the amount of wash-up chemicals used and reducing down-time on the press.

Our blades are available for the vast majority of offset sheet-fed, web and continuous form presses in either metal/rubber, metal/urethane, rubber (EPDM), plastic or Tufnol format. Each individual blade is presented in a plastic sleeve with the machine reference for easy identification.

- Size and style specification guaranteed
- High resistance to wear
- Accurate fit first time - no adjustment required
- Corrosion-proof steel
- Chemical resistant rubber and plastic
- Individually packed in protective sleeve
- Moulded rubber tip chemically bonded - no breakdown



- Metal/Urethane

d 700 - Plastic

OLIVER04 - Oliver 66 - EPDM Rubber

C

HEID34 - Heidelberg Platen GT - Metal/Rubber Combination

T

HEID84 - Heidelberg KS - Tufnol

| HEIDELBERG | | | | MM | | | INCHES | | | |
|------------|------------|--|------|-----------|-------|-----|----------|---------|-------|----------|
| Part No | Machine | Model | Type | Length | Width | Thk | Length | Width | Thk | No Holes |
| HEID01 | Heidelberg | TOK (plastic) | P | 283 | 43 | 3.0 | 11 9/64 | 1 11/16 | 1/8 | 4 |
| HEID02 | Heidelberg | TOK (metal) | M | 283 | 43 | 0.5 | 11 9/64 | 1 11/16 | 1/64 | 4 |
| HEID03 | Heidelberg | Quickmaster | P | 375 | 43 | 3.0 | 14 49/64 | 1 11/16 | 1/8 | 5 |
| HEID04 | Heidelberg | GTO 46 | M | 500 | 60 | 0.5 | 19 11/16 | 2 23/64 | 1/64 | 5 |
| HEID35 | Heidelberg | GTO 46 Numbering Unit | C | 448 | 40 | 6.0 | 17 41/64 | 1 37/64 | 15/64 | 3 |
| HEID05 | Heidelberg | GTO 52/PRINTMASTER | M | 560 | 60 | 0.5 | 22 3/64 | 2 23/64 | 1/64 | 6 |
| HEID36 | Heidelberg | GTO 52 Numbering Unit | C | 508 | 40 | 6.0 | 20 | 1 37/64 | 15/64 | 3 |
| HEID06 | Heidelberg | MO and SORK Flexi (standard) | M | 710 | 60 | 0.5 | 27 61/64 | 2 23/64 | 1/64 | 8 |
| HEID07 | Heidelberg | MO A/W (short) | M | 692 | 60 | 0.5 | 27 1/4 | 2 23/64 | 1/64 | 7 |
| HEID56 | Heidelberg | MO (rigid) | M | 710 | 60 | 2.0 | 27 61/64 | 2 23/64 | 5/64 | 8 |
| HEID37 | Heidelberg | MO Numbering Unit | C | 648 | 52 | 6.0 | 25 33/64 | 2 3/64 | 15/64 | 3 |
| | | | | | | | | | | |
| HEID09 | Heidelberg | Speedmaster 52 | M | 605 | 46 | 0.5 | 23 13/16 | 1 13/16 | 1/64 | 7 |
| HEID59 | Heidelberg | Speedmaster 52 Numbering Unit | M | 536 | 28 | 0.5 | 21 7/64 | 1 7/64 | 1/64 | 6 |
| HEID10 | Heidelberg | Speedmaster 72 | M | 790 | 60 | 0.5 | 31 7/64 | 2 23/64 | 1/64 | 11 |
| HEID11 | Heidelberg | Speedmaster 72 VP | M | 753 | 40 | 0.5 | 29 41/64 | 1 37/64 | 1/64 | 9 |
| HEID54 | Heidelberg | Speedmaster 72 A/W | M | 742 | 60 | 0.5 | 29 7/32 | 2 23/64 | 1/64 | 8 |
| HEID13 | Heidelberg | Speedmaster 74 - standard (w/slots) | M | 822 | 57 | 0.5 | 32 23/64 | 2 1/4 | 1/64 | 9 |
| HEID08 | Heidelberg | PM74 - Printmaster 74 - standard (w/holes) | M | 822 | 57 | 0.5 | 32 23/64 | 2 1/4 | 1/64 | 9 |
| HEID64H | Heidelberg | SM74/PM74 combination w/2 rows of holes | M | 822 | 57 | 0.5 | 32 23/64 | 2 1/4 | 1/64 | 18 |
| HEID63 | Heidelberg | Speedmaster 74 (long + w/slots) special | M | 826 | 57 | 0.5 | 32 33/64 | 2 1/4 | 1/64 | 9 |
| HEID57 | Heidelberg | Speedmaster CD74/XL75 (long +w/slots) | M | 847 | 47 | 0.5 | 33 11/32 | 1 27/32 | 1/64 | 9 |
| HEID12 | Heidelberg | Speedmaster 102 and SORS (w/holes) | M | 1090 | 60 | 0.5 | 42 29/32 | 2 23/64 | 1/64 | 11 |
| HEID14 | Heidelberg | Speedmaster 102+CD102 (w/slots) | M | 1090 | 60 | 0.5 | 42 29/32 | 2 23/64 | 1/64 | 11 |
| HEID16H | Heidelberg | CD102/CX102 narrow profile (w/slots) | H | 1090 | 57 | 0.5 | 42 29/32 | 2 1/4 | 1/64 | 11 |
| HEID17 | Heidelberg | Speedmaster 102 A/W | M | 1042 | 60 | 0.5 | 41 1/64 | 2 23/64 | 1/64 | 11 |
| HEID46 | Heidelberg | Speedmaster 102 A/W New | M | 1042 | 57 | 0.5 | 41 1/64 | 2 1/4 | 1/64 | 11 |
| HEID18 | Heidelberg | Speedmaster 102 VP | M | 1052 | 40 | 0.5 | 41 27/64 | 1 37/64 | 1/64 | 11 |
| HEID58H | Heidelberg | Speedmaster XL105 (w/slots) | M | 1125 | 41 | 0.5 | 44 19/64 | 1 39/64 | 1/64 | 21 |
| HEID38H | Heidelberg | Speedmaster XL145 (rubber profile:1588mm) | M | 1588/1758 | 52 | 0.5 | 62 33/64 | 2 3/64 | 1/64 | 18 |
| HEID40H | Heidelberg | Speedmaster XL162 | M | 1708 | 52 | 0.5 | 67 1/4 | 2 3/64 | 1/64 | 18 |
| | | | | | | | | | | |
| HEID60 | Heidelberg | SOR Flexi (new model) | M | 890 | 60 | 0.5 | 35 1/32 | 2 23/64 | 1/64 | 9 |
| HEID24 | Heidelberg | SOR Rigid (old model) | M | 890 | 50 | 2.0 | 35 1/32 | 1 31/32 | 5/64 | 10 |
| HEID06 | Heidelberg | SORK Flexi and MO | M | 710 | 60 | 0.5 | 27 61/64 | 2 23/64 | 1/64 | 8 |
| HEID28 | Heidelberg | SORK-65 Rigid | M | 721 | 50 | 2.0 | 28 25/64 | 1 31/32 | 5/64 | 12 |
| HEID30 | Heidelberg | SORM Rigid | M | 790 | 50 | 2.0 | 31 7/64 | 1 31/32 | 5/64 | 12 |
| HEID31 | Heidelberg | SORM/Z Flexi Pre 1995 | M | 753 | 42 | 0.5 | 29 41/64 | 1 21/32 | 1/64 | 9 |
| HEID47 | Heidelberg | SORM/Z Flexi (w/9 holes + 2 slots) | M | 790 | 60 | 0.5 | 31 7/64 | 2 23/64 | 1/64 | 11 |
| HEID25 | Heidelberg | SORD Flexi | M | 960 | 60 | 0.5 | 37 51/64 | 2 23/64 | 1/64 | 10 |
| HEID26 | Heidelberg | SORD Rigid | M | 960 | 50 | 2.0 | 37 51/64 | 1 31/32 | 5/64 | 12 |
| HEID12 | Heidelberg | SORS and SM102 | M | 1090 | 60 | 0.5 | 42 29/32 | 2 23/64 | 1/64 | 11 |
| | | | | | | | | | | |
| HEID19 | Heidelberg | KOR | M | 600 | 50 | 2.0 | 23 5/8 | 1 31/32 | 5/64 | 10 |
| HEID20 | Heidelberg | KORA | M | 622 | 50 | 2.0 | 24 31/64 | 1 31/32 | 5/64 | 10 |
| HEID21 | Heidelberg | KORD 62 | M | 650 | 50 | 2.0 | 25 19/32 | 1 31/32 | 5/64 | 10 |
| HEID22 | Heidelberg | KORD 64 | M | 690 | 50 | 2.0 | 27 11/64 | 1 31/32 | 5/64 | 12 |
| HEID23 | Heidelberg | KORS | M | 760 | 50 | 2.0 | 29 59/64 | 1 31/32 | 5/64 | 12 |
| | | | | | | | | | | |
| HEID33 | Heidelberg | PLATEN 10 x 15 | C | 390 | 51 | 6.0 | 15 23/64 | 2 | 15/64 | 5 |
| HEID34 | Heidelberg | PLATEN 13 x 18 | C | 470 | 51 | 6.0 | 18 1/2 | 2 | 15/64 | 6 |

Legend: **M** = Metal with Rubber **P** = Plastic **E** = EPDM Rubber **C** = Combination **T** = Tufnol **B** = Brass **H** = Narrow Profile

| ABDICK | | | | MM | | | INCHES | | | |
|------------|--------------------|--|------|--------|-------|-----|----------|---------|-------|----------|
| Part No | Machine | Model | Type | Length | Width | Thk | Length | Width | Thk | No Holes |
| ABDICK02 | AB Dick | 375/9810 | E | 338 | 52 | 3.0 | 13 5/16 | 2 3/64 | 1/8 | 6 |
| ABDICK03 | AB Dick | 9810 | E | 340 | 57 | 5.0 | 13 25/64 | 2 1/4 | 13/64 | 6 |
| ABDICK07 | AB Dick | 995 | E | 360 | 48 | 5.0 | 14 11/64 | 1 57/64 | 13/64 | 6 |
| AKIYAMA | | | | | | | | | | |
| AKIYAMA01 | Akiyama | Bestech 28 | E | 800 | 47 | 5.0 | 31 1/2 | 1 27/32 | 13/64 | 11 |
| AKIYAMA02 | Akiyama | Bestech 40 | E | 1120 | 55 | 5.0 | 44 3/32 | 2 11/64 | 13/64 | 12 |
| AKIYAMA03 | Akiyama | Bestech 40 | E | 1120 | 45 | 5.0 | 44 3/32 | 1 49/64 | 13/64 | 12 |
| AKIYAMA04 | Akiyama | Bestech 40-640 IIC | E | 1120 | 70 | 5.0 | 44 3/32 | 2 3/4 | 13/64 | 12 |
| AKIYAMA05 | Akiyama | Bestech 40-640 IIC | P | 1120 | 70 | 5.0 | 44 3/32 | 2 3/4 | 13/64 | 12 |
| ADAST | | | | | | | | | | |
| ADAST | Refer to: DOMINANT | | | | | | | | | |
| BLANK | | | | | | | | | | |
| BLANK30 | Blank | Long blade used for local cutting/punching | E | 996 | 34 | 5.0 | 39 7/32 | 1 11/32 | 13/64 | 0 |
| BLANK05 | Blank | | E | 1250 | 55 | 5.0 | 49 7/32 | 2 11/64 | 13/64 | 0 |
| BLANK06 | Blank | | M | 1230 | 40 | 0.5 | 48 27/64 | 1 37/64 | 1/64 | 0 |
| BLANK07 | Blank | | M | 1530 | 40 | 0.5 | 60 1/4 | 1 37/64 | 1/64 | 0 |
| BLANK03 | Blank | | M | 1800 | 50 | 0.5 | 70 55/64 | 1 31/32 | 1/64 | 0 |
| BLANK01 | Blank | | M | 1800 | 60 | 0.5 | 70 55/64 | 2 23/64 | 1/64 | 0 |
| BLANK02 | Blank | | M | 1800 | 65 | 0.5 | 70 55/64 | 2 9/16 | 1/64 | 0 |
| BLANK04 | Blank | | P | 2000 | 65 | 1.0 | 78 47/64 | 2 9/16 | 3/64 | 0 |
| CATANBO | | | | | | | | | | |
| CATANB001 | Catanbo | Meccanica | M | 594 | 48 | 0.5 | 23 25/64 | 1 57/64 | 1/64 | 8 |
| CODIMAG | | | | | | | | | | |
| CODIMAG01 | Codimag | Viva | E | 352 | 34 | 5.0 | 13 55/64 | 1 11/32 | 13/64 | 9 |
| CODIMAG02 | Codimag | Viva 340 | E | 362 | 34 | 5.0 | 14 1/4 | 1 11/32 | 13/64 | 9 |
| CRABTREE | | | | | | | | | | |
| CRABTREE07 | Crabtree | 45 | P | 1220 | 152 | 5.0 | 48 1/32 | 6 | 13/64 | 13 |
| CRABTREE10 | Crabtree | 1200 | M | 1345 | 43 | 0.5 | 52 61/64 | 1 11/16 | 1/64 | 15 |
| DIDDIE | | | | | | | | | | |
| DIDDIE04 | Diddie | Glazer 860 | P | 495 | 35 | 2.0 | 19 31/64 | 1 3/8 | 5/64 | 7 |
| DIDDIE08 | Diddie | VIP | M | 532 | 55 | 0.5 | 20 15/16 | 2 11/64 | 1/64 | 0 |
| DIDDIE03 | Diddie | VIP | P | 571 | 35 | 1.0 | 22 31/64 | 1 3/8 | 3/64 | 8 |
| DOMINANT | | | | | | | | | | |
| DOMINANT01 | Dominant | 414 | E | 300 | 26 | 3.0 | 11 13/16 | 1 1/32 | 1/8 | 8 |
| DOMINANT02 | Dominant | 514/515/516/525/526B | E | 542 | 24 | 3.0 | 21 11/32 | 15/16 | 1/8 | 14 |
| DOMINANT03 | Dominant | 313/314 | E | 544 | 30 | 3.0 | 21 27/64 | 1 3/16 | 1/8 | 14 |
| DOMINANT14 | Dominant | 527 | M | 547 | 40 | 0.5 | 21 17/32 | 1 37/64 | 1/64 | 6 |
| DOMINANT09 | Dominant | 516-526/547-P | E | 557 | 25 | 3.0 | 21 59/64 | 63/64 | 1/8 | 14 |
| DOMINANT06 | Dominant | 714/724/715/725/745 | E | 666 | 30 | 3.0 | 26 7/32 | 1 3/16 | 1/8 | 17 |
| DOMINANT07 | Dominant | 747 | M | 666 | 40 | 0.5 | 26 7/32 | 1 37/64 | 1/64 | 7 |
| DOMINANT17 | Dominant | | P | 670 | 30 | 3.0 | 26 3/8 | 1 3/16 | 1/8 | 0 |
| DOMINANT16 | Dominant | | P | 780 | 40 | 3.0 | 30 45/64 | 1 37/64 | 1/8 | 19 |
| DOMINANT12 | Dominant | 826 | E | 800 | 35 | 2.0 | 31 1/2 | 1 3/8 | 5/64 | 20 |
| FUJI | | | | | | | | | | |
| FUJI01 | Fuji | 50 (Tip to H/C = 38mm) - Rigid | M | 550 | 48 | 2.0 | 21 21/32 | 1 57/64 | 5/64 | 8 |
| FUJI04 | Fuji | 52 New Shinohara - Rigid | M | 550 | 42 | 2.0 | 21 21/32 | 1 21/32 | 5/64 | 7 |
| FUJI10 | Fuji | 52 New Shinohara - Flexi | M | 550 | 42 | 0.5 | 21 21/32 | 1 21/32 | 1/64 | 9 |
| FUJI05 | Fuji | 52 Special - Rigid | M | 570 | 35 | 2.0 | 22 7/16 | 1 3/8 | 5/64 | 8 |
| FUJI06 | Fuji | 52 Standard - Rigid | M | 580 | 42 | 2.0 | 22 53/64 | 1 21/32 | 5/64 | 8 |
| FUJI02 | Fuji | Shinohara 56 New - Rigid | M | 610 | 42 | 2.0 | 24 1/64 | 1 21/32 | 5/64 | 10 |
| FUJI09 | Fuji | 58 - Rigid | M | 620 | 48 | 2.0 | 24 13/32 | 1 57/64 | 5/64 | 9 |
| FUJI14 | Fuji | S66 | M | 692 | 48 | 0.5 | 27 1/4 | 1 57/64 | 1/64 | 11 |

Legend: **M** = Metal with Rubber **P** = Plastic **E** = EPDM Rubber **C** = Combination **T** = Tufnol **B** = Brass **H** = Narrow Profile

| FUJI | | | | MM | | | INCHES | | | |
|------------------|-----------|-------------------------------------|------|--------|-------|-----|----------|---------|-------|----------|
| Part No | Machine | Model | Type | Length | Width | Thk | Length | Width | Thk | No Holes |
| FUJI07 | Fuji | 65/66 - Rigid | M | 700 | 48 | 2.0 | 27 9/16 | 1 57/64 | 5/64 | 11 |
| FUJI03 | Fuji | 74 Shinohara (Blanket Washer) | M | 780 | 30 | 0.5 | 30 45/64 | 1 3/16 | 1/64 | 10 |
| FUJI08 | Fuji | 66AW | P | 693 | 30 | 1.0 | 27 9/32 | 1 3/16 | 3/64 | 9 |
| FUJI12 | Fuji | 74 Shinohara - Flexi | M | 795 | 48 | 0.5 | 31 19/64 | 1 57/64 | 1/64 | 13 |
| FUJI13 | Fuji | 74 Shinohara - Rigid | M | 795 | 48 | 2.0 | 31 19/64 | 1 57/64 | 5/64 | 13 |
| FUJI19 | Fuji | 75 | P | 820 | 30 | 1.0 | 32 9/32 | 1 3/16 | 3/64 | 10 |
| FUJI17 | Fuji | 75 | M | 835 | 48 | 0.5 | 32 7/8 | 1 57/64 | 1/64 | 13 |
| FUJI11 | Fuji | Shinohara 102 Standard - Rigid | M | 1085 | 48 | 2.0 | 42 23/32 | 1 57/64 | 5/64 | 17 |
| FUJI18 | Fuji | | M | 1244 | 65 | 0.5 | 48 31/32 | 2 9/16 | 1/64 | 13 |
| FUJI15 | Fuji | MTP - Flexi | M | 1252 | 65 | 0.5 | 49 19/64 | 2 9/16 | 1/64 | 13 |
| GALLUS | | | | | | | | | | |
| GALLUS07 | Gallus | R 160 | M | 222 | 35 | 0.5 | 8 47/64 | 1 3/8 | 1/64 | 5 |
| GALLUS03 | Gallus | R 200 (p/n 098173) | M | 252 | 35 | 0.5 | 9 59/64 | 1 3/8 | 1/64 | 6 |
| GALLUS02 | Gallus | TSC 250 | M | 292 | 35 | 0.5 | 11 1/2 | 1 3/8 | 1/64 | 0 |
| GIEBLER | | | | | | | | | | |
| GIEBLER06 | Giebler | | E | 623 | 25 | 5.0 | 24 17/32 | 63/64 | 13/64 | 0 |
| GOEBEL | | | | | | | | | | |
| GOEBEL02 | Goebel | Optiforma MOQ 5 pcs | P | 589 | 40 | 1.0 | 23 3/16 | 1 37/64 | 3/64 | 6 |
| GOEBEL04 | Goebel | Ecoprint (w/slots) MOQ 5 pcs | M | 590 | 57 | 0.5 | 23 15/64 | 2 1/4 | 1/64 | 6 |
| GOEBEL07 | Goebel | Optiforma 520 MOQ 5 pcs | P | 615 | 35 | 1.0 | 24 7/32 | 1 3/8 | 3/64 | 6 |
| GOSS | | | | | | | | | | |
| GOSS16 | Goss | A24 (4M034100B / WM.9E010415S) | M | 1036 | 50 | 2.0 | 40 25/32 | 1 31/32 | 5/64 | 12 |
| GOSS09 | Goss | Community - SS C 30 | | | | | | | | |
| GOSS05 | Goss | Universal | M | 1060 | 65 | 0.5 | 41 47/64 | 2 9/16 | 1/64 | 11 |
| HAMILTON | | | | | | | | | | |
| HAMILTON01 | Hamilton | | M | 1125 | 52 | 0.5 | 44 19/64 | 2 3/64 | 1/64 | 12 |
| HARRIS | | | | | | | | | | |
| HARRIS05 | Harris | 1000/M200/M300 | M | 1044 | 65 | 0.5 | 41 7/64 | 2 9/16 | 1/64 | 11 |
| HARRIS14 | Harris | M850 | M | 1064 | 60 | 0.5 | 41 57/64 | 2 23/64 | 1/64 | 11 |
| HARRIS11 | Harris | SUNDAY S2000 (w/slots) | M | 1469 | 50 | 0.5 | 57 53/64 | 1 31/32 | 1/64 | 13 |
| HARRIS19 | Harris | SUNDAY S4000 (w/holes) | M | 1580 | 60 | 0.5 | 62 13/64 | 2 23/64 | 1/64 | 17 |
| HASHIMOTO | | | | | | | | | | |
| HASHIMOTO02 | Hashimoto | AF-S & AF-K | M | 539 | 54 | 0.5 | 21 7/32 | 2 1/8 | 1/64 | 6 |
| HASHIMOTO03 | Hashimoto | 522 | M | 570 | 55 | 0.5 | 22 7/16 | 2 11/64 | 1/64 | 6 |
| HASHIMOTO01 | Hashimoto | 652P | M | 720 | 60 | 0.5 | 28 11/32 | 2 23/64 | 1/64 | 7 |
| HAMADA | | | | | | | | | | |
| HAMADA35 | Hamada | 106-11-31-6 | E | 321 | 45 | 5.0 | 12 21/32 | 1 49/64 | 13/64 | 9 |
| HAMADA40 | Hamada | HSO-700V (old code H04 for 611/612) | E | 335 | 45 | 5.0 | 13 3/16 | 1 49/64 | 13/64 | 9 |
| HAMADA21 | Hamada | HSO-DU34-2 | M | 357 | 34 | 0.5 | 14 1/16 | 1 11/32 | 1/64 | 5 |
| HAMADA29 | Hamada | VS RS34 | M | 357 | 42 | 0.5 | 14 1/16 | 1 21/32 | 1/64 | 5 |
| HAMADA18 | Hamada | HSO-234-2 | M | 372 | 42 | 0.5 | 14 41/64 | 1 21/32 | 1/64 | 5 |
| HAMADA17 | Hamada | HSO-075 | M | 482 | 40 | 0.5 | 18 31/32 | 1 37/64 | 1/64 | 13 |
| HAMADA20 | Hamada | HSO-75 (old code H05 700 CDX NP) | M | 482 | 49.5 | 0.5 | 18 31/32 | 1 61/64 | 1/64 | 13 |
| HAMADA06 | Hamada | E47-2 Group II/I106-11-31-6 | E | 487 | 45 | 5.0 | 19 11/64 | 1 49/64 | 13/64 | 13 |
| HAMADA19 | Hamada | HSO-75 | M | 491 | 49.5 | 0.5 | 19 21/64 | 1 61/64 | 1/64 | 13 |
| HAMADA31 | Hamada | HSO-48 (old code H08 C248 ESF) | M | 514 | 46 | 0.5 | 20 15/64 | 1 13/16 | 1/64 | 14 |
| HAMADA23 | Hamada | HSO-800-2 | M | 540 | 49 | 0.5 | 21 17/64 | 1 59/64 | 1/64 | 14 |
| HAMADA22 | Hamada | ZL-4911-2 | M | 540 | 55 | 0.5 | 21 17/64 | 2 11/64 | 1/64 | 6 |
| HAMADA24 | Hamada | HSO-252C | M | 554 | 40 | 0.5 | 21 13/16 | 1 37/64 | 1/64 | 15 |
| HAMADA41 | Hamada | Krampus 52/R-209 (old code H12) | E | 560 | 45 | 5.0 | 22 3/64 | 1 49/64 | 13/64 | 9 |
| HAMADA25 | Hamada | B 452 | M | 570 | 40 | 0.5 | 22 7/16 | 1 37/64 | 1/64 | 15 |
| HAMADA32 | Hamada | PM-066-4912-00 | M | 570 | 55 | 0.5 | 22 7/16 | 2 11/64 | 1/64 | 6 |

Legend: **M** = Metal with Rubber **P** = Plastic **E** = EPDM Rubber **C** = Combination **T** = Tufnol **B** = Brass **H** = Narrow Profile

| HAMADA | | | | MM | | | INCHES | | | |
|----------|---------|---|------|--------|-------|-----|----------|---------|-------|----------|
| Part No | Machine | Model | Type | Length | Width | Thk | Length | Width | Thk | No Holes |
| HAMADA26 | Hamada | ZK-4911-3 | M | 610 | 55 | 0.5 | 24 | 2 11/64 | 1/64 | 6 |
| HAMADA27 | Hamada | SA-4912 | M | 620 | 55 | 0.5 | 24 13/32 | 2 11/64 | 1/64 | 7 |
| HAMADA33 | Hamada | PM-069-4912-00 | M | 620 | 55 | 0.5 | 24 13/32 | 2 11/64 | 1/64 | 6 |
| | | | | | | | | | | |
| HAMADA14 | Hamada | E47-2 | M | 483 | 35 | 0.5 | 19 1/64 | 1 3/8 | 1/64 | 13 |
| HAMADA07 | Hamada | 700 CDX Main Head (rubber) | E | 484 | 45 | 5.0 | 19 3/64 | 1 49/64 | 13/64 | 13 |
| HAMADA62 | Hamada | ALPHA 248 | M | 518 | 42 | 0.5 | 20 25/64 | 1 21/32 | 1/64 | 14 |
| HAMADA10 | Hamada | 800 CDX | E | 544 | 45 | 5.0 | 21 27/64 | 1 49/64 | 13/64 | 14 |
| HAMADA60 | Hamada | ALPHA 66 | E | 710 | 51 | 5.0 | 27 61/64 | 2 | 13/64 | 11 |
| ITEK | | | | | | | | | | |
| ITEK01 | Itek | 975/985/3985 | E | 355 | 40 | 5.0 | 13 31/32 | 1 37/64 | 13/64 | 6 |
| KBA | | | | | | | | | | |
| KBA54 | KBA | Performa 66 | P | 710 | 24 | 3.0 | 27 61/64 | 15/16 | 1/8 | 0 |
| KBA02 | KBA | SRO | P | 770 | 50 | 1.0 | 30 5/16 | 1 31/32 | 3/64 | 8 |
| KBA01 | KBA | SRO (old model) | M | 770 | 50 | 0.5 | 30 5/16 | 1 31/32 | 1/64 | 8 |
| KBA37 | KBA | Rapida 74 | P | 780 | 40 | 1.0 | 30 45/64 | 1 37/64 | 3/64 | 0 |
| KBA05 | KBA | Rapida 72 | M | 780 | 46 | 0.5 | 30 45/64 | 1 13/16 | 1/64 | 11 |
| KBA19 | KBA | Performa 74 | P | 803 | 24 | 2.0 | 31 39/64 | 15/16 | 5/64 | 0 |
| KBA36 | KBA | Performa 74 | E | 803 | 24 | 3.0 | 31 39/64 | 29/32 | 1/8 | 0 |
| KBA15 | KBA | Rapida 75 | E | 815 | 24 | 3.0 | 32 3/32 | 15/16 | 1/8 | 0 |
| KBA16 | KBA | Rapida 75 | P | 815 | 24 | 3.0 | 32 3/32 | 15/16 | 1/8 | 0 |
| KBA03 | KBA | Rapida 104 (narrow) | M | 1130 | 46 | 0.5 | 44 31/64 | 1 13/16 | 1/64 | 0 |
| KBA04 | KBA | Rapida 104 (wide) | M | 1130 | 51 | 0.5 | 44 31/64 | 2 | 1/64 | 0 |
| KBA06 | KBA | Rapida 104 (wide) | M | 1130 | 51 | 0.5 | 44 31/64 | 2 | 1/64 | 12 |
| KBA18 | KBA | Rapida 105 | P | 1140 | 45 | 2.0 | 44 7/8 | 1 49/64 | 5/64 | 0 |
| KBA10 | KBA | Rapida 105 | M | 1140 | 46 | 0.5 | 44 7/8 | 1 13/16 | 1/64 | 0 |
| KBA07 | KBA | Rapida 105 | M | 1140 | 55 | 0.5 | 44 7/8 | 2 11/64 | 1/64 | 11 |
| KBA12 | KBA | Rapida 105 | P | 1160 | 35 | 2.0 | 45 21/32 | 1 3/8 | 5/64 | 0 |
| KBA17 | KBA | Rapida 105 | M | 1160 | 46 | 0.5 | 45 21/32 | 1 13/16 | 1/64 | 0 |
| KBA38 | KBA | Rapida 106 | M | 1160 | 38 | 0.5 | 45 21/32 | 1 1/2 | 1/64 | 0 |
| KBA20 | KBA | Rapida 106 | M | 1160 | 43 | 0.5 | 45 21/32 | 1 11/16 | 1/64 | 0 |
| KBA13 | KBA | Rapida 106 | P | 1160 | 43 | 1.0 | 45 21/32 | 1 11/16 | 3/64 | 0 |
| KBA11 | KBA | Rapida 142 Note: L: 1510 (our standard) | M | 1510 | 65 | 0.5 | 59 29/64 | 2 9/16 | 1/64 | 17 |
| KBA55 | KBA | Rapida 145 Prensa (P/N P7817891) | M | 1540 | 60 | 0.5 | 60 5/8 | 2 23/64 | 1/64 | 0 |
| KBA08 | KBA | Rapida 160 | M | 1540 | 65 | 0.5 | 60 5/8 | 2 9/16 | 1/64 | 19 |
| KBA39 | KBA | Metal Star | M | 1540 | 56 | 0.5 | 60 5/8 | 2 13/64 | 1/64 | 0 |
| KBA09 | KBA | Rapida 162 | M | 1710 | 65 | 0.5 | 67 21/64 | 2 9/16 | 1/64 | 19 |
| KBA22 | KBA | Rapida 164/165 | M | 1740 | 56 | 0.5 | 68 1/2 | 2 13/64 | 1/64 | 0 |
| KBA WEB | | | | | | | | | | |
| KBA27 | KBA | Compacta 215 | M | 1092 | 71 | 0.5 | 43 | 2 51/64 | 1/64 | 0 |
| KBA47 | KBA | Commander | M | 1519 | 95 | 0.5 | 59 51/64 | 3 47/64 | 1/64 | 9 |
| KBA21 | KBA | Commander | M | 1630 | 70 | 0.5 | 64 11/64 | 2 3/4 | 1/64 | 10 |
| KOMORI | | | | | | | | | | |
| KOMORI38 | Komori | Lithrone 20 Flexi | M | 580 | 48 | 0.5 | 22 53/64 | 1 57/64 | 1/64 | 8 |
| KOMORI01 | Komori | Lithrone 20 Rigid | M | 590 | 37 | 2.0 | 23 15/64 | 1 29/64 | 5/64 | 5 |
| KOMORI07 | Komori | Lithrone 26 A/W Narrow | M | 700 | 42 | 0.5 | 27 9/16 | 1 21/32 | 1/64 | 10 |
| KOMORI02 | Komori | Sprint 710 Flexi | M | 710 | 42 | 0.5 | 27 61/64 | 1 21/32 | 1/64 | 6 |
| KOMORI22 | Komori | Sprint 710 Rigid | M | 710 | 42 | 2.0 | 27 61/64 | 1 21/32 | 5/64 | 6 |
| KOMORI03 | Komori | Sprint 715 Flexi | M | 715 | 50 | 0.5 | 28 5/32 | 1 31/32 | 1/64 | 6 |
| KOMORI32 | Komori | Sprint 715 Rigid | M | 715 | 50 | 2.0 | 28 5/32 | 1 31/32 | 5/64 | 6 |
| KOMORI08 | Komori | Lithrone 26 A/W (Wide) | M | 716 | 47 | 0.5 | 28 3/16 | 1 27/32 | 1/64 | 10 |
| KOMORI04 | Komori | Sprint 719 Flexi | M | 719 | 44 | 0.5 | 28 5/16 | 1 47/64 | 1/64 | 6 |

Legend: **M** = Metal with Rubber **P** = Plastic **E** = EPDM Rubber **C** = Combination **T** = Tufnol **B** = Brass **H** = Narrow Profile

| KOMORI | | | | MM | | | INCHES | | | |
|-----------|---------|---|------|--------|-------|-----|----------|---------|-------|----------|
| Part No | Machine | Model | Type | Length | Width | Thk | Length | Width | Thk | No Holes |
| KOMORI05 | Komori | Lithrone 26 Flexi | M | 726 | 36 | 0.5 | 28 37/64 | 1 27/64 | 1/64 | 6 |
| KOMORI06 | Komori | Lithrone 26 Rigid [p/n 261-4603-402] | M | 726 | 36 | 2.0 | 28 37/64 | 1 27/64 | 5/64 | 6 |
| KOMORI36 | Komori | Lithrone 26 Flexi | M | 726 | 50 | 0.5 | 28 37/64 | 1 31/32 | 1/64 | 0 |
| KOMORI60 | Komori | Lithrone 26 - Lithrone 526 | M | 726 | 42 | 0.5 | 28 37/64 | 1 21/32 | 1/64 | 6 |
| KOMORI51 | Komori | Lithrone LS 26 | P | 730 | 35 | 1.0 | 28 47/64 | 1 3/8 | 3/64 | 10 |
| KOMORI52 | Komori | Lithrone LS 26 | M | 730 | 35 | 0.5 | 28 47/64 | 1 3/8 | 1/64 | 10 |
| KOMORI12 | Komori | Lithrone 28 A/W | P | 765 | 47 | 5.0 | 30 1/8 | 1 27/32 | 13/64 | 11 |
| KOMORI11 | Komori | Lithrone 28 A/W | M | 766 | 47 | 0.5 | 30 5/32 | 1 27/32 | 1/64 | 11 |
| KOMORI42 | Komori | Lithrone 28 [p/n 274-4629-401] | M | 775 | 47 | 0.5 | 30 33/64 | 1 27/32 | 1/64 | 11 |
| KOMORI75 | Komori | Lithrone 28 | M | 780 | 42 | 0.5 | 30 45/64 | 1 21/32 | 1/64 | 9 |
| KOMORI09 | Komori | Lithrone 28 Flexi | M | 785 | 42 | 0.5 | 30 29/32 | 1 21/32 | 1/64 | 6 |
| KOMORI10 | Komori | Lithrone 28 Rigid | M | 785 | 37 | 2.0 | 30 29/32 | 1 29/64 | 5/64 | 6 |
| KOMORI37 | Komori | Lithrone 28 Flexi new style | M | 785 | 37 | 0.5 | 30 29/32 | 1 29/64 | 1/64 | 6 |
| KOMORI45 | Komori | Spica 29 | M | 805 | 47 | 0.5 | 31 11/16 | 1 27/32 | 1/64 | 11 |
| KOMORI76 | Komori | Spica 29 | P | 805 | 47 | 5.0 | 31 11/16 | 1 27/32 | 13/64 | 11 |
| KOMORI77 | Komori | Spica 29 [p/n 345-4500-301] | P | 806 | 38 | 1.0 | 31 47/64 | 1 1/2 | 3/64 | 11 |
| KOMORI78 | Komori | Lithrone LS29 | P | 820 | 35 | 1.0 | 32 9/32 | 1 3/8 | 3/64 | 11 |
| KOMORI24 | Komori | SX29 | E | 826 | 36 | 5.0 | 32 33/64 | 1 27/64 | 13/64 | 11 |
| KOMORI107 | Komori | L32 | P | 889 | 34 | 1.0 | 35 | 1 11/32 | 3/64 | 12 |
| KOMORI53 | Komori | L32 | M | 892 | 43 | 0.5 | 35 1/8 | 1 11/16 | 1/64 | 6 |
| KOMORI43 | Komori | L32 | M | 892 | 47 | 0.5 | 35 1/8 | 1 27/32 | 1/64 | 12 |
| KOMORI13 | Komori | | P | 1010 | 35 | 1.0 | 39 49/64 | 1 3/8 | 3/64 | 13 |
| KOMORI44 | Komori | L37 | P | 1016 | 36 | 1.0 | 40 | 1 27/64 | 3/64 | 13 |
| KOMORI90 | Komori | | M | 1035 | 50 | 0.5 | 40 3/4 | 1 31/32 | 1/64 | 12 |
| KOMORI91 | Komori | Lithrone LS40SP [p/n 7144600100] | P | 1045 | 50 | 1.0 | 41 9/64 | 1 31/32 | 3/64 | 14 |
| KOMORI89 | Komori | Lithrone L38S | M | 1058 | 48 | 0.5 | 41 5/8 | 1 57/64 | 1/64 | 15 |
| KOMORI61 | Komori | Lithrone 40 | P | 1067 | 47 | 5.0 | 42 | 1 27/32 | 13/64 | 15 |
| KOMORI62 | Komori | Lithrone 40 | M | 1067 | 47 | 0.5 | 42 | 1 27/32 | 1/64 | 15 |
| KOMORI55 | Komori | Lithrone 40 A/W | M | 1077 | 42 | 0.5 | 42 13/32 | 1 21/32 | 1/64 | 15 |
| KOMORI31 | Komori | L40 A/W (Old - 47mm wide) | M | 1077 | 47 | 0.5 | 42 13/32 | 1 27/32 | 1/64 | 15 |
| KOMORI103 | Komori | Lithrone 40 GL Standard model | P | 1085 | 50 | 1.0 | 42 23/32 | 1 63/64 | 3/64 | 15 |
| KOMORI63 | Komori | Lithrone 40 | M | 1090 | 43 | 0.5 | 42 29/32 | 1 11/16 | 1/64 | 15 |
| KOMORI64 | Komori | Lithrone 40 (Oval holes) | M | 1090 | 47 | 0.5 | 42 29/32 | 1 27/32 | 1/64 | 15 |
| KOMORI28 | Komori | Lithrone 40 A/W | P | 1094 | 47 | 5.0 | 43 5/64 | 1 27/32 | 13/64 | 8 |
| KOMORI14 | Komori | Lithrone 40 Flexi | M | 1094 | 50 | 0.5 | 43 5/64 | 1 63/64 | 1/64 | 8 |
| KOMORI15 | Komori | Lithrone 40 Rigid | M | 1094 | 50 | 2.0 | 43 5/64 | 1 63/64 | 5/64 | 8 |
| KOMORI16 | Komori | Lithrone 40 A/W | P | 1094 | 50 | 5.0 | 43 5/64 | 1 31/32 | 13/64 | 8 |
| KOMORI29 | Komori | Lithrone 40 A/W | P | 1094 | 50 | 5.0 | 43 5/64 | 1 31/32 | 13/64 | 15 |
| KOMORI65 | Komori | Lithrone 40 | M | 1098 | 52 | 0.5 | 43 15/64 | 2 3/64 | 1/64 | 15 |
| KOMORI66 | Komori | Lithrone 40 | P | 1098 | 50 | 1.0 | 43 15/64 | 1 31/32 | 3/64 | 15 |
| KOMORI40 | Komori | Lithrone GL40 | P | 1100 | 35 | 1.0 | 43 5/16 | 1 3/8 | 3/64 | 15 |
| KOMORI67 | Komori | Lithrone 40 | M | 1105 | 50 | 0.5 | 43 1/2 | 1 31/32 | 1/64 | 15 |
| KOMORI48 | Komori | Lithrone 40 | P | 1106 | 50 | 1.0 | 43 35/64 | 1 31/32 | 3/64 | 15 |
| KOMORI30 | Komori | L40 AW (Old 47mm wide) [p/n 444-4254-064] | M | 1110 | 47 | 0.5 | 43 45/64 | 1 27/32 | 1/64 | 15 |
| KOMORI47 | Komori | Lithrone S40 (New model) | P | 1110 | 47 | 1.0 | 43 45/64 | 1 27/32 | 3/64 | 15 |
| KOMORI68 | Komori | L40 AW (Old 47mm wide) | P | 1110 | 47 | 5.0 | 43 45/64 | 1 27/32 | 13/64 | 15 |
| KOMORI41 | Komori | Lithrone 40 A/W | P | 1111 | 50 | 1.0 | 43 47/64 | 1 31/32 | 3/64 | 15 |
| KOMORI104 | Komori | Lithrone GLX40 | P | 1116 | 50 | 1.0 | 43 15/16 | 1 31/32 | 3/64 | 15 |
| KOMORI105 | Komori | Lithrone LS44SP | P | 1150 | 50 | 1.0 | 45 9/32 | 1 31/32 | 3/64 | 16 |
| KOMORI56 | Komori | Lithrone LS44SP (Upper) [p/n 7244601501] | P | 1165 | 50 | 1.0 | 45 55/64 | 1 31/32 | 3/64 | 16 |
| KOMORI79 | Komori | Lithrone 44 | M | 1178 | 47 | 0.5 | 46 3/8 | 1 27/32 | 1/64 | 17 |
| KOMORI39 | Komori | Lithrone 44 | M | 1190 | 50 | 2.0 | 46 27/32 | 1 31/32 | 5/64 | 9 |

Legend: **M** = Metal with Rubber **P** = Plastic **E** = EPDM Rubber **C** = Combination **T** = Tufnol **B** = Brass **H** = Narrow Profile

| KOMORI | | | | MM | | | INCHES | | | |
|--------------|--------------|--|------|--------|-------|-----|----------|---------|-------|----------|
| Part No | Machine | Model | Type | Length | Width | Thk | Length | Width | Thk | No Holes |
| KOMORI71 | Komori | Lithrone 44 SP (p/n 4644047064) | M | 1210 | 47 | 0.5 | 47 41/64 | 1 27/32 | 1/64 | 17 |
| KOMORI106 | Komori | Lithrone 44 SP | P | 1210 | 50 | 1.0 | 47 41/64 | 1 31/32 | 3/64 | 17 |
| KOMORI57 | Komori | Lithrone LS44 (Lower) (p/n 7244650801) | P | 1230 | 50 | 1.0 | 48 27/64 | 1 31/32 | 3/64 | 17 |
| KOMORI99 | Komori | Lithrone 50 (min qty 4 pieces) | M | 1380 | 42 | 0.5 | 54 21/64 | 1 21/32 | 1/64 | 19 |
| KOMORI WEB | | | | | | | | | | |
| KOMORI83 | Komori | System 35 (Web 16 pages) | M | 960 | 50 | 0.5 | 37 51/64 | 1 31/32 | 1/64 | 13 |
| KOMORI93 | Komori | System 38 | M | 1040 | 56 | 0.5 | 40 15/16 | 2 3/16 | 1/64 | 11 |
| MAN | | | | | | | | | | |
| MAN01 | MAN/Roland | Rotoman 8 | M | 1038 | 65 | 0.5 | 40 55/64 | 2 9/16 | 1/64 | 10 |
| MAN07 | MAN/Roland | Rotoman 70 | M | 1040 | 65 | 0.5 | 40 15/16 | 2 9/16 | 1/64 | 6 |
| MAN10 | MAN/Roland | Lithoman Duplex | M | 1156 | 65 | 0.5 | 45 33/64 | 2 9/16 | 1/64 | 6 |
| MAN12 | MAN/Roland | Colorman | M | 1730 | 65 | 0.5 | 68 7/64 | 2 9/16 | 1/64 | 9 |
| MAN15 | MAN/Roland | Rotoman | M | 1766 | 64 | 0.5 | 69 17/32 | 2 33/64 | 1/64 | 11 |
| MAN11 | MAN/Roland | Lithoman | M | 2060 | 65 | 0.5 | 81 3/32 | 2 9/16 | 1/64 | 11 |
| MILLER | | | | | | | | | | |
| MILLER01 | Miller | TP 29/TP 74 | M | 826 | 67 | 0.5 | 32 33/64 | 2 41/64 | 1/64 | 8 |
| MILLER06 | Miller | TP 32 | M | 920 | 67 | 0.5 | 36 7/32 | 2 41/64 | 1/64 | 9 |
| MILLER02 | Miller | TP 36/92/93/94 | M | 1020 | 67 | 0.5 | 40 5/32 | 2 41/64 | 1/64 | 10 |
| MILLER04 | Miller | TP 38 | M | 1092 | 76 | 0.5 | 43 | 3 | 1/64 | 10 |
| MILLER03 | Miller | TP 41/TP 104 | M | 1140 | 67 | 0.5 | 44 7/8 | 2 41/64 | 1/64 | 12 |
| MITSUBISHI | | | | | | | | | | |
| MITSUBISHI22 | Mitsubishi | 1F | P | 776 | 28 | 3.0 | 30 35/64 | 1 7/64 | 1/8 | 9 |
| MITSUBISHI19 | Mitsubishi | 1E/1F | M | 778 | 33 | 0.5 | 30 5/8 | 1 19/64 | 1/64 | 9 |
| MITSUBISHI08 | Mitsubishi | 1E | P | 784 | 40 | 2.0 | 30 55/64 | 1 37/64 | 5/64 | 8 |
| MITSUBISHI07 | Mitsubishi | 1E/1F/1G w/slots (cntr/cntr 104mm) | M | 785 | 40 | 0.5 | 30 29/32 | 1 37/64 | 1/64 | 8 |
| MITSUBISHI12 | Mitsubishi | 1E | M | 785 | 40 | 0.5 | 30 29/32 | 1 37/64 | 1/64 | 8 |
| MITSUBISHI14 | Mitsubishi | 1G | M | 785 | 37 | 0.5 | 30 29/32 | 1 29/64 | 1/64 | 8 |
| MITSUBISHI42 | Mitsubishi | 1E/1F/1G w/holes (cntr/cntr 104mm) | M | 785 | 40 | 0.5 | 30 29/32 | 1 37/64 | 1/64 | 8 |
| MITSUBISHI30 | Mitsubishi | 2F | M | 882 | 40 | 0.5 | 34 23/32 | 1 37/64 | 1/64 | 9 |
| MITSUBISHI16 | Mitsubishi | 3F/Diamond | M | 1080 | 35 | 0.5 | 42 33/64 | 1 3/8 | 1/64 | 11 |
| MITSUBISHI02 | Mitsubishi | 3F | P | 1090 | 45 | 2.0 | 42 29/32 | 1 49/64 | 5/64 | 11 |
| MITSUBISHI40 | Mitsubishi | 3F/G | M | 1090 | 40 | 0.5 | 42 29/32 | 1 37/64 | 1/64 | 11 |
| MITSUBISHI06 | Mitsubishi | 3F/3G/Diamond 3000 | M | 1095 | 40 | 0.5 | 43 7/64 | 1 37/64 | 1/64 | 11 |
| MITSUBISHI34 | Mitsubishi | 3F/3G/Diamond 3000 | P | 1095 | 40 | 1.0 | 43 7/64 | 1 37/64 | 3/64 | 11 |
| MITSUBISHI41 | Mitsubishi | 3/H/F/Diamond 3000 | M | 1100 | 40 | 0.5 | 43 5/16 | 1 37/64 | 1/64 | 11 |
| MITSUBISHI29 | Mitsubishi | 3000 | M | 1126 | 40 | 0.5 | 44 21/64 | 1 37/64 | 1/64 | 11 |
| MITSUBISHI17 | Mitsubishi | 3F | M | 1186 | 40 | 0.5 | 46 11/16 | 1 37/64 | 1/64 | 11 |
| MITSUBISHI15 | Mitsubishi | 5F | M | 1366 | 42 | 0.5 | 53 25/32 | 1 21/32 | 1/64 | 13 |
| MITSUBISHI44 | Mitsubishi | Daya 5ID (MOQ 10pcs) | P | 1400 | 45 | 2.0 | 55 1/8 | 1 49/64 | 5/64 | 21 |
| MITSUBISHI20 | Mitsubishi | 6F/6G | M | 1506 | 40 | 0.5 | 59 19/64 | 1 37/64 | 1/64 | 14 |
| MITSUBISHI26 | Mitsubishi | Web Press | M | 947 | 60 | 0.5 | 37 9/32 | 2 23/64 | 1/64 | 10 |
| MITSUBISHI45 | Mitsubishi | Lithopia BT2 Web Press | P | 990 | 55 | 1.0 | 39 | 2 11/64 | 3/64 | 11 |
| MITSUBISHI47 | Mitsubishi | Lithopia BT2 Web Press | M | 990 | 55 | 0.5 | 39 | 2 11/64 | 1/64 | 11 |
| MITSUBISHI46 | Mitsubishi | Lithopia Web Press | P | 1100 | 60 | 1.0 | 43 5/16 | 2 23/64 | 3/64 | 13 |
| MIYAKOSHI | | | | | | | | | | |
| MIYAKOSHI20 | Miyakoshi | MV-18B-NI | E | 525 | 56 | 5.0 | 20 43/64 | 2 13/64 | 13/64 | 12 |
| MIYAKOSHI21 | Miyakoshi | MV-DVF-20 | E | 584 | 55 | 5.0 | 23 | 2 11/64 | 13/64 | 10 |
| MULLER | | | | | | | | | | |
| MULLER06 | Muller Mart. | Pronto 2200 Model 42 | M | 459 | 37 | 0.5 | 18 5/64 | 1 29/64 | 1/64 | 5 |
| MULLER02 | Muller Mart. | O Type/ Concept A/ Progress | M | 529 | 37 | 0.5 | 20 53/64 | 1 29/64 | 1/64 | 6 |
| MULLER11 | Muller Mart. | Grapha 50 | M | 530 | 47 | 0.5 | 20 55/64 | 1 27/32 | 1/64 | 6 |
| MULLER18 | Muller Mart. | | M | 559 | 37 | 0.5 | 22 1/64 | 1 29/64 | 1/64 | 6 |

Legend: **M** = Metal with Rubber **P** = Plastic **E** = EPDM Rubber **C** = Combination **T** = Tufnol **B** = Brass **H** = Narrow Profile

| MULLER | | | | MM | | | INCHES | | | | |
|------------|--|---|--------|--------|-------|-----|----------|----------|---------|----------|-----|
| Part No | Machine | Model | Type | Length | Width | Thk | Length | Width | Thk | No Holes | |
| MULLER19 | Muller Mart. | | M | 694 | 37 | 0.5 | 27 21/64 | 1 29/64 | 1/64 | 8 | |
| MULLER15 | Muller Mart. | Grapha 40 | M | 834 | 37 | 0.5 | 32 53/64 | 1 29/64 | 1/64 | 10 | |
| MULLER23 | Muller Mart. | VSOP 850 [2722.2627.3] | M | 930 | 37 | 0.5 | 36 39/64 | 1 29/64 | 1/64 | 10 | |
| NILPETER | | | | | | | | | | | |
| NILPETER01 | Nilpeter | Nilpeter B200 | E | 240 | 25 | 5.0 | 9 29/64 | 63/64 | 13/64 | 0 | |
| NILPETER02 | Nilpeter | Nilpeter B280 | E | 335 | 25 | 5.0 | 13 3/16 | 63/64 | 13/64 | 0 | |
| OLIVER | | | | | | | | | | | |
| OLIVER01 | Oliver | 6 & 48 | 5.0 mm | E | 525 | 50 | 5.0 | 20 43/64 | 1 31/32 | 13/64 | 7 |
| OLIVER02 | Oliver | 52 | | E | 566 | 50 | 5.0 | 22 9/32 | 1 31/32 | 13/64 | 8 |
| OLIVER03 | Oliver | 58 | | E | 621 | 50 | 5.0 | 24 29/64 | 1 31/32 | 13/64 | 9 |
| OLIVER05 | Oliver | 66 EZ | | E | 717 | 50 | 5.0 | 28 15/64 | 1 31/32 | 13/64 | 10 |
| OLIVER04 | Oliver | 66 | | E | 730 | 50 | 5.0 | 28 47/64 | 1 31/32 | 13/64 | 9 |
| OLIVER06 | Oliver | 72 | | E | 790 | 50 | 5.0 | 31 7/64 | 1 31/32 | 13/64 | 10 |
| | First determine if you need 3.0 or 5.0mm rubber blades | | | | | | | | | | |
| OLIVER12 | Oliver | 52 (original specs) | 3.0 mm | E | 566 | 50 | 3.0 | 22 9/32 | 1 31/32 | 1/8 | 8 |
| OLIVER13 | Oliver | 58 (original specs) | | E | 621 | 50 | 3.0 | 24 29/64 | 1 31/32 | 1/8 | 9 |
| OLIVER15 | Oliver | 66 EZ (original specs) | | E | 717 | 50 | 3.0 | 28 15/64 | 1 31/32 | 1/8 | 10 |
| OLIVER14 | Oliver | 66 | | E | 730 | 50 | 3.0 | 28 47/64 | 1 31/32 | 1/8 | 9 |
| OLIVER19 | Oliver | 66 SD (original specs - for 43mm width) | | E | 760 | 43 | 3.0 | 29 59/64 | 1 11/16 | 1/8 | 9 |
| OLIVER20 | Oliver | 66 SD | | M | 760 | 43 | 0.5 | 29 59/64 | 1 11/16 | 1/64 | 9 |
| OLIVER24 | Oliver | 66 SD (original specs - for 50mm width) | | E | 762 | 50 | 3.0 | 30 | 1 31/32 | 1/8 | 9 |
| OLIVER16 | Oliver | 72 (original specs) | | E | 790 | 50 | 3.0 | 31 7/64 | 1 31/32 | 1/8 | 10 |
| OLIVER17 | Oliver | 82 (original specs) | | E | 870 | 50 | 3.0 | 34 1/4 | 1 31/32 | 1/8 | 11 |
| OLIVER21 | Oliver | 75 SD (original specs) | | E | 880 | 49 | 3.0 | 34 41/64 | 1 59/64 | 1/8 | 11 |
| OLIVER22 | Oliver | 75 SD (original specs) | | M | 880 | 49 | 0.5 | 34 41/64 | 1 59/64 | 1/64 | 11 |
| OLIVER18 | Oliver | 94 (original specs) | | E | 987 | 50 | 3.0 | 38 55/64 | 1 31/32 | 1/8 | 12 |
| OMEC | | | | | | | | | | | |
| OMEC01 | Omec | Omec | | M | 595 | 30 | 0.5 | 23 27/64 | 1 3/16 | 1/64 | 6 |
| PLANETA | | | | | | | | | | | |
| PLANETA02 | Planeta | 4E Super Variant - 4-6 - Standard | | P | 1060 | 60 | 5.0 | 41 47/64 | 2 23/64 | 13/64 | 9 |
| PLANETA01 | Planeta | Varimat | | M | 1150 | 68 | 0.5 | 45 9/32 | 2 43/64 | 1/64 | 13 |
| PLANETA05 | Planeta | 6 standard (clear, soft plastic) | | P | 1350 | 60 | 5.0 | 53 9/64 | 2 23/64 | 13/64 | 15 |
| PLANETA04 | Planeta | 7 (clear, soft plastic) | | P | 1510 | 60 | 5.0 | 59 29/64 | 2 23/64 | 13/64 | 15 |
| POGO | | | | | | | | | | | |
| POGO1 | POGO | 2-84-441-P | | P | 950 | 80 | 1.0 | 37 13/32 | 3 5/32 | 3/64 | 8 |
| ROLAND | | | | | | | | | | | |
| PRAKTIKA51 | Roland | Praktika 00 | | M | 557 | 67 | 0.5 | 21 59/64 | 2 41/64 | 1/64 | 6 |
| PRAKTIKA53 | Roland | Praktika 01 | | M | 705 | 67 | 0.5 | 27 3/4 | 2 41/64 | 1/64 | 7 |
| | | | | | | | | | | | |
| ROLAND01 | Roland | Formall/Junior Print | | M | 415 | 60 | 0.5 | 16 11/32 | 2 23/64 | 1/64 | 5+4 |
| ROLAND02 | Roland | 100 | | M | 705 | 65 | 0.5 | 27 3/4 | 2 9/16 | 1/64 | 7 |
| ROLAND24 | Roland | 100 (w/slots) | | M | 726 | 65 | 0.5 | 28 37/64 | 2 9/16 | 1/64 | 9 |
| ROLAND03 | Roland | Favorit RF01 | | M | 720 | 65 | 0.5 | 28 11/32 | 2 9/16 | 1/64 | 8 |
| ROLAND04 | Roland | 200 (Pre No 235) | | M | 785 | 65 | 0.5 | 30 29/32 | 2 9/16 | 1/64 | 8 |
| ROLAND34 | Roland | 200 | | P | 790 | 60 | 1.0 | 31 7/64 | 2 23/64 | 3/64 | 8 |
| ROLAND05 | Roland | Favorit RFOB/02/200 | | M | 800 | 65 | 0.5 | 31 1/2 | 2 9/16 | 1/64 | 8 |
| ROLAND06 | Roland | 300 | | P | 816 | 60 | 1.0 | 32 1/8 | 2 23/64 | 3/64 | 8 |
| ROLAND62 | Roland | 300 | | M | 816 | 60 | 0.5 | 32 1/8 | 2 23/64 | 1/64 | 8 |
| ROLAND35 | Roland | 500 [80.07V30-A078/AK] | | P | 818 | 60 | 1.0 | 32 13/64 | 2 23/64 | 3/64 | 8 |
| ROLAND36 | Roland | 500 | | P | 818 | 40 | 1.0 | 32 13/64 | 1 37/64 | 3/64 | 0 |
| ROLAND07 | Roland | Parva RP1 | | M | 900 | 65 | 0.5 | 35 7/16 | 2 9/16 | 1/64 | 9 |
| ROLAND08 | Roland | Parva RP/RZP2 | | M | 920 | 65 | 0.5 | 36 7/32 | 2 9/16 | 1/64 | 10 |

Legend: **M** = Metal with Rubber **P** = Plastic **E** = EPDM Rubber **C** = Combination **T** = Tufnol **B** = Brass **H** = Narrow Profile

| ROLAND | | | | MM | | | INCHES | | | |
|-------------|-----------|------------------------------------|------|--------|-------|-----|----------|---------|-------|----------|
| Part No | Machine | Model | Type | Length | Width | Thk | Length | Width | Thk | No Holes |
| ROLAND09 | Roland | Parva RP2C | M | 995 | 65 | 0.5 | 39 11/64 | 2 9/16 | 1/64 | 10 |
| ROLAND10 | Roland | Rekord 3 | M | 1042 | 65 | 0.5 | 41 1/64 | 2 9/16 | 1/64 | 11 |
| ROLAND11 | Roland | Rekord RVK 3B | M | 1075 | 65 | 0.5 | 42 21/64 | 2 9/16 | 1/64 | 11 |
| ROLAND12 | Roland | Rekord RZK 3B and 604 (lower unit) | M | 1100 | 65 | 0.5 | 43 5/16 | 2 9/16 | 1/64 | 11 |
| ROLAND13 | Roland | Rekord RWK 3B | M | 1132 | 65 | 0.5 | 44 9/16 | 2 9/16 | 1/64 | 12 |
| | | | | | | | | | | |
| ROLAND63 | Roland | 600 (upper) | M | 1090 | 65 | 0.5 | 42 29/32 | 2 9/16 | 1/64 | 11 |
| ROLAND64 | Roland | 600 (lower) same as code: ROLAND12 | M | 1100 | 65 | 0.5 | 43 5/16 | 2 9/16 | 1/64 | 11 |
| ROLAND14 | Roland | 700 (old) | M | 1091 | 56 | 0.5 | 42 61/64 | 2 13/64 | 1/64 | 13 |
| ROLAND15 | Roland | 700 (new) | M | 1100 | 56 | 0.5 | 43 5/16 | 2 13/64 | 1/64 | 13 |
| ROLAND26 | Roland | 700 (new model + w/slots) | M | 1100 | 56 | 0.5 | 43 5/16 | 2 13/64 | 1/64 | 13 |
| ROLAND25 | Roland | 700 (007V143930) | P | 1102 | 56 | 1.0 | 43 25/64 | 2 13/64 | 3/64 | 13 |
| ROLAND28 | Roland | 700 (new model + no holes) | M | 1105 | 40 | 0.5 | 43 1/2 | 1 37/64 | 1/64 | 0 |
| ROLAND38 | Roland | 700 (007V172730) | P | 1108 | 40 | 1.0 | 43 5/8 | 1 37/64 | 3/64 | 0 |
| ROLAND39 | Roland | 700 (007V172730) (3mm) | P | 1108 | 40 | 3.0 | 43 5/8 | 1 37/64 | 1/8 | 0 |
| ROLAND16 | Roland | Ultra 4 (1st) | M | 1145 | 65 | 0.5 | 45 5/64 | 2 9/16 | 1/64 | 11 |
| ROLAND17 | Roland | Ultra 4 (2nd) | M | 1195 | 65 | 0.5 | 47 3/64 | 2 9/16 | 1/64 | 11 |
| ROLAND42 | Roland | Ultra 4 (2nd) | M | 1195 | 65 | 0.5 | 47 3/64 | 2 9/16 | 1/64 | 0 |
| ROLAND18 | Roland | Ultra V | M | 1335 | 65 | 0.5 | 52 9/16 | 2 9/16 | 1/64 | 13 |
| ROLAND37 | Roland | Ultra V | M | 1335 | 65 | 0.5 | 52 9/16 | 2 9/16 | 1/64 | 0 |
| ROLAND19 | Roland | Ultra VI | M | 1475 | 65 | 0.5 | 58 5/64 | 2 9/16 | 1/64 | 14 |
| ROLAND43 | Roland | Ultra VI | M | 1475 | 65 | 0.5 | 58 5/64 | 2 9/16 | 1/64 | 0 |
| ROLAND20 | Roland | Ultra VII & VIIB | M | 1675 | 65 | 0.5 | 65 15/16 | 2 9/16 | 1/64 | 16 |
| ROLAND21 | Roland | Ultra VII & VIIB | M | 1710 | 65 | 0.5 | 67 21/64 | 2 9/16 | 1/64 | 16 |
| ROLAND22 | Roland | 800 V/VW w/slots | M | 1410 | 65 | 0.5 | 55 33/64 | 2 9/16 | 1/64 | 13 |
| ROLAND23 | Roland | 800 VI | M | 1510 | 65 | 0.5 | 59 29/64 | 2 9/16 | 1/64 | 14 |
| ROLAND29 | Roland | 900 | M | 1410 | 60 | 0.5 | 55 33/64 | 2 23/64 | 1/64 | 14 |
| ROLAND65 | Roland | 900 | P | 1410 | 40 | 1.0 | 55 33/64 | 1 37/64 | 3/64 | 0 |
| ROLAND68 | Roland | 900 | P | 1524 | 40 | 1.0 | 60 | 1 37/64 | 3/64 | 0 |
| ROLAND27 | Roland | 900 (07V146730) | P | 1529 | 60 | 1.0 | 60 13/64 | 2 23/64 | 3/64 | 16 |
| ROLAND31 | Roland | 900 | M | 1529 | 60 | 0.5 | 60 13/64 | 2 23/64 | 1/64 | 16 |
| ROTAPRINT | | | | | | | | | | |
| ROTAPRINT01 | Rotaprint | R45K | P | 295 | 28 | 1.0 | 11 39/64 | 1 7/64 | 3/64 | 5 |
| ROTAPRINT02 | Rotaprint | R35K/R36K/R37K | P | 495 | 28 | 1.0 | 19 31/64 | 1 7/64 | 3/64 | 7 |
| ROTAPRINT10 | Rotaprint | R38/50NP - ENGLISH | E | 510 | 35 | 3.0 | 20 5/64 | 1 3/8 | 1/8 | 18 |
| ROTAPRINT04 | Rotaprint | R35KV/R36KV/R37KV | P | 538 | 28 | 1.0 | 21 3/16 | 1 7/64 | 3/64 | 7 |
| ROTATEK | | | | | | | | | | |
| ROTATEK05 | Rotatek | MP 150 | M | 442 | 58 | 0.5 | 17 13/32 | 2 9/32 | 1/64 | 5 |
| ROTATEK01 | Rotatek | 100/200/RK 200 PLUS | M | 539 | 58 | 0.5 | 21 7/32 | 2 9/32 | 1/64 | 6 |
| ROTATEK04 | Rotatek | RK PLUS | M | 545 | 60 | 0.5 | 21 29/64 | 2 23/64 | 1/64 | 6 |
| ROTATEK02 | Rotatek | 300/400 | M | 584 | 53 | 0.5 | 23 | 2 3/32 | 1/64 | 6 |
| ROTATEK03 | Rotatek | 300/400 | M | 584 | 58 | 0.5 | 23 | 2 9/32 | 1/64 | 6 |
| RYOBI | | | | | | | | | | |
| RYOBI22 | Ryobi | 2700/2800 | P | 305 | 40 | 5.0 | 12 | 1 37/64 | 13/64 | 6 |
| RYOBI01 | Ryobi | 2700/2800 | E | 305 | 40 | 5.0 | 12 | 1 37/64 | 13/64 | 6 |
| RYOBI16 | Ryobi | 3200 & 3302M (old) | P | 354 | 40 | 5.0 | 13 15/16 | 1 37/64 | 13/64 | 6 |
| RYOBI03 | Ryobi | 3200 PFA | E | 354 | 28 | 5.0 | 13 15/16 | 1 7/64 | 13/64 | 6 |
| RYOBI02 | Ryobi | 3200 & 3302M (old) | E | 355 | 40 | 5.0 | 13 31/32 | 1 37/64 | 13/64 | 6 |
| RYOBI14 | Ryobi | 3302 | E | 360 | 40 | 5.0 | 14 11/64 | 1 37/64 | 13/64 | 6 |
| RYOBI17 | Ryobi | 3304H | P | 364 | 40 | 5.0 | 14 21/64 | 1 37/64 | 13/64 | 6 |
| RYOBI20 | Ryobi | 3304H | E | 364 | 40 | 5.0 | 14 21/64 | 1 37/64 | 13/64 | 6 |
| RYOBI10 | Ryobi | 3404-DI | P | 392 | 26 | 3.0 | 15 7/16 | 1 11/32 | 1/8 | 7 |

Legend: **M** = Metal with Rubber **P** = Plastic **E** = EPDM Rubber **C** = Combination **T** = Tufnol **B** = Brass **H** = Narrow Profile

| RYOBI | | | | MM | | | INCHES | | | |
|------------------|------------------|------------------------------------|------|--------|-------|-----|----------|---------|-------|----------|
| Part No | Machine | Model | Type | Length | Width | Thk | Length | Width | Thk | No Holes |
| RYOBI04 | Ryobi | 4502-450-R/MCS | E | 453 | 41 | 5.0 | 17 53/64 | 1 39/64 | 13/64 | 6 |
| RYOBI05 | Ryobi | 480N/500N | E | 507 | 45 | 5.0 | 19 61/64 | 1 49/64 | 13/64 | 9 |
| RYOBI06 | Ryobi | 480K/480D/500K | E | 508 | 45 | 5.0 | 20 | 1 49/64 | 13/64 | 11 |
| RYOBI07 | Ryobi | 500 KNP Numbering Unit | M | 510 | 42 | 0.5 | 20 5/64 | 1 21/32 | 1/64 | 11 |
| RYOBI25 | Ryobi | 520/522/524-NP Numbering Unit | M | 545 | 47 | 0.5 | 21 29/64 | 1 27/32 | 1/64 | 6 |
| RYOBI26 | Ryobi | 510 | E | 559 | 30 | 3.0 | 22 | 1 3/16 | 1/8 | 9 |
| RYOBI08 | Ryobi | 512 | E | 560 | 28 | 5.0 | 22 3/64 | 1 7/64 | 13/64 | 9 |
| RYOBI24 | Ryobi | 512 (plastic) | P | 560 | 28 | 5.0 | 22 3/64 | 1 7/64 | 13/64 | 9 |
| RYOBI09 | Ryobi | 520/522/525 | E | 572 | 25 | 5.0 | 22 33/64 | 31/32 | 13/64 | 9 |
| RYOBI19 | Ryobi | 520/522 (plastic) | P | 572 | 25 | 5.0 | 22 33/64 | 31/32 | 13/64 | 9 |
| RYOBI12 | Ryobi | 530/560 | E | 602 | 39 | 5.0 | 23 45/64 | 1 17/32 | 13/64 | 13 |
| RYOBI18 | Ryobi | 640K | E | 736 | 47 | 5.0 | 28 31/32 | 1 27/32 | 13/64 | 16 |
| RYOBI31 | Ryobi | 784EP | P | 848 | 34 | 5.0 | 33 25/64 | 1 11/32 | 13/64 | 12 |
| RYOBI13 | Ryobi | 662 PFH | E | 760 | 40 | 5.0 | 29 59/64 | 1 37/64 | 13/64 | 11 |
| RYOBI21 | Ryobi | 750 | P | 855 | 34 | 5.0 | 33 21/32 | 1 11/32 | 13/64 | 12 |
| RYOBI27 | Ryobi | 750 | E | 855 | 34 | 5.0 | 33 21/32 | 1 11/32 | 13/64 | 12 |
| RYOBI30 | Ryobi | 920 (same as RYOBI28 only shorter) | E | 1002 | 34 | 5.0 | 39 3/8" | 1 11/32 | 13/64 | 14 |
| RYOBI23 | Ryobi | 920 | P | 1006 | 35 | 5.0 | 39 39/64 | 1 3/8 | 13/64 | 14 |
| RYOBI28 | Ryobi | 920 | E | 1006 | 34 | 5.0 | 39 39/64 | 1 11/32 | 13/64 | 14 |
| SAKURAI | | | | | | | | | | |
| SAKURAI | Refer to: OLIVER | | | | | | | | | |
| SHINOHARA | | | | | | | | | | |
| SHINOHARA | Refer to: FUJI | | | | | | | | | |
| SOLNA | | | | | | | | | | |
| SOLNA01 | Solna | 24 (plastic) | P | 695 | 52 | 1.0 | 27 23/64 | 2 3/64 | 3/64 | 9 |
| SOLNA07 | Solna | 124/224 - 125/225/425 | E | 700 | 22 | 3.0 | 27 9/16 | 55/64 | 1/8 | 0 |
| SOLNA08 | Solna | 164/566 | E | 710 | 22 | 3.0 | 27 61/64 | 55/64 | 1/8 | 0 |
| SOLNA05 | Solna | 25 | E | 730 | 19.5 | 3.0 | 28 47/64 | 49/64 | 1/8 | 0 |
| SOLNA02 | Solna | 25 | P | 732 | 19 | 1.0 | 28 13/16 | 3/4 | 3/64 | 0 |
| SOLNA13 | Solna | Distributor | E | 1088 | 45 | 3.0 | 42 53/64 | 1 49/64 | 1/8 | 15 |
| STEVENS | | | | | | | | | | |
| STEVENS02 | Stevens | Stevens | M | 578 | 50 | 0.5 | 22 3/4 | 1 31/32 | 1/64 | 6 |
| TAIYO | | | | | | | | | | |
| TAIYO02 | Taiyo | Kikai-TOF-S | E | 512 | 30 | 5.0 | 20 5/32 | 1 3/16 | 13/64 | 11 |
| TAIYO04 | Taiyo | | E | 570 | 30 | 5.0 | 22 7/16 | 1 3/16 | 13/64 | 11 |
| TIMSON | | | | | | | | | | |
| TIMSON02 | Timson | T32/40 | M | 1080 | 53 | 0.5 | 42 33/64 | 2 3/32 | 1/64 | 0 |
| TIMSON04 | Timson | T32/47 | M | 1257 | 53 | 0.5 | 49 31/64 | 2 3/32 | 1/64 | 0 |
| TIMSON05 | Timson | T32/47 | M | 1257 | 53 | 2.0 | 49 31/64 | 2 3/32 | 5/64 | 0 |
| TIMSON03 | Timson | C-T32/53 | M | 1408 | 53 | 0.5 | 55 7/16 | 2 3/32 | 1/64 | 0 |
| WIFAG | | | | | | | | | | |
| WIFAG04 | Wifag | | M | 1800 | 45 | 0.5 | 70 55/64 | 1 49/64 | 1/64 | 0 |
| WINKLER | | | | | | | | | | |
| WINKLER01 | Winkler | 212/214 | M | 475 | 46 | 2.0 | 18 45/64 | 1 13/16 | 5/64 | 5 |
| | | | | | | | | | | |
| | | | | | | | | | | |

Legend: **M** = Metal with Rubber **P** = Plastic **E** = EPDM Rubber **C** = Combination **T** = Tufnol **B** = Brass **H** = Narrow Profile

Master Rubber Suckers

*keep it
running...*

HEIDELBERG Suckers - Quick reference guide

Heidelberg Shaped Suckers

| COLOR | OUTSIDE | INSIDE | HEIGHT |
|-------|-----------------|--------------|---------------|
| Grey | 27mm 1 1/16" | 7mm 9/32" | 6mm 15/64" |

04.016.071

RS501 Packing 25pcs/pack

Heidelberg

| COLOR | OUTSIDE | INSIDE | HEIGHT |
|-------|------------------|--------------|------------------|
| Black | 15.5mm 39/64" | 4mm 5/32" | 16.5mm 21/32" |

A1.016.327/04

RS506 Packing 12pcs/pack

Heidelberg

| COLOR | OUTSIDE | INSIDE | HEIGHT |
|-------|-----------------|--------------|---------------|
| Black | 29mm 1 9/64" | 7mm 9/32" | 9mm 23/64" |

RS299 Packing 12pcs/pack

Heidelberg
Excellent for thin paper

| COLOR | OUTSIDE | INSIDE | HEIGHT |
|-------|--------------|---------------|---------------|
| Beige | 22mm 7/8" | 6mm 15/64" | 5mm 13/64" |

RS502 Packing 25pcs/pack

Heidelberg

| COLOR | OUTSIDE | INSIDE | HEIGHT |
|-------|------------------|---------------|----------------|
| Grey | 15.5mm 39/64" | 5mm 13/64" | 31mm 17/32" |

RS507 Packing 12pcs/pack

Heidelberg

| COLOR | OUTSIDE | INSIDE | HEIGHT |
|-------|----------------|----------------|----------------|
| Red | 23mm 29/32" | 12mm 15/32" | 3.5mm 9/64" |

F3.582.263/

RS511 Packing 12pcs/pack

Heidelberg

| COLOR | OUTSIDE | INSIDE | HEIGHT |
|-------|--------------|---------------|---------------|
| Beige | 22mm 7/8" | 6mm 15/64" | 5mm 13/64" |

RS502 Packing 25pcs/pack

Heidelberg

| COLOR | OUTSIDE | INSIDE | HEIGHT |
|-------|-----------------|----------------|---------------|
| Black | 28mm 1 7/64" | 17mm 43/64" | 6mm 15/64" |

66.028.405

RS508 Packing 12pcs/pack

Heidelberg

| COLOR | OUTSIDE | INSIDE | HEIGHT |
|-------|-----------------|--------------|----------------|
| Clear | 31mm 1 7/32" | 16mm 5/8" | 14mm 35/64" |

00.580.6723/02

RS512 Packing 12pcs/pack

Heidelberg

| COLOR | OUTSIDE | INSIDE | HEIGHT |
|-------|--------------|--------------|-------------|
| Red | 19mm 3/4" | 7mm 9/32" | 3mm 1/8" |

42.016.072

RS503 Packing 25pcs/pack

Heidelberg

| COLOR | OUTSIDE | INSIDE | HEIGHT |
|-------|-----------------|----------------|---------------|
| Black | 28mm 1 7/64" | 17mm 43/64" | 6mm 15/64" |

66.028.405

RS508 Packing 12pcs/pack

Heidelberg

| COLOR | OUTSIDE | INSIDE | HEIGHT |
|-------|-----------------|--------------|----------------|
| Red | 28mm 1 7/64" | 16mm 5/8" | 3.6mm 9/64" |

F6.582.263

RS513 Packing 12pcs/pack

Heidelberg

| COLOR | OUTSIDE | INSIDE | HEIGHT |
|-------|----------------|---------------|--------------|
| Black | 21mm 53/64" | 5mm 13/64" | 4mm 5/32" |

RS504 Packing 25pcs/pack

Heidelberg

| COLOR | OUTSIDE | INSIDE | HEIGHT |
|-------|--------------------|----------------|----------------|
| Black | 30.5mm 1 13/64" | 5.5mm 7/32" | 12mm 15/32" |

RS509 Packing 12pcs/pack

Heidelberg
Excellent for thin paper

| COLOR | OUTSIDE | INSIDE | HEIGHT |
|-------|-----------------|--------------|--------------|
| Black | 27mm 1 1/16" | 7mm 9/32" | 7mm 9/32" |

SM52-G2.028.405

RS520 **RS521**

RS522 **RS523**

RS524

Heidelberg
Stitchmaster - refer to page 116

Check Page 126
for flat suckers

World-wide distribution of rubber suckers for the printing and packaging industry

The Master rubber sucker range has been developed over decades and is now distributed world-wide. Produced to original manufacturers' specifications our rubber suckers cope easily with the demands of to-days high speed printing presses.

Shaped Suckers – Alphabetically listed

On the following pages you will find, alphabetically listed, shaped suckers for nearly every press in the printing industry. We are continuously adding suckers for new or less known machine models so if you cannot find the rubber sucker you need please enquire. There may be times when the color of the sucker supplied does not match the picture in the leaflet, however the quality and material used will always remain unchanged.

Flat Suckers – Quick and easy identification system

All flat suckers are color coded according to thickness and the product code incorporates all dimensions as well as the color of the sucker enabling quick and easy identification:

Example:

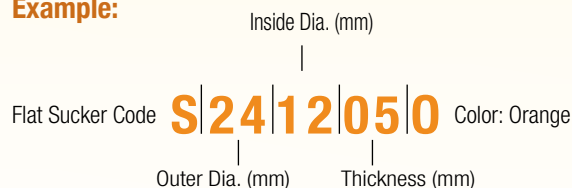

Color code:

Our rubber suckers are colored according to thickness

| | | | | |
|--------|---|-----|---------|------------|
| Orange | O | N/R | 0.5mm | 1/64" |
| Grey | G | N/R | 0.8mm | 1/32" |
| Blue | B | N/R | 1.0mm | 3/64" |
| Yellow | Y | N/R | 1.5mm | 1/16" |
| Green | N | N/R | 2.0mm | 5/64" |
| Red | R | SIL | 1.0mm | 3/64" |
| Red | R | SIL | 1.5mm | 1/16" |
| Clear | C | PER | various | Heidelberg |

Material:

N/R = Natural Rubber
PER = Synthetic Material
SIL = Silicon

HEIDELBERG

Quick reference guide

All flat rubber suckers for Heidelberg press models are kept in their original colors and have special product codes for easy identification:



HEIDELBERG Flat Rubber Suckers

| CODE | MATERIAL | COLOR | OUTSIDE | | INSIDE | | THICKNESS | | PACKING |
|---------------------------|-----------------|--------|---------|---------|--------|--------|-----------|-------|-------------|
| S381310R | SILICON | Red | 38mm | 1 1/2" | 13mm | 1/2" | 1mm | 3/64" | 25 pcs/pack |
| S381308R | SILICON | Red | 38mm | 1 1/2" | 13mm | 1/2" | 0.8mm | 1/32" | 25 pcs/pack |
| S381305R | SILICON | Red | 38mm | 1 1/2" | 13mm | 1/2" | 0.5mm | 1/64" | 25 pcs/pack |
| S321310R | SILICON | Red | 32mm | 1 1/4" | 13mm | 1/2" | 1mm | 3/64" | 25 pcs/pack |
| S321308R 66.028.406/C | SILICON | Red | 32mm | 1 1/4" | 13mm | 1/2" | 0.8mm | 1/32" | 25 pcs/pack |
| S321305R | SILICON | Red | 32mm | 1 1/4" | 13mm | 1/2" | 0.5mm | 1/64" | 25 pcs/pack |
| S381310C 66.028.404/B | "PER" Synthetic | Clear | 38mm | 1 1/2" | 13mm | 1/2" | 1mm | 3/64" | 25 pcs/pack |
| S321305C | "PER" Synthetic | Clear | 32mm | 1 1/4" | 13mm | 1/2" | 0.5mm | 1/64" | 25 pcs/pack |
| S301315C | "PER" Synthetic | Clear | 30mm | 1 3/16" | 13mm | 1/2" | 1.5mm | 1/16" | 25 pcs/pack |
| S301308C | "PER" Synthetic | Clear | 30mm | 1 3/16" | 13mm | 1/2" | 0.8mm | 1/32" | 25 pcs/pack |
| S241008Y 89.028.401/01 | "PER" Synthetic | Yellow | 24mm | 15/16" | 10mm | 25/64" | 0.8mm | 1/32" | 25 pcs/pack |
| S381310G 66.028.402 | Natural Rubber | Grey | 38mm | 1 1/2" | 13mm | 1/2" | 1mm | 3/64" | 25 pcs/pack |
| S301308G 66.028.401 | Natural Rubber | Grey | 30mm | 1 3/16" | 13mm | 1/2" | 0.8mm | 1/32" | 25 pcs/pack |
| S260620R | Natural Rubber | Red | 26mm | 1 1/32" | 6mm | 15/64" | 2mm | 5/64" | 25 pcs/pack |
| S220516R | Natural Rubber | Red | 22mm | 7/8" | 5mm | 13/64" | 1.6mm | 1/16" | 25 pcs/pack |
| S220320W | Natural Rubber | White | 22mm | 7/8" | 3mm | 1/8" | 2mm | 5/64" | 25 pcs/pack |

Heidelberg

| COLOR | OUTSIDE | INSIDE | HEIGHT |
|---------|--------------|--------------|--------------|
| Natural | 19mm 3/4" | 7mm 9/32" | 7mm 9/32" |

04.016.071

RS011 Packing 25pcs/pack

AB-Dick

| COLOR | OUTSIDE | INSIDE | HEIGHT |
|-------|--------------|--------------|------------------|
| Beige | 25.4mm 1" | 10mm 3/8" | 24.5mm 31/32" |

RS045 Packing 12pcs/pack

ATF Chief

| COLOR | OUTSIDE | INSIDE | HEIGHT |
|-------|-----------------|--------------|---------------|
| Grey | 27mm 1 1/16" | 7mm 9/32" | 6mm 15/64" |

RS501 Packing 25pcs/pack

ATF Chief

| COLOR | OUTSIDE | INSIDE | HEIGHT |
|-------|--------------|---------------|----------------|
| Blue | 16mm 5/8" | 9mm 23/64" | 21mm 53/64" |

RS012 Packing 12pcs/pack

AB-Dick

| COLOR | OUTSIDE | INSIDE | HEIGHT |
|-------|--------------|--------------|----------------|
| Beige | 25.5mm 1" | 10mm 3/8" | 25mm 63/64" |

RS046 Packing 12pcs/pack

ATF Chief

| COLOR | OUTSIDE | INSIDE | HEIGHT |
|-------|-----------------|----------------|---------------|
| Black | 28mm 1 7/64" | 17mm 43/64" | 6mm 15/64" |

RS508 Packing 12pcs/pack

ATF Chief

| COLOR | OUTSIDE | INSIDE | HEIGHT |
|-------|--------------|--------------|----------------|
| Black | 16mm 5/8" | 8mm 5/16" | 20mm 25/32" |

RS021 Packing 12pcs/pack

Albert

| COLOR | OUTSIDE | INSIDE | HEIGHT |
|-------|--------------|--------------|----------------|
| Brown | 25.4mm 1" | 7mm 9/32" | 7.5mm 5/16" |

RS048 Packing 12pcs/pack

ATF Chief

| COLOR | OUTSIDE | INSIDE | HEIGHT |
|-------|-----------------|--------------|----------------|
| Beige | 31mm 1 7/32" | 10mm 3/8" | 25mm 63/64" |

RS053 Packing 12pcs/pack

Aurelia-Omsca-Redaelli

| COLOR | OUTSIDE | INSIDE | HEIGHT |
|-------|-----------------|--------------|---------------|
| Beige | 26mm 1 1/32" | 7mm 9/32" | 9mm 23/64" |

RS043 Packing 12pcs/pack

ATF Chief

| COLOR | OUTSIDE | INSIDE | HEIGHT |
|-------|------------------|----------------|--------------|
| Beige | 36mm 1 27/64" | 17mm 43/64" | 8mm 5/16" |

RS049 Packing 12pcs/pack

ATF Chief

| COLOR | OUTSIDE | INSIDE | HEIGHT |
|-------|------------------|---------------|----------------|
| Blue | 34mm 1 11/32" | 6.5mm 1/4" | 20mm 25/32" |

RS055 Packing 12pcs/pack

Aurelia-Omsca-Redaelli

| COLOR | OUTSIDE | INSIDE | HEIGHT |
|---------|-----------------|---------------|----------------|
| Natural | 26mm 1 1/32" | 5mm 13/64" | 20mm 25/32" |

RS044 Packing 12pcs/pack

ATF Chief

| COLOR | OUTSIDE | INSIDE | HEIGHT |
|-------|-----------------|----------------|---------------|
| Beige | 30mm 1 3/16" | 14mm 35/64" | 6mm 15/64" |

RS050 Packing 12pcs/pack

ATF Chief

| COLOR | OUTSIDE | INSIDE | HEIGHT |
|-------|-----------------|----------------|---------------|
| Black | 28mm 1 7/64" | 17mm 43/64" | 6mm 15/64" |

RS508 Packing 12pcs/pack

Aurelia-Omsca-Redaelli

| COLOR | OUTSIDE | INSIDE | HEIGHT |
|-------|------------------|----------------|---------------|
| Clear | 46mm 1 13/16" | 17mm 43/64" | 9.5mm 3/8" |

RS061 Packing 12pcs/pack

Bobst

| COLOR | OUTSIDE | INSIDE | HEIGHT |
|---------|--------------|--------------|--------------|
| Natural | 16mm 5/8" | 2mm 5/64" | 13mm 1/2" |

RS091 Packing 12pcs/pack

Bremer

| COLOR | OUTSIDE | INSIDE | HEIGHT |
|-------|-----------------|---------------|--------------|
| Beige | 27mm 1 1/16" | 6.5mm 1/4" | 10mm 3/8" |

RS112 Packing 12pcs/pack

Chief

| COLOR | OUTSIDE | INSIDE | HEIGHT |
|-------|------------------|--------------|----------------|
| Clear | 41mm 1 39/64" | 16mm 5/8" | 14mm 35/64" |

RS062 Packing 12pcs/pack

Bobst

| COLOR | OUTSIDE | INSIDE | HEIGHT |
|---------|----------------|---------------|----------------|
| Natural | 12mm 15/32" | 5mm 13/64" | 14mm 35/64" |

RS092 Packing 12pcs/pack

Bremer

| COLOR | OUTSIDE | INSIDE | HEIGHT |
|---------|----------------|---------------|--------------|
| Natural | 24mm 15/16" | 5mm 13/64" | 13mm 1/2" |

RS116 Packing 12pcs/pack

Colormetal

| COLOR | OUTSIDE | INSIDE | HEIGHT |
|-------|----------------|---------------|---------------|
| Clear | 18mm 23/32" | 6mm 15/64" | 11mm 7/16" |

RS4071 Packing 12pcs/pack

Bonelli

| COLOR | OUTSIDE | INSIDE | HEIGHT |
|-------|-----------------|--------------|---------------|
| Beige | 26mm 1 1/32" | 7mm 9/32" | 9mm 23/64" |

RS043 Packing 12pcs/pack

C&P

| COLOR | OUTSIDE | INSIDE | HEIGHT |
|---------|------------------|--------------|------------------|
| Natural | 46mm 1 13/16" | 16mm 5/8" | 50mm 1 31/32" |

RS121 Packing 12pcs/pack

Crabtree

| COLOR | OUTSIDE | INSIDE | HEIGHT |
|-------|-----------------|---------------|----------------|
| Blue | 26mm 1 1/32" | 6mm 15/64" | 17mm 43/64" |

RS081 Packing 12pcs/pack

Bourj Modulen

| COLOR | OUTSIDE | INSIDE | HEIGHT |
|-------|--------------|--------------|----------------|
| Brown | 25.4mm 1" | 7mm 9/32" | 7.5mm 5/16" |

RS048 Packing 12pcs/pack

C&P

| COLOR | OUTSIDE | INSIDE | HEIGHT |
|-------|------------------|--------------|-----------------|
| Blue | 63mm 2 31/64" | 16mm 5/8" | 53mm 2 3/32" |

RS122 Packing 12pcs/pack

Crabtree

| COLOR | OUTSIDE | INSIDE | HEIGHT |
|---------|-----------------|---------------|----------------|
| Natural | 26mm 1 1/32" | 5mm 13/64" | 20mm 25/32" |

RS044 Packing 12pcs/pack

Bremer

| COLOR | OUTSIDE | INSIDE | HEIGHT |
|-------|-----------------|---------------|------------------|
| Beige | 26mm 1 1/32" | 6.5mm 1/4" | 10.5mm 13/32" |

RS111 Packing 12pcs/pack

Chief

| COLOR | OUTSIDE | INSIDE | HEIGHT |
|-------|-----------------|---------------|------------------|
| Beige | 26mm 1 1/32" | 6.5mm 1/4" | 10.5mm 13/32" |

RS111 Packing 12pcs/pack

Didde Glaser

| COLOR | OUTSIDE | INSIDE | HEIGHT |
|-------|-----------------|---------------|--------------|
| Beige | 27mm 1 1/16" | 6.5mm 1/4" | 10mm 3/8" |

RS112 Packing 12pcs/pack

Diddie Glaser

| COLOR | OUTSIDE | INSIDE | HEIGHT |
|-------|-----------------|--------------|---------------|
| Beige | 26mm 1 1/32" | 7mm 9/32" | 9mm 23/64" |

RS043 Packing 12pcs/pack

Gestetner

| COLOR | OUTSIDE | INSIDE | HEIGHT |
|---------|----------------|---------------|---------------|
| Natural | 18mm 23/32" | 6mm 15/64" | 6mm 15/64" |

RS172 Packing 12pcs/pack

Hamada

| COLOR | OUTSIDE | INSIDE | HEIGHT |
|-------|-----------------|--------------|-----------------|
| Grey | 26mm 1 1/32" | 10mm 3/8" | 26mm 1 1/32" |

RS131 Packing 12pcs/pack

Diddie Glaser

| COLOR | OUTSIDE | INSIDE | HEIGHT |
|-------|---------|--------|--------|
| RS043 | 26mm | 7mm | 9mm |
| Beige | 1 1/32" | 9/32" | 23/64" |
| RS111 | 26mm | 6.5mm | 10.5mm |
| Beige | 1 1/32" | 1/4" | 13/32" |
| RS112 | 27mm | 6.5mm | 10.5mm |
| Beige | 1 1/16" | 1/4" | 13/32" |

These 3 suckers for Giant are listed in the "Harris" section

Giant

| COLOR | OUTSIDE | INSIDE | HEIGHT |
|-------|--------------|---------------|---------------|
| Grey | 16mm 5/8" | 6mm 15/64" | 9.5mm 3/8" |

RS173 Packing 12pcs/pack

Hamada

| COLOR | OUTSIDE | INSIDE | HEIGHT |
|-------|----------------|---------------|--------------|
| Clear | 20mm 25/32" | 6mm 15/64" | 10mm 3/8" |

RS151 Packing 12pcs/pack

Duplo

| COLOR | OUTSIDE | INSIDE | HEIGHT |
|-------|--------------|--------------|----------------|
| Beige | 25.5mm 1" | 10mm 3/8" | 25mm 63/64" |

RS046 Packing 12pcs/pack

Giant

| COLOR | OUTSIDE | INSIDE | HEIGHT |
|---------|----------------|--------------|----------------|
| Natural | 18mm 23/32" | 4mm 5/32" | 17mm 43/64" |

RS174 Packing 12pcs/pack

Hamada

| COLOR | OUTSIDE | INSIDE | HEIGHT |
|-------|----------------|----------------|--------------|
| White | 20mm 25/32" | 3.5mm 9/64" | 10mm 3/8" |

RS152 Packing 12pcs/pack

Duplo

| COLOR | OUTSIDE | INSIDE | HEIGHT |
|-------|--------------|--------------|----------------|
| Brown | 25.4mm 1" | 7mm 9/32" | 7.5mm 5/16" |

RS048 Packing 12pcs/pack

Giant

| COLOR | OUTSIDE | INSIDE | HEIGHT |
|-------|------------------|----------------|------------------|
| Black | 16.5mm 21/32" | 12mm 15/32" | 36mm 1 27/64" |

RS175 Packing 12pcs/pack

Hamada

| COLOR | OUTSIDE | INSIDE | HEIGHT |
|-------|----------------|----------------|---------------|
| Clear | 25mm 63/64" | 15mm 19/32" | 6mm 15/64" |

RS161 Packing 12pcs/pack

Fuji-Shinohara

| COLOR | OUTSIDE | INSIDE | HEIGHT |
|-------|----------------|---------------|---------------|
| Beige | 20mm 25/32" | 9mm 23/64" | 6mm 15/64" |
| | | | 0020.1901 |

RS171 Packing 12pcs/pack

Hamada

| COLOR | OUTSIDE | INSIDE | HEIGHT |
|-------|-----------------|--------------|---------------|
| Beige | 26mm 1 1/32" | 7mm 9/32" | 9mm 23/64" |

RS043 Packing 12pcs/pack

Harris

| COLOR | OUTSIDE | INSIDE | HEIGHT |
|---------|-----------------|---------------|----------------|
| Natural | 26mm 1 1/32" | 5mm 13/64" | 20mm 25/32" |



RS044 Packing 12pcs/pack

Harris

| COLOR | OUTSIDE | INSIDE | HEIGHT |
|-------|----------------|--------------|----------------|
| Beige | 32mm 1 1/4" | 16mm 5/8" | 25mm 63/64" |



RS182 Packing 12pcs/pack

Harris

| COLOR | OUTSIDE | INSIDE | HEIGHT |
|-------|-----------------|---------------|----------------|
| White | 27mm 1 1/16" | 6mm 15/64" | 20mm 25/32" |



RS188 Packing 12pcs/pack

Harris

| COLOR | OUTSIDE | INSIDE | HEIGHT |
|-------|------------------|---------------|----------------|
| Blue | 34mm 1 11/32" | 6.5mm 1/4" | 20mm 25/32" |



RS055 Packing 12pcs/pack

Harris

| COLOR | OUTSIDE | INSIDE | HEIGHT |
|-------|----------------|---------------|--------------|
| Beige | 35mm 1 3/8" | 6mm 15/64" | 19mm 3/4" |



RS183 Packing 12pcs/pack

Harris

| COLOR | OUTSIDE | INSIDE | HEIGHT |
|-------|-----------------|--------------|-----------------------------|
| Grey | 27mm 1 1/16" | 7mm 9/32" | 6mm 15/64" 04.016.071 |



RS501 Packing 25pcs/pack

Heidelberg

| COLOR | OUTSIDE | INSIDE | HEIGHT |
|-------|-----------------|---------------|------------------|
| Beige | 26mm 1 1/32" | 6.5mm 1/4" | 10.5mm 13/32" |



RS111 Packing 12pcs/pack

Harris

| COLOR | OUTSIDE | INSIDE | HEIGHT |
|-------|--------------|--------------|------------------|
| Brown | 22mm 7/8" | 2mm 5/64" | 14.5mm 37/64" |



RS185 Packing 12pcs/pack

Harris

| COLOR | OUTSIDE | INSIDE | HEIGHT |
|-------|--------------|---------------|---------------|
| Beige | 22mm 7/8" | 6mm 15/64" | 5mm 13/64" |



RS502 Packing 25pcs/pack

Heidelberg

| COLOR | OUTSIDE | INSIDE | HEIGHT |
|-------|-----------------|---------------|--------------|
| Beige | 27mm 1 1/16" | 6.5mm 1/4" | 10mm 3/8" |



RS112 Packing 12pcs/pack

Harris

| COLOR | OUTSIDE | INSIDE | HEIGHT |
|-------|-----------------|---------------|--------------|
| Beige | 26mm 1 1/32" | 6mm 15/64" | 10mm 3/8" |



RS186 Packing 12pcs/pack

Harris

| COLOR | OUTSIDE | INSIDE | HEIGHT |
|-------|--------------|--------------|---------------------------|
| Red | 19mm 3/4" | 7mm 9/32" | 3mm 1/8" 42.016.072 |



RS503 Packing 25pcs/pack

Heidelberg

| COLOR | OUTSIDE | INSIDE | HEIGHT |
|-------|----------------|---------------|----------------|
| Black | 17mm 43/64" | 6mm 15/64" | 21mm 53/64" |



RS181 Packing 12pcs/pack

Harris

| COLOR | OUTSIDE | INSIDE | HEIGHT |
|-------|------------------|----------------|-----------------|
| Brown | 39mm 1 35/64" | 5.5mm 7/32" | 27mm 1 1/16" |



RS187 Packing 12pcs/pack

Harris

| COLOR | OUTSIDE | INSIDE | HEIGHT |
|-------|----------------|---------------|--------------|
| Black | 21mm 53/64" | 5mm 13/64" | 4mm 5/32" |



RS504 Packing 25pcs/pack

Heidelberg

| COLOR | OUTSIDE | INSIDE | HEIGHT |
|-------|------------------|--------------|--------------|
| Black | 16.5mm 21/32" | 7mm 9/32" | 7mm 9/32" |

42.016.073

RS505 Packing 12pcs/pack

Heidelberg

| COLOR | OUTSIDE | INSIDE | HEIGHT |
|-------|-----------------|--------------|---------------|
| Black | 29mm 1 9/64" | 7mm 9/32" | 9mm 23/64" |

Excellent for thin paper

RS299 Packing 12pcs/pack

Heidelberg

| COLOR | OUTSIDE | INSIDE | HEIGHT |
|-------|----------------|---------------|--------------|
| Black | 20mm 25/32" | 5mm 13/64" | 13mm 1/2" |

2144-240

RS520 Packing 12pcs/pack

Heidelberg Stitchmaster

| COLOR | OUTSIDE | INSIDE | HEIGHT |
|-------|------------------|--------------|------------------|
| Black | 15.5mm 39/64" | 4mm 5/32" | 16.5mm 21/32" |

A1.016.327/04

RS506 Packing 12pcs/pack

Heidelberg

| COLOR | OUTSIDE | INSIDE | HEIGHT |
|-------|-----------------|----------------|--------------|
| Grey | 27mm 1 1/16" | 17mm 43/64" | 7mm 9/32" |

SM52-G2.028.405

RS510 Packing 12pcs/pack

Heidelberg

| COLOR | OUTSIDE | INSIDE | HEIGHT |
|-------|--------------|-----------------|--------------|
| Black | 16mm 5/8" | 4.5mm 11/64" | 13mm 1/2" |

2144-241

RS521 Packing 12pcs/pack

Heidelberg Stitchmaster

| COLOR | OUTSIDE | INSIDE | HEIGHT |
|-------|------------------|---------------|-----------------|
| Black | 15.5mm 39/64" | 5mm 13/64" | 31mm 1 7/32" |

RS507 Packing 12pcs/pack

Heidelberg

| COLOR | OUTSIDE | INSIDE | HEIGHT |
|-------|----------------|----------------|----------------|
| Red | 23mm 29/32" | 12mm 15/32" | 3.5mm 9/64" |

CD74 F3.582.263/

RS511 Packing 12pcs/pack

Heidelberg

| COLOR | OUTSIDE | INSIDE | HEIGHT |
|-------|--------------|---------------|--------------|
| Black | 16mm 5/8" | 5mm 13/64" | 13mm 1/2" |

2144-242

RS522 Packing 12pcs/pack

Heidelberg Stitchmaster

| COLOR | OUTSIDE | INSIDE | HEIGHT |
|-------|-----------------|----------------|---------------|
| Black | 28mm 1 7/64" | 17mm 43/64" | 6mm 15/64" |

66.028.405

RS508 Packing 12pcs/pack

Heidelberg

| COLOR | OUTSIDE | INSIDE | HEIGHT |
|-------|-----------------|--------------|----------------|
| Clear | 31mm 1 7/32" | 16mm 5/8" | 14mm 35/64" |

00.580.6723/02

RS512 Packing 12pcs/pack

Heidelberg

| COLOR | OUTSIDE | INSIDE | HEIGHT |
|-------|----------------|---------------|--------------|
| Black | 20mm 25/32" | 5mm 13/64" | 13mm 1/2" |

2144-243

RS523 Packing 12pcs/pack

Heidelberg Stitchmaster

| COLOR | OUTSIDE | INSIDE | HEIGHT |
|-------|--------------------|----------------|----------------|
| Black | 30.5mm 1 13/64" | 5.5mm 7/32" | 12mm 15/32" |

Excellent for thin paper

RS509 Packing 12pcs/pack

Heidelberg

| COLOR | OUTSIDE | INSIDE | HEIGHT |
|-------|-----------------|--------------|----------------|
| Red | 28mm 1 7/64" | 16mm 5/8" | 3.6mm 9/64" |

XL105/XL106 F6.582.263

RS513 Packing 12pcs/pack

Heidelberg

| COLOR | OUTSIDE | INSIDE | HEIGHT |
|--------|--------------|-------------|----------------|
| Yellow | 13mm 1/2" | 3mm 1/8" | 15mm 19/32" |

RS524 Packing 12pcs/pack

Heidelberg Stitchmaster

| COLOR | OUTSIDE | INSIDE | HEIGHT |
|-------|----------------|--------------|--------------|
| Blue | 15mm 19/32" | 7mm 9/32" | 8mm 5/16" |



RS191 Packing 12pcs/pack

Horizon

| COLOR | OUTSIDE | INSIDE | HEIGHT |
|-------|------------------|----------------|------------------------------|
| Black | 44mm 1 46/64" | 5.5mm 7/32" | 15mm 19/32" oval shape |



RS202 Packing 12pcs/pack

Klockner

| COLOR | OUTSIDE | INSIDE | HEIGHT |
|-------|--------------|----------------|----------------|
| Red | 13mm 1/2" | 3.5mm 9/64" | 15mm 19/32" |



RS213 Packing 12pcs/pack

Kluge

| COLOR | OUTSIDE | INSIDE | HEIGHT |
|-------|--------------|---------------|----------------|
| Blue | 22mm 7/8" | 6mm 15/64" | 7.5mm 5/16" |



RS192 Packing 12pcs/pack

Horizon

| COLOR | OUTSIDE | INSIDE | HEIGHT |
|-------|-----------------|--------------|---------------|
| Beige | 26mm 1 1/32" | 7mm 9/32" | 9mm 23/64" |



RS043 Packing 12pcs/pack

Kluge

| COLOR | OUTSIDE | INSIDE | HEIGHT |
|-------|---------------|-----------------|----------------|
| Red | 9.3mm 3/8" | 4.5mm 11/64" | 15mm 19/32" |



RS214 Packing 12pcs/pack

Kluge

| COLOR | OUTSIDE | INSIDE | HEIGHT |
|-------|----------------|---------------|-----------------|
| Clear | 21mm 53/64" | 6mm 15/64" | 8.5mm 21/64" |



RS193 Packing 12pcs/pack

Horizon

| COLOR | OUTSIDE | INSIDE | HEIGHT |
|-------|--------------|-----------------|-----------------|
| Beige | 16mm 5/8" | 4.3mm 11/64" | 5.2mm 13/64" |



RS101 Packing 12pcs/pack

Kluge

| COLOR | OUTSIDE | INSIDE | HEIGHT |
|-------|---------------|-----------------|----------------|
| Blue | 9.3mm 3/8" | 4.5mm 11/64" | 15mm 19/32" |



RS215 Packing 12pcs/pack

Kluge

| COLOR | OUTSIDE | INSIDE | HEIGHT |
|-------|----------------|--------------|----------------|
| Black | 15mm 19/32" | 7mm 9/32" | 12mm 15/32" |



RS196 Packing 12pcs/pack

Itala

| COLOR | OUTSIDE | INSIDE | HEIGHT |
|-------|------------------|----------------|------------------|
| Red | 14.8mm 38/64" | 4.7mm 3/16" | 14.5mm 37/64" |



RS211 Packing 12pcs/pack

Kluge

| COLOR | OUTSIDE | INSIDE | HEIGHT |
|-------|--------------|---------------|---------------|
| Beige | 22mm 7/8" | 6mm 15/64" | 5mm 13/64" |



RS502 Packing 25pcs/pack

Kluge

| COLOR | OUTSIDE | INSIDE | HEIGHT |
|-------|------------------|----------------|------------------------------|
| Black | 36mm 1 27/64" | 5.5mm 7/32" | 15mm 19/32" oval shape |



RS201 Packing 12pcs/pack

Klockner

| COLOR | OUTSIDE | INSIDE | HEIGHT |
|-------|--------------|----------------|--------------|
| Red | 25.5mm 1" | 4.7mm 3/16" | 16mm 5/8" |



RS212 Packing 12pcs/pack

Kluge

| COLOR | OUTSIDE | INSIDE | HEIGHT |
|-------|--------------|--------------|----------------|
| Black | 16mm 5/8" | 8mm 5/16" | 20mm 25/32" |



RS021 Packing 12pcs/pack

Kolbus

| COLOR | OUTSIDE | INSIDE | HEIGHT |
|--------|----------------|---------------|----------------|
| Orange | 21mm 53/64" | 6mm 15/64" | 15mm 19/32" |



RS403 Packing 12pcs/pack

Kolbus

| COLOR | OUTSIDE | INSIDE | HEIGHT |
|-------|----------------|---------------|-----------------|
| Black | 18mm 23/32" | 5mm 13/64" | 29mm 1 9/64" |



RS233 Packing 12pcs/pack

Kolbus

| COLOR | OUTSIDE | INSIDE | HEIGHT |
|---------|-----------------|---------------|----------------|
| Natural | 26mm 1 1/32" | 5mm 13/64" | 20mm 25/32" |



RS044 Packing 12pcs/pack

Macey

| COLOR | OUTSIDE | INSIDE | HEIGHT |
|-------|----------------|---------------|----------------|
| Green | 25mm 63/64" | 6mm 15/64" | 14mm 35/64" |



RS405 Packing 12pcs/pack

Kolbus

| COLOR | OUTSIDE | INSIDE | HEIGHT |
|-------|-----------------|--------------|--------------|
| Black | 28mm 1 7/64" | 16mm 5/8" | 8mm 5/16" |

444-1682-004



RS291 Packing 12pcs/pack

Komori

| COLOR | OUTSIDE | INSIDE | HEIGHT |
|-------|-----------------|---------------|--------------|
| Beige | 26mm 1 1/32" | 6mm 15/64" | 10mm 3/8" |



RS186 Packing 12pcs/pack

Macey

| COLOR | OUTSIDE | INSIDE | HEIGHT |
|-------|----------------|---------------|--------------|
| Black | 18mm 23/32" | 5mm 13/64" | 22mm 7/8" |



RS230 Packing 12pcs/pack

Kolbus

| COLOR | OUTSIDE | INSIDE | HEIGHT |
|-------|-----------------|---------------|--------------|
| Black | 26mm 1 1/32" | 9mm 23/64" | 8mm 5/16" |

L28/L29/LSX29 294-1612-400



RS292 Packing 12pcs/pack

Komori

| COLOR | OUTSIDE | INSIDE | HEIGHT |
|-------|--------------|---------------|---------------|
| Beige | 25.3mm 1" | 6mm 15/64" | 9mm 23/64" |



RS241 Packing 12pcs/pack

Macey

| COLOR | OUTSIDE | INSIDE | HEIGHT |
|-------|----------------|---------------|--------------|
| Blue | 18mm 23/32" | 5mm 13/64" | 22mm 7/8" |



RS231 Packing 12pcs/pack

Kolbus

| COLOR | OUTSIDE | INSIDE | HEIGHT |
|-------|----------------|---------------|--------------|
| Black | 24mm 15/16" | 6mm 15/64" | 8mm 5/16" |



RS298 Packing 12pcs/pack

Komori

| COLOR | OUTSIDE | INSIDE | HEIGHT |
|---------|------------------|--------------|------------------|
| Natural | 46mm 1 13/16" | 16mm 5/8" | 50mm 1 31/32" |



RS121 Packing 12pcs/pack

Maitlander

| COLOR | OUTSIDE | INSIDE | HEIGHT |
|-------|---------------|-------------|--------------|
| Clear | 11mm 7/16" | 3mm 1/8" | 16mm 5/8" |



RS232 Packing 12pcs/pack

Kolbus

| COLOR | OUTSIDE | INSIDE | HEIGHT |
|-------|-----------------|--------------|---------------|
| Black | 29mm 1 9/64" | 7mm 9/32" | 9mm 23/64" |

Excellent for thin paper



L40
RS299 Packing 12pcs/pack

Komori

| COLOR | OUTSIDE | INSIDE | HEIGHT |
|-------|------------------|--------------|-----------------|
| Blue | 63mm 2 31/64" | 16mm 5/8" | 53mm 2 3/32" |



RS122 Packing 12pcs/pack

Maitlander

| COLOR | OUTSIDE | INSIDE | HEIGHT |
|-------|----------------|---------------|--------------|
| Beige | 24mm 15/16" | 6mm 15/64" | 13mm 1/2" |

Major

RS116 Packing 12pcs/pack

| COLOR | OUTSIDE | INSIDE | HEIGHT |
|-------|----------------|---------------|---------------|
| Clear | 18mm 23/32" | 6mm 15/64" | 11mm 7/16" |

Mc Cain

RS4071 Packing 12pcs/pack

| COLOR | OUTSIDE | INSIDE | HEIGHT |
|-------|-----------------|--------------|----------------|
| Beige | 31mm 1 7/32" | 10mm 3/8" | 25mm 63/64" |

Miehle

RS053 Packing 12pcs/pack

| COLOR | OUTSIDE | INSIDE | HEIGHT |
|-------|-----------------|---------------|------------------|
| Beige | 15.75mm 5/8" | 5mm 13/64" | 14.5mm 37/64" |

Major

RS246 Packing 12pcs/pack

| COLOR | OUTSIDE | INSIDE | HEIGHT |
|-------|-----------------|--------------|---------------|
| Beige | 26mm 1 1/32" | 7mm 9/32" | 9mm 23/64" |

Miehle

RS043 Packing 12pcs/pack

| COLOR | OUTSIDE | INSIDE | HEIGHT |
|---------|--------------|--------------|--------------|
| Natural | 16mm 5/8" | 2mm 5/64" | 13mm 1/2" |

Miehle - Dexter

RS091 Packing 12pcs/pack

| COLOR | OUTSIDE | INSIDE | HEIGHT |
|---------|-----------------|---------------|----------------|
| Natural | 26mm 1 1/32" | 5mm 13/64" | 20mm 25/32" |

M.A.N.

RS044 Packing 12pcs/pack

| COLOR | OUTSIDE | INSIDE | HEIGHT |
|---------|-----------------|---------------|----------------|
| Natural | 26mm 1 1/32" | 5mm 13/64" | 20mm 25/32" |

Miehle

RS044 Packing 12pcs/pack

| COLOR | OUTSIDE | INSIDE | HEIGHT |
|-------|------------------|--------------|-----------------|
| Blue | 63mm 2 31/64" | 16mm 5/8" | 53mm 2 3/32" |

Miehle

RS122 Packing 12pcs/pack

| COLOR | OUTSIDE | INSIDE | HEIGHT |
|---------|--------------|--------------|--------------|
| Natural | 16mm 5/8" | 2mm 5/64" | 13mm 1/2" |

Mc Cain

RS091 Packing 12pcs/pack

| COLOR | OUTSIDE | INSIDE | HEIGHT |
|-------|--------------|--------------|----------------|
| Beige | 25.5mm 1" | 10mm 3/8" | 25mm 63/64" |

Miehle

RS045 Packing 12pcs/pack

| COLOR | OUTSIDE | INSIDE | HEIGHT |
|-------|-----------------|--------------|-----------------|
| Grey | 26mm 1 1/32" | 10mm 3/8" | 26mm 1 1/32" |

Miehle

RS131 Packing 12pcs/pack

| COLOR | OUTSIDE | INSIDE | HEIGHT |
|-------|------------------|-------------|----------------|
| Black | 17.5mm 11/16" | 3mm 1/8" | 18mm 23/32" |

Mc Cain

RS261 Packing 12pcs/pack

| COLOR | OUTSIDE | INSIDE | HEIGHT |
|-------|--------------|--------------|------------------|
| Beige | 25.4mm 1" | 10mm 3/8" | 24.5mm 31/32" |

Miehle - Dexter

RS046 Packing 12pcs/pack

| COLOR | OUTSIDE | INSIDE | HEIGHT |
|---------|-----------------|--------------|----------------|
| Natural | 27mm 1 1/16" | 10mm 3/8" | 23mm 29/32" |

Miehle

RS271 Packing 12pcs/pack

| COLOR | OUTSIDE | INSIDE | HEIGHT |
|--------|----------------|--------------|-------------------------|
| Yellow | 35mm 1 3/8" | 10mm 3/8" | 27mm 1 1/16" Soft |



RS272 Packing 12pcs/pack

Miehle

| COLOR | OUTSIDE | INSIDE | HEIGHT |
|-------|-----------------|----------------|---------------|
| Black | 28mm 1 7/64" | 17mm 43/64" | 6mm 15/64" |



RS508 Packing 12pcs/pack

Miehle

| COLOR | OUTSIDE | INSIDE | HEIGHT |
|-------|-----------------|-----------------|--------------|
| Black | 27mm 1 1/16" | 7.5mm 19/64" | 8mm 5/16" |



RS301 Packing 12pcs/pack

Mitsubishi

| COLOR | OUTSIDE | INSIDE | HEIGHT |
|-------|----------------|--------------|-------------------------|
| Beige | 35mm 1 3/8" | 10mm 3/8" | 27mm 1 1/16" Hard |



RS273 Packing 12pcs/pack

Miehle

| COLOR | OUTSIDE | INSIDE | HEIGHT |
|-------|----------------|---------------|--------------|
| Beige | 24mm 15/16" | 6mm 15/64" | 13mm 1/2" |



RS116 Packing 12pcs/pack

Miller

| COLOR | OUTSIDE | INSIDE | HEIGHT |
|-------|------------------|--------------|----------------|
| Red | 43mm 1 11/16" | 8mm 5/16" | 15mm 19/32" |



RS302 Packing 12pcs/pack

Mitsubishi

| COLOR | OUTSIDE | INSIDE | HEIGHT |
|-------|------------------|--------------|------------------|
| Grey | 39mm 1 35/64" | 16mm 5/8" | 49mm 1 59/64" |



RS275 Packing 12pcs/pack

Miehle

| COLOR | OUTSIDE | INSIDE | HEIGHT |
|-------|-----------------|--------------|-----------------|
| Grey | 26mm 1 1/32" | 10mm 3/8" | 26mm 1 1/32" |



RS131 Packing 12pcs/pack

Miller

| COLOR | OUTSIDE | INSIDE | HEIGHT |
|-------|----------------|--------------|----------------|
| Black | 15mm 19/32" | 7mm 9/32" | 12mm 15/32" |



RS196 Packing 12pcs/pack

Muller

| COLOR | OUTSIDE | INSIDE | HEIGHT |
|-------|-----------------|--------------|--------------|
| Grey | 26mm 1 1/32" | 7mm 9/32" | 10mm 3/8" |



RS278 Packing 12pcs/pack

Miehle

| COLOR | OUTSIDE | INSIDE | HEIGHT |
|-------|-------------------|---------------|------------------|
| Beige | 15.75mm 39/64" | 5mm 13/64" | 14.5mm 37/64" |



RS246 Packing 12pcs/pack

Miller

| COLOR | OUTSIDE | INSIDE | HEIGHT |
|-------|----------------|---------------|-----------------|
| Black | 15mm 19/32" | 6.5mm 1/4" | 8.5mm 21/64" |



RS311 Packing 12pcs/pack

Muller

| COLOR | OUTSIDE | INSIDE | HEIGHT |
|-------|-----------------|--------------|---------------|
| Grey | 28mm 1 7/64" | 7mm 9/32" | 10mm 3/18" |



RS279 Packing 12pcs/pack

Miehle

| COLOR | OUTSIDE | INSIDE | HEIGHT |
|-------|-----------------|----------------|---------------|
| Black | 28mm 1 7/64" | 17mm 43/64" | 6mm 15/64" |



RS508 Packing 12pcs/pack

Miller

| COLOR | OUTSIDE | INSIDE | HEIGHT |
|--------|----------------|---------------|--------------|
| Orange | 12mm 15/32" | 6mm 15/64" | 8mm 5/16" |



RS401 Packing 12pcs/pack

Muller Martini

| COLOR | OUTSIDE | INSIDE | HEIGHT |
|-------|--------------|--------------|--------------|
| Black | 16mm 5/8" | 7mm 9/32" | 10mm 3/8" |



Shore hardness 55

RS402 Packing 12pcs/pack

Muller Martini

| COLOR | OUTSIDE | INSIDE | HEIGHT |
|-------|----------------|---------------|----------------|
| Black | 21mm 53/64" | 6mm 15/64" | 15mm 19/32" |



RS404 Packing 12pcs/pack

Muller Martini

| COLOR | OUTSIDE | INSIDE | HEIGHT |
|--------|----------------|---------------|---------------|
| Orange | 18mm 23/32" | 6mm 15/64" | 11mm 7/16" |



Shore hardness 50

RS4073 Packing 12pcs/pack

Muller Martini

| COLOR | OUTSIDE | INSIDE | HEIGHT |
|--------|--------------|--------------|--------------|
| Orange | 16mm 5/8" | 7mm 9/32" | 10mm 3/8" |



RS4021 Packing 12pcs/pack

Muller Martini

| COLOR | OUTSIDE | INSIDE | HEIGHT |
|-------|----------------|---------------|------------------|
| Green | 25mm 63/64" | 6mm 15/64" | 14.5mm 37/64" |



RS405 Packing 12pcs/pack

Muller Martini

| COLOR | OUTSIDE | INSIDE | HEIGHT |
|-------|----------------|---------------|---------------|
| Black | 18mm 23/32" | 6mm 15/64" | 11mm 7/16" |



Shore hardness 55

RS4074 Packing 12pcs/pack

Muller Martini

| COLOR | OUTSIDE | INSIDE | HEIGHT |
|--------|----------------|---------------|----------------|
| Orange | 21mm 53/64" | 6mm 15/64" | 15mm 19/32" |



RS403 Packing 12pcs/pack

Muller Martini

| COLOR | OUTSIDE | INSIDE | HEIGHT |
|-------|----------------|---------------|------------------|
| Black | 25mm 63/64" | 6mm 15/64" | 14.5mm 37/64" |



RS406 Packing 12pcs/pack

Muller Martini

| COLOR | OUTSIDE | INSIDE | HEIGHT |
|---------|----------------|---------------|--------------|
| Natural | 18mm 23/32" | 5mm 13/64" | 10mm 3/8" |



Shore hardness 40

RS4081 Packing 12pcs/pack

Muller Martini

| COLOR | OUTSIDE | INSIDE | HEIGHT |
|-------|----------------|---------------|----------------|
| Clear | 21mm 53/64" | 6mm 15/64" | 15mm 19/32" |
| | | | 20.1926 |



RS4031 Packing 12pcs/pack

Muller Martini

| COLOR | OUTSIDE | INSIDE | HEIGHT |
|-------|----------------|---------------|---------------|
| Clear | 18mm 23/32" | 6mm 15/64" | 11mm 7/16" |



Shore hardness 40

RS4071 Packing 12pcs/pack

Muller Martini

| COLOR | OUTSIDE | INSIDE | HEIGHT |
|--------|----------------|---------------|--------------|
| Orange | 18mm 23/32" | 5mm 13/64" | 10mm 3/8" |



Shore hardness 50

RS4082 Packing 12pcs/pack

Muller Martini

| COLOR | OUTSIDE | INSIDE | HEIGHT |
|-------|----------------|---------------|----------------|
| Red | 20mm 25/32" | 5mm 13/64" | 15mm 19/32" |

Extra durable



RS418 Packing 12pcs/pack

Muller Martini

| COLOR | OUTSIDE | INSIDE | HEIGHT |
|-------|----------------|---------------|---------------|
| Blue | 18mm 23/32" | 6mm 15/64" | 11mm 7/16" |



Shore hardness 45

RS4072 Packing 12pcs/pack

Muller Martini

| COLOR | OUTSIDE | INSIDE | HEIGHT |
|-------|----------------|---------------|--------------|
| Black | 18mm 23/32" | 5mm 13/64" | 10mm 3/8" |



Shore hardness 55

RS4083 Packing 12pcs/pack

Muller Martini

| COLOR | OUTSIDE | INSIDE | HEIGHT |
|---------|----------------|---------------|--------------|
| Natural | 17mm 43/64" | 5mm 13/64" | 10mm 3/8" |



Shore hardness 40

RS4091 Packing 12pcs/pack

Muller Martini

| COLOR | OUTSIDE | INSIDE | HEIGHT |
|-------|----------------|---------------|--------------|
| Red | 25mm 63/64" | 6mm 15/64" | 13mm 1/2" |



Packing 12pcs/pack

RS411

Muller Martini

| COLOR | OUTSIDE | INSIDE | HEIGHT |
|-------|--------------|--------------|----------------|
| Black | 16mm 5/8" | 8mm 5/16" | 20mm 25/32" |



Packing 12pcs/pack

RS021

Nebiolo

| COLOR | OUTSIDE | INSIDE | HEIGHT |
|-------|----------------|---------------|--------------|
| Blue | 17mm 43/64" | 5mm 13/64" | 10mm 3/8" |



Shore hardness 45

RS4092 Packing 12pcs/pack

Muller Martini

| COLOR | OUTSIDE | INSIDE | HEIGHT |
|-------|----------------|---------------|--------------|
| Red | 14mm 35/64" | 6mm 15/64" | 13mm 1/2" |



Packing 12pcs/pack

RS412

Muller Martini

| COLOR | OUTSIDE | INSIDE | HEIGHT |
|-------|--------------|--------------|-------------|
| Red | 19mm 3/4" | 7mm 9/32" | 3mm 1/8" |



Packing 25pcs/pack

RS503

Nebiolo

| COLOR | OUTSIDE | INSIDE | HEIGHT |
|--------|----------------|---------------|--------------|
| Orange | 17mm 43/64" | 5mm 13/64" | 10mm 3/8" |



Shore hardness 50

RS4093 Packing 12pcs/pack

Muller Martini

| COLOR | OUTSIDE | INSIDE | HEIGHT |
|-------|----------------|-----------------|--------------|
| Red | 17mm 43/64" | 4.5mm 11/64" | 10mm 3/8" |



Packing 12pcs/pack

RS414

Muller Martini

| COLOR | OUTSIDE | INSIDE | HEIGHT |
|-------|------------------|--------------|--------------|
| Black | 16.5mm 21/32" | 7mm 9/32" | 7mm 9/32" |



Packing 12pcs/pack

RS505

Nebiolo

| COLOR | OUTSIDE | INSIDE | HEIGHT |
|-------|----------------|---------------|--------------|
| Black | 17mm 43/64" | 5mm 13/64" | 10mm 3/8" |



Shore hardness 55

RS4094 Packing 12pcs/pack

Muller Martini

| COLOR | OUTSIDE | INSIDE | HEIGHT |
|---------|--------------|--------------|--------------|
| Natural | 16mm 5/8" | 2mm 5/64" | 13mm 1/2" |



Packing 12pcs/pack

RS091

Multith

| COLOR | OUTSIDE | INSIDE | HEIGHT |
|-------|----------------|---------------|---------------|
| Black | 18mm 23/32" | 6mm 15/64" | 9.5mm 3/8" |



Packing 12pcs/pack

RS331

Neckar

| COLOR | OUTSIDE | INSIDE | HEIGHT |
|-------|----------------|---------------|------------------|
| Black | 25mm 63/64" | 6mm 15/64" | 10.5mm 13/32" |



Packing 12pcs/pack

RS410

Muller Martini

| COLOR | OUTSIDE | INSIDE | HEIGHT |
|---------|--------------|---------------|----------------|
| Natural | 22mm 7/8" | 6mm 15/64" | 23mm 29/32" |



Packing 12pcs/pack

RS321

Multith

| COLOR | OUTSIDE | INSIDE | HEIGHT |
|-------|----------------|--------------|----------------|
| Black | 15mm 19/32" | 2mm 5/64" | 12mm 15/32" |



Packing 12pcs/pack

RS341

Panduro

| COLOR | OUTSIDE | INSIDE | HEIGHT |
|-------|----------------|-------------|--------------|
| Blue | 18mm 23/32" | 3mm 1/8" | 13mm 1/2" |

RS342 Packing 12pcs/pack

Panduro

| COLOR | OUTSIDE | INSIDE | HEIGHT |
|-------|--------------|--------------|------------------|
| Beige | 25.4mm 1" | 10mm 3/8" | 24.5mm 31/32" |

RS045 Packing 12pcs/pack

Roland

| COLOR | OUTSIDE | INSIDE | HEIGHT |
|-------|------------------|--------------|------------------|
| Grey | 39mm 1 35/64" | 16mm 5/8" | 49mm 1 59/64" |

RS275 Packing 12pcs/pack

Roland

| COLOR | OUTSIDE | INSIDE | HEIGHT |
|---------|--------------|--------------|--------------|
| Natural | 16mm 5/8" | 2mm 5/64" | 13mm 1/2" |

RS091 Packing 12pcs/pack

Phillipsburg

| COLOR | OUTSIDE | INSIDE | HEIGHT |
|-------|-----------------|--------------|----------------|
| Beige | 27mm 1 1/16" | 10mm 3/8" | 25mm 63/64" |

RS046 Packing 12pcs/pack

Roland

| COLOR | OUTSIDE | INSIDE | HEIGHT |
|-------|-----------------|----------------|---------------|
| Black | 28mm 1 7/64" | 17mm 43/64" | 6mm 15/64" |

RS508 Packing 12pcs/pack

Roland

| COLOR | OUTSIDE | INSIDE | HEIGHT |
|-------|----------------|-------------|--------------|
| Blue | 18mm 23/32" | 3mm 1/8" | 13mm 1/2" |

RS342 Packing 12pcs/pack

Phillipsburg

| COLOR | OUTSIDE | INSIDE | HEIGHT |
|-------|-----------------|--------------|----------------|
| Beige | 31mm 1 7/32" | 10mm 3/8" | 25mm 63/64" |

RS053 Packing 12pcs/pack

Roland

| COLOR | OUTSIDE | INSIDE | HEIGHT |
|----------|--------------------|------------------|------------------|
| Natural | 30.5mm 1 13/64" | 15.5mm 39/64" | 15.5mm 39/64" |
| Standard | | | 021F013230 |

RS601 Packing 12pcs/pack

Roland

| COLOR | OUTSIDE | INSIDE | HEIGHT |
|-------|--------------|-----------------|-----------------|
| Beige | 16mm 5/8" | 4.3mm 11/64" | 5.2mm 13/64" |

RS101 Packing 12pcs/pack

Rice

| COLOR | OUTSIDE | INSIDE | HEIGHT |
|--------|----------------|--------------|-----------------|
| Yellow | 35mm 1 3/8" | 10mm 3/8" | 27mm 1 1/16" |

Soft

RS272 Packing 12pcs/pack

Roland

| COLOR | OUTSIDE | INSIDE | HEIGHT |
|-------|--------------------|------------------|------------------|
| Blue | 30.5mm 1 13/64" | 15.5mm 39/64" | 15.5mm 39/64" |
| Hard | | | 021F013230 |

RS602 Packing 12pcs/pack

Roland

| COLOR | OUTSIDE | INSIDE | HEIGHT |
|-------|-----------------|--------------|---------------|
| Beige | 26mm 1 1/32" | 7mm 9/32" | 9mm 23/64" |

RS043 Packing 12pcs/pack

Roland

| COLOR | OUTSIDE | INSIDE | HEIGHT |
|-------|----------------|--------------|-----------------|
| Beige | 35mm 1 3/8" | 10mm 3/8" | 27mm 1 1/16" |

Hard

RS273 Packing 12pcs/pack

Roland

| COLOR | OUTSIDE | INSIDE | HEIGHT |
|---------|----------------|-----------------|--------------|
| Natural | 21mm 53/64" | 5.8mm 15/64" | 19mm 3/4" |

RS351 Packing 12pcs/pack

Rotaprint

| COLOR | OUTSIDE | INSIDE | HEIGHT |
|-------|----------------|-----------------|--------------|
| Black | 14mm 35/64" | 5.8mm 15/64" | 19mm 3/4" |



RS352 Packing 12pcs/pack

Rotaprint

| COLOR | OUTSIDE | INSIDE | HEIGHT |
|-------|------------------|---------------|------------------|
| Clear | 22.5mm 57/64" | 6.2mm 1/4" | 20.5mm 51/64" |



RS365 Packing 12pcs/pack

Ryobi

| COLOR | OUTSIDE | INSIDE | HEIGHT |
|-------|----------------|---------------|----------------|
| Black | 17mm 43/64" | 6mm 15/64" | 21mm 53/64" |



RS181 Packing 12pcs/pack

Sheridan

| COLOR | OUTSIDE | INSIDE | HEIGHT |
|-------|--------------|--------------|-----------------|
| Beige | 16mm 5/8" | 4mm 5/32" | 4.5mm 11/64" |



RS361 Packing 25pcs/pack

Ryobi

| COLOR | OUTSIDE | INSIDE | HEIGHT |
|-------|--------------|---------------|----------------|
| Clear | 19mm 3/4" | 6.5mm 1/4" | 20mm 25/32" |



RS366 Packing 12pcs/pack

Ryobi

| COLOR | OUTSIDE | INSIDE | HEIGHT |
|---------|------------------|-------------|----------------|
| Natural | 17.5mm 11/16" | 3mm 1/8" | 18mm 23/32" |



RS381 Packing 12pcs/pack

Sheridan

| COLOR | OUTSIDE | INSIDE | HEIGHT |
|-------|----------------|-------------|--------------|
| Blue | 18mm 23/32" | 3mm 1/8" | 4mm 5/32" |



RS362 Packing 25pcs/pack

Ryobi

| COLOR | OUTSIDE | INSIDE | HEIGHT |
|-------|-----------------|--------------|---------------|
| Red | 28mm 1 7/64" | 16mm 5/8" | 9mm 23/64" |



Now extra durable

RS371 Packing 12pcs/pack

Sakurai

| COLOR | OUTSIDE | INSIDE | HEIGHT |
|--------|----------------|--------------|-----------------|
| Yellow | 35mm 1 3/8" | 10mm 3/8" | 27mm 1 1/16" |



Soft

RS272 Packing 12pcs/pack

Sigma

| COLOR | OUTSIDE | INSIDE | HEIGHT |
|---------|--------------|---------------|--------------|
| Natural | 22mm 7/8" | 6mm 15/64" | 22mm 7/8" |



RS363 Packing 12pcs/pack

Ryobi

| COLOR | OUTSIDE | INSIDE | HEIGHT |
|---------|-----------------|---------------|----------------|
| Natural | 26mm 1 1/32" | 5mm 13/64" | 20mm 25/32" |



RS044 Packing 12pcs/pack

Sheridan

| COLOR | OUTSIDE | INSIDE | HEIGHT |
|-------|----------------|--------------|-----------------|
| Beige | 35mm 1 3/8" | 10mm 3/8" | 27mm 1 1/16" |



Hard

RS273 Packing 12pcs/pack

Sigma

| COLOR | OUTSIDE | INSIDE | HEIGHT |
|-------|--------------|---------------|----------------|
| Red | 19mm 3/4" | 6.5mm 1/4" | 24mm 15/16" |



RS364 Packing 12pcs/pack

Ryobi

| COLOR | OUTSIDE | INSIDE | HEIGHT |
|---------|--------------|--------------|--------------|
| Natural | 16mm 5/8" | 2mm 5/64" | 13mm 1/2" |



RS091 Packing 12pcs/pack

Sheridan

| COLOR | OUTSIDE | INSIDE | HEIGHT |
|-------|-----------------|--------------|---------------|
| Beige | 26mm 1 1/32" | 7mm 9/32" | 9mm 23/64" |



RS043 Packing 12pcs/pack

Stahl

| COLOR | OUTSIDE | INSIDE | HEIGHT |
|-------|-----------------|---------------|------------------|
| Beige | 26mm 1 1/32" | 6.5mm 1/4" | 10.5mm 13/32" |



RS111 Packing 12pcs/pack

Stahl

| COLOR | OUTSIDE | INSIDE | HEIGHT |
|-------|-----------------|--------------|----------------|
| Black | 27mm 1 1/16" | 10mm 3/8" | 1.5mm 1/16" |



RS393 Packing 12pcs/pack

Thompson

| COLOR | OUTSIDE | INSIDE | HEIGHT |
|---------|-----------------|---------------|----------------|
| Natural | 26mm 1 1/32" | 5mm 13/64" | 20mm 25/32" |



RS044 Packing 12pcs/pack

Wohlemberg

| COLOR | OUTSIDE | INSIDE | HEIGHT |
|--------|----------------|---------------|--------------|
| Orange | 12mm 15/32" | 6mm 15/64" | 8mm 5/16" |



RS401 Packing 12pcs/pack

Stahl

| COLOR | OUTSIDE | INSIDE | HEIGHT |
|-------|-----------------|-------------|----------------|
| Black | 27mm 1 1/16" | 3mm 1/8" | 1.5mm 1/16" |



RS394 Packing 12pcs/pack

Thompson

| COLOR | OUTSIDE | INSIDE | HEIGHT |
|-------|----------------|---------------|----------------|
| Black | 17mm 43/64" | 6mm 15/64" | 21mm 53/64" |



RS181 Packing 12pcs/pack

Wohlemberg

| COLOR | OUTSIDE | INSIDE | HEIGHT |
|-------|--------------|---------------|---------------|
| Black | 16mm 5/8" | 6mm 15/64" | 11mm 7/16" |



RS386 Packing 12pcs/pack

Stahl

| COLOR | OUTSIDE | INSIDE | HEIGHT |
|---------|--------------|---------------|----------------|
| Natural | 22mm 7/8" | 6mm 15/64" | 23mm 29/32" |



RS321 Packing 12pcs/pack

Toko

| COLOR | OUTSIDE | INSIDE | HEIGHT |
|-------|----------------|---------------|--------------|
| Black | 18mm 23/32" | 5mm 13/64" | 19mm 3/4" |



RS631 Packing 12pcs/pack

Stahl

| COLOR | OUTSIDE | INSIDE | HEIGHT |
|-------|-----------------|---------------|------------------|
| RS043 | 26mm 1 1/32" | 7mm 9/32" | 9mm 23/64" |
| Beige | 25.4mm 1" | 7mm 9/32" | 7.5mm 19/64" |
| RS111 | 26mm 1 1/32" | 6.5mm 1/4" | 10.5mm 13/32" |
| RS112 | 27mm 1 1/16" | 6.5mm 1/4" | 10.5mm 13/32" |

These 4 suckers for "WEB" are listed in the "Harris" section

Web - Refer to Harris

| COLOR | OUTSIDE | INSIDE | HEIGHT |
|-------|----------------|--------------|---------------|
| Black | 20mm 25/32" | 2mm 5/64" | 6.5mm 1/4" |



RS391 Packing 12pcs/pack

Thisen & Bontitz

| COLOR | OUTSIDE | INSIDE | HEIGHT |
|---------|----------------|---------------|----------------|
| Natural | 20mm 25/32" | 5mm 13/64" | 23mm 29/32" |



RS396 Packing 12pcs/pack

Winkler

BOBST FLAT SUCKERS - IN DURABLE SILICON

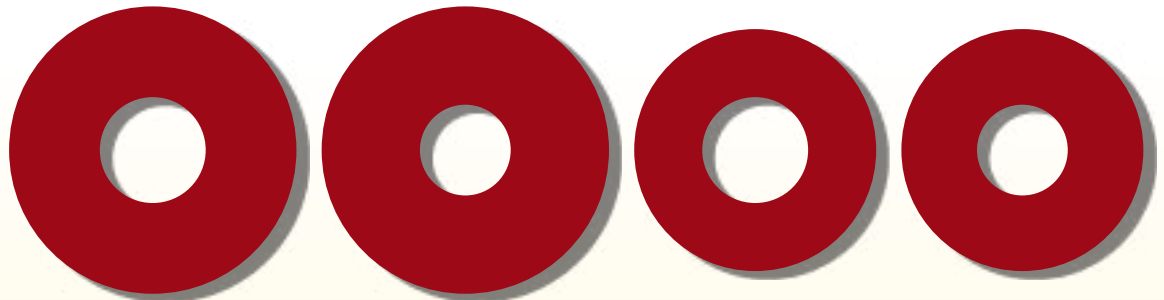

QUICK REFERENCE GUIDE

S381410R

S381210R

S321410R

S321210R

| Bobst | | | -----MM----- | | | -----INCHES----- | | | PACKING |
|----------|----------|-------|--------------|--------|-----------|------------------|--------|-----------|-------------|
| CODE | MATERIAL | COLOR | OUTSIDE | INSIDE | THICKNESS | OUTSIDE | INSIDE | THICKNESS | |
| S381410R | Silicon | Red | 38 | 14 | 1.0 | 1 1/2" | 35/64" | 3/64" | 25 pcs/pack |
| S381210R | Silicon | Red | 38 | 12 | 1.0 | 1 1/2" | 15/32" | 3/64" | 25 pcs/pack |
| S321410R | Silicon | Red | 32 | 14 | 1.0 | 1 1/4" | 35/64" | 3/64" | 25 pcs/pack |
| S321210R | Silicon | Red | 32 | 12 | 1.0 | 1 1/4" | 15/32" | 3/64" | 25 pcs/pack |

KOMORI / RYOBI FLAT SUCKERS IN ORIGINAL COLORS

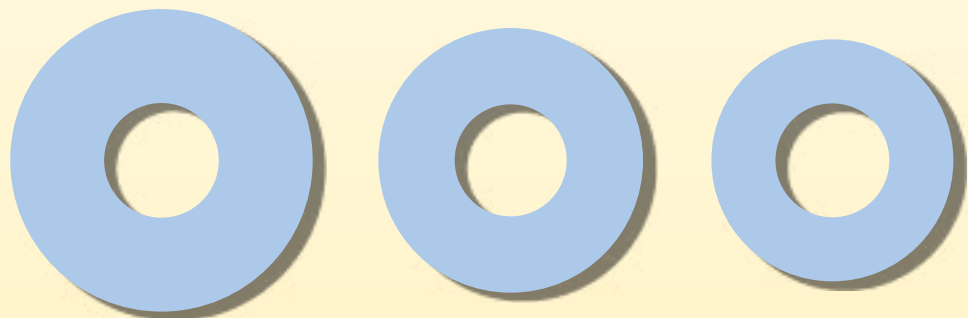

QUICK REFERENCE GUIDE

SUK40x15x10
6ZZ-4015-10ISUK35x15x10
6ZZ-3515-10ISUK32X15X08
374-1693-400

| Komori/Ryobi | | | -----MM----- | | | -----INCHES----- | | | PACKING |
|-----------------------------|----------------|-------|--------------|--------|-----------|------------------|--------|-----------|-------------|
| CODE | MATERIAL | COLOR | OUTSIDE | INSIDE | THICKNESS | OUTSIDE | INSIDE | THICKNESS | |
| SUK40X15X10 6ZZ-4015-10I | Natural Rubber | Blue | 40 | 15 | 1.0 | 1 37/64" | 19/32" | 3/64" | 25 pcs/pack |
| SUK40X14X08 6ZZ-4014-081 | Natural Rubber | Blue | 40 | 14 | 0.8 | 1 37/64" | 35/64" | 1/32" | 25 pcs/pack |
| SUK40X14X05 6ZZ-4014-051 | Natural Rubber | Blue | 40 | 14 | 0.5 | 1 37/64" | 35/64" | 1/64" | 25 pcs/pack |
| SUK38X15X08 444-1680-014 | Natural Rubber | Blue | 38 | 15 | 0.8 | 1 1/2" | 19/32" | 1/32" | 25 pcs/pack |
| SUK38X13X08 | Natural Rubber | Blue | 38 | 13 | 0.8 | 1 1/2" | 1/2" | 1/32" | 25 pcs/pack |
| SUK35X15X10 6ZZ-3515-10I | Natural Rubber | Blue | 35 | 15 | 1.0 | 1 3/8" | 19/32" | 3/64" | 25 pcs/pack |
| SUK35X15X08 444-1679-014 | Natural Rubber | Blue | 35 | 15 | 0.8 | 1 3/8" | 19/32" | 1/32" | 25 pcs/pack |
| SUK35X13X08 | Natural Rubber | Blue | 35 | 13 | 0.8 | 1 3/8" | 1/2" | 1/32" | 25 pcs/pack |
| SUK34X14X08 6ZZ-3414-081 | Natural Rubber | Blue | 34 | 14 | 0.8 | 1 11/32" | 35/64" | 1/32" | 25 pcs/pack |
| SUK32X15X08 374-1693-400 | Natural Rubber | Blue | 32 | 15 | 0.8 | 1 1/4" | 19/32" | 1/32" | 25 pcs/pack |
| SUK32X13X08 | Natural Rubber | Blue | 32 | 13 | 0.8 | 1 1/4" | 1/2" | 1/32" | 25 pcs/pack |
| SUK32X12X08 6ZZ-3212-081 | Natural Rubber | Blue | 32 | 12 | 0.8 | 1 1/4" | 15/32" | 1/32" | 25 pcs/pack |
| SUK32X11X08 374-1676-400 | Natural Rubber | Blue | 32 | 11 | 0.8 | 1 1/4" | 7/16" | 1/32" | 25 pcs/pack |
| SUK30X13X08 | Natural Rubber | Blue | 30 | 13 | 0.8 | 1 3/16" | 1/2" | 1/32" | 25 pcs/pack |

HEIDELBERG, ROLAND and Sakurai

All flat rubber suckers for press models from these four manufacturers, are kept in their original colors and have special product codes for easy identification:

Heidelberg

Heidelberg

Heidelberg

Heidelberg

Roland

Hamada

Sakurai

Heidelberg

| CODE | MATERIAL | COLOR | -----MM----- | | | -----INCHES----- | | | PACKING |
|---------------------------|-----------------|--------|--------------|--------|-----------|------------------|--------|-----------|-------------|
| | | | OUTSIDE | INSIDE | THICKNESS | OUTSIDE | INSIDE | THICKNESS | |
| S381310R | SILICON | Red | 38 | 13 | 1.0 | 1 1/2" | 1/2" | 3/64" | 25 pcs/pack |
| S381308R | SILICON | Red | 38 | 13 | 0.8 | 1 1/2" | 1/2" | 1/32" | 25 pcs/pack |
| S381305R | SILICON | Red | 38 | 13 | 0.5 | 1 1/2" | 1/2" | 1/64" | 25 pcs/pack |
| S321310R | SILICON | Red | 32 | 13 | 1.0 | 1 1/4" | 1/2" | 3/64" | 25 pcs/pack |
| S321308R 66.028.406/C | SILICON | Red | 32 | 13 | 0.8 | 1 1/4" | 1/2" | 1/32" | 25 pcs/pack |
| S321305R | SILICON | Red | 32 | 13 | 0.5 | 1 1/4" | 1/2" | 1/64" | 25 pcs/pack |
| S381310C 66.028.404/B | "PER" Synthetic | Clear | 38 | 13 | 1.0 | 1 1/2" | 1/2" | 3/64" | 25 pcs/pack |
| S321305C | "PER" Synthetic | Clear | 32 | 13 | 0.5 | 1 1/4" | 1/2" | 1/64" | 25 pcs/pack |
| S301315C | "PER" Synthetic | Clear | 30 | 13 | 1.5 | 1 3/16" | 1/2" | 1/16" | 25 pcs/pack |
| S301308C | "PER" Synthetic | Clear | 30 | 13 | 0.8 | 1 3/16" | 1/2" | 1/32" | 25 pcs/pack |
| S241008Y 89.028.401/01 | "PER" Synthetic | Yellow | 24 | 10 | 0.8 | 15/16" | 25/64" | 1/32" | 25 pcs/pack |
| S381310G 66.028.402 | Natural Rubber | Grey | 38 | 13 | 1.0 | 1 1/2" | 1/2" | 3/64" | 25 pcs/pack |
| S301308G 66.028.401 | Natural Rubber | Grey | 30 | 13 | 0.8 | 1 3/16" | 1/2" | 1/32" | 25 pcs/pack |
| S260620R | Natural Rubber | Red | 26 | 6 | 2.0 | 1 1/32" | 15/64" | 5/64" | 25 pcs/pack |
| S220516R | Natural Rubber | Red | 22 | 5 | 1.6 | 7/8" | 13/64" | 1/16" | 25 pcs/pack |
| S220320W | Natural Rubber | White | 22 | 3 | 2.0 | 7/8" | 1/8" | 5/64" | 25 pcs/pack |

Sakurai

| | | | | | | | | | |
|----------|---------|-----|----|-----|------|--------|--------|-------|-------------|
| S249885R | SILICON | Red | 24 | 9.8 | 0.85 | 15/16" | 25/64" | 1/32" | 25 pcs/pack |
|----------|---------|-----|----|-----|------|--------|--------|-------|-------------|

Roland

| | | | | | | | | | |
|------------------------|----------------|------|----|----|-----|----------|--------|-------|-------------|
| S421510B | Natural Rubber | Blue | 42 | 15 | 1.0 | 1 21/32" | 19/32" | 3/64" | 25 pcs/pack |
| S381510B S99Z702195 | Natural Rubber | Blue | 38 | 15 | 1.0 | 1 1/2" | 19/32" | 3/64" | 25 pcs/pack |
| S381507B 090R600440 | Natural Rubber | Blue | 38 | 15 | 0.7 | 1 1/2" | 19/32" | 1/32" | 25 pcs/pack |
| S351510B 090R600340 | Natural Rubber | Blue | 35 | 15 | 1.0 | 1 3/8" | 19/32" | 3/64" | 25 pcs/pack |
| S351507B | Natural Rubber | Blue | 35 | 15 | 0.7 | 1 3/8" | 19/32" | 1/32" | 25 pcs/pack |
| S351505B | Natural Rubber | Blue | 35 | 15 | 0.5 | 1 3/8" | 19/32" | 1/64" | 25 pcs/pack |
| S321510B 090R600240 | Natural Rubber | Blue | 32 | 15 | 1.0 | 1 1/4" | 19/32" | 3/64" | 25 pcs/pack |
| S321507B | Natural Rubber | Blue | 32 | 15 | 0.7 | 1 1/4" | 19/32" | 1/32" | 25 pcs/pack |

Flat Rubber Suckers

Flat Suckers – Quick and easy identification system

All flat suckers are color coded according to thickness and the product code incorporates all dimensions as well as the color of the sucker enabling quick and easy identification:

Example:

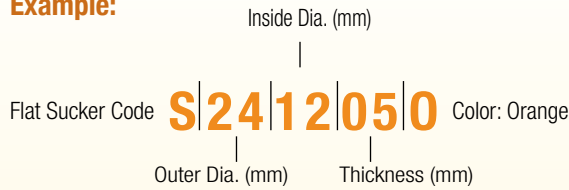

Color code:

Our rubber suckers are colored according to thickness

- Orange O N/R 0.5mm 1/64"
- Grey G N/R 0.8mm 1/32"
- Blue B N/R 1.0mm 3/64"
- Yellow Y N/R 1.5mm 1/16"
- Green N N/R 2.0mm 5/64"
- Red R SIL 1.0mm 3/64"
- Red R SIL 1.5mm 1/16"
- Clear C PER various Heidelberg

Material:

- N/R = Natural Rubber
- PER = Synthetic Material
- SIL = Silicon

Packing: 25pcs/pack

| CODE | MATERIAL | COLOR | MM | | | INCHES | | |
|----------|----------|--------|---------|--------|-----------|---------|--------|-----------|
| | | | OUTSIDE | INSIDE | THICKNESS | OUTSIDE | INSIDE | THICKNESS |
| S160208G | NR | Grey | 16 | 2 | 0.8 | 5/8" | 5/64" | 1/32" |
| S170308G | NR | Grey | 17 | 3 | 0.8 | 43/64" | 1/8" | 1/32" |
| S1902050 | NR | Orange | 19 | 2 | 0.5 | 3/4" | 5/64" | 1/64" |
| S190208G | NR | Grey | 19 | 2 | 0.8 | 3/4" | 5/64" | 1/32" |
| S1903050 | NR | Orange | 19 | 3 | 0.5 | 3/4" | 1/8" | 1/64" |
| S190308G | NR | Grey | 19 | 3 | 0.8 | 3/4" | 1/8" | 1/32" |
| S190310B | NR | Blue | 19 | 3 | 1.0 | 3/4" | 1/8" | 3/64" |
| S190608G | NR | Grey | 19 | 6 | 0.8 | 3/4" | 15/64" | 1/32" |
| S190610B | NR | Blue | 19 | 6 | 1.0 | 3/4" | 15/64" | 3/64" |
| S1907050 | NR | Orange | 19 | 7 | 0.5 | 3/4" | 9/32" | 1/64" |
| S190708G | NR | Grey | 19 | 7 | 0.8 | 3/4" | 9/32" | 1/32" |
| S190710B | NR | Blue | 19 | 7 | 1.0 | 3/4" | 9/32" | 3/64" |
| S200508G | NR | Grey | 20 | 5 | 0.8 | 25/32" | 13/64" | 1/32" |
| S210808G | NR | Grey | 21 | 8 | 0.8 | 53/64" | 5/16" | 1/32" |
| S220320W | NR | White | 22 | 3 | 2.0 | 7/8" | 1/8" | 5/64" |
| S2205050 | NR | Orange | 22 | 5 | 0.5 | 7/8" | 13/64" | 1/64" |
| S220510B | NR | Blue | 22 | 5 | 1.0 | 7/8" | 13/64" | 3/64" |
| S220516R | SIL | Red | 22 | 5 | 1.6 | 7/8" | 13/64" | 1/16" |
| S220608G | NR | Grey | 22 | 6 | 0.8 | 7/8" | 15/64" | 1/32" |
| S220610B | NR | Blue | 22 | 6 | 1.0 | 7/8" | 15/64" | 3/64" |
| S220908G | NR | Grey | 22 | 9 | 0.8 | 7/8" | 23/64" | 1/32" |
| S220920N | NR | Green | 22 | 9 | 2.0 | 7/8" | 23/64" | 5/64" |
| S220910R | SIL | Red | 22 | 9 | 1.0 | 7/8" | 23/64" | 3/64" |
| S2405050 | NR | Orange | 24 | 5 | 0.5 | 15/16" | 13/64" | 1/64" |
| S240508G | NR | Grey | 24 | 5 | 0.8 | 15/16" | 13/64" | 1/32" |
| S240510B | NR | Blue | 24 | 5 | 1.0 | 15/16" | 13/64" | 3/64" |
| S240515Y | NR | Yellow | 24 | 5 | 1.5 | 15/16" | 13/64" | 1/16" |
| S240610B | NR | Blue | 24 | 6 | 1.0 | 15/16" | 15/64" | 3/64" |
| S240610R | SIL | Red | 24 | 6 | 1.0 | 15/16" | 15/64" | 3/64" |
| S240615R | SIL | Red | 24 | 6 | 1.5 | 15/16" | 15/64" | 1/16" |
| S2409050 | NR | Orange | 24 | 9 | 0.5 | 15/16" | 23/64" | 1/64" |
| S240908G | NR | Grey | 24 | 9 | 0.8 | 15/16" | 23/64" | 1/32" |
| S240910R | SIL | Red | 24 | 9 | 1.0 | 15/16" | 23/64" | 3/64" |
| S241208G | NR | Grey | 24 | 12 | 0.8 | 15/16" | 15/32" | 1/32" |
| S241210R | SIL | Red | 24 | 12 | 1.0 | 15/16" | 15/32" | 3/64" |
| S2505050 | NR | Orange | 25 | 5 | 0.5 | 63/64" | 13/64" | 1/64" |
| S250510B | NR | Blue | 25 | 5 | 1.0 | 63/64" | 13/64" | 3/64" |
| S250605C | Per | Clear | 25 | 6 | 0.5 | 63/64" | 15/64" | 1/64" |
| S2506050 | NR | Orange | 25 | 6 | 0.5 | 63/64" | 15/64" | 1/64" |

| CODE | MATERIAL | COLOR | MM | | | INCHES | | |
|----------|----------|--------|---------|--------|-----------|---------|--------|-----------|
| | | | OUTSIDE | INSIDE | THICKNESS | OUTSIDE | INSIDE | THICKNESS |
| S250608G | NR | Grey | 25 | 6 | 0.8 | 63/64" | 15/64" | 1/32" |
| S250608R | SIL | Red | 25 | 6 | 0.8 | 63/64" | 15/64" | 1/32" |
| S250610B | NR | Blue | 25 | 6 | 1.0 | 63/64" | 15/64" | 3/64" |
| S250620N | NR | Green | 25 | 6 | 2.0 | 63/64" | 15/64" | 5/64" |
| S250610R | SIL | Red | 25 | 6 | 1.0 | 63/64" | 15/64" | 3/64" |
| S2509050 | NR | Orange | 25 | 9 | 0.5 | 63/64" | 23/64" | 1/64" |
| S250905C | Per | Clear | 25 | 9 | 0.5 | 63/64" | 23/64" | 1/64" |
| S250908G | NR | Grey | 25 | 9 | 0.8 | 63/64" | 23/64" | 1/32" |
| S250910B | NR | Blue | 25 | 9 | 1.0 | 63/64" | 23/64" | 3/64" |
| S250910R | SIL | Red | 25 | 9 | 1.0 | 63/64" | 23/64" | 3/64" |
| S251005R | SIL | Red | 25 | 10 | 0.5 | 63/64" | 25/64" | 1/64" |
| S260620R | SIL | Red | 26 | 6 | 2.0 | 1 1/32" | 15/64" | 5/64" |
| S2706050 | NR | Orange | 27 | 6 | 0.5 | 1 1/16" | 15/64" | 1/64" |
| S270610B | NR | Blue | 27 | 6 | 1.0 | 1 1/16" | 15/64" | 3/64" |
| S2709050 | NR | Orange | 27 | 9 | 0.5 | 1 1/16" | 23/64" | 1/64" |
| S270910B | NR | Blue | 27 | 9 | 1.0 | 1 1/16" | 23/64" | 3/64" |
| S270915Y | NR | Yellow | 27 | 9 | 1.5 | 1 1/16" | 23/64" | 1/16" |
| S271205R | SIL | Red | 27 | 12 | 0.5 | 1 1/16" | 15/32" | 1/64" |
| S2806050 | NR | Orange | 28 | 6 | 0.5 | 1 7/64" | 15/64" | 1/64" |
| S280608G | NR | Grey | 28 | 6 | 0.8 | 1 7/64" | 15/64" | 1/32" |
| S280610B | NR | Blue | 28 | 6 | 1.0 | 1 7/64" | 15/64" | 3/64" |
| S2809050 | NR | Orange | 28 | 9 | 0.5 | 1 7/64" | 23/64" | 1/64" |
| S2812050 | NR | Orange | 28 | 12 | 0.5 | 1 7/64" | 15/32" | 1/64" |
| S281208G | NR | Grey | 28 | 12 | 0.8 | 1 7/64" | 15/32" | 1/32" |
| S281210B | NR | Blue | 28 | 12 | 1.0 | 1 7/64" | 15/32" | 3/64" |
| S281210R | SIL | Red | 28 | 12 | 1.0 | 1 7/64" | 15/32" | 3/64" |
| S281215R | SIL | Red | 28 | 12 | 1.5 | 1 7/64" | 15/32" | 1/16" |
| S290915R | SIL | Red | 29 | 9 | 1.5 | 1 9/64" | 23/64" | 1/16" |
| S2912050 | NR | Orange | 29 | 12 | 0.5 | 1 9/64" | 15/32" | 1/64" |
| S291208G | NR | Grey | 29 | 12 | 0.8 | 1 9/64" | 15/32" | 1/32" |
| S300510B | NR | Blue | 30 | 5 | 1.0 | 1 3/16" | 13/64" | 3/64" |
| S300510R | SIL | Red | 30 | 5 | 1.0 | 1 3/16" | 13/64" | 3/64" |
| S3009050 | NR | Orange | 30 | 9 | 0.5 | 1 3/16" | 23/64" | 1/64" |
| S300908G | NR | Grey | 30 | 9 | 0.8 | 1 3/16" | 23/64" | 1/32" |
| S300910B | NR | Blue | 30 | 9 | 1.0 | 1 3/16" | 23/64" | 3/64" |
| S300915Y | NR | Yellow | 30 | 9 | 1.5 | 1 3/16" | 23/64" | 1/16" |
| S300910R | SIL | Red | 30 | 9 | 1.0 | 1 3/16" | 23/64" | 3/64" |
| S3011050 | NR | Orange | 30 | 11 | 0.5 | 1 3/16" | 7/16" | 1/64" |
| S301110R | SIL | Red | 30 | 11 | 1.0 | 1 3/16" | 7/16" | 3/64" |
| S3012050 | NR | Orange | 30 | 12 | 0.5 | 1 3/16" | 15/32" | 1/64" |
| S301208G | NR | Grey | 30 | 12 | 0.8 | 1 3/16" | 15/32" | 1/32" |

Material:
 N/R = Natural Rubber
 PER = Synthetic Material
 SIL = Silicon

Color code:
 Our rubber suckers are colored according to thickness
 Orange O 0.5mm 1/64" Green N 2.0mm 5/64"
 Grey G 0.8mm 1/32" Red R 1.0mm 3/64"
 Blue B 1.0mm 3/64" Red R 1.5mm 1/16"
 Yellow Y 1.5mm 1/16"

An example:



| CODE | MATERIAL | COLOR | MM | | | INCHES | | |
|----------|----------|--------|---------|--------|-----------|----------|--------|-----------|
| | | | OUTSIDE | INSIDE | THICKNESS | OUTSIDE | INSIDE | THICKNESS |
| S301210B | NR | Blue | 30 | 12 | 1.0 | 1 3/16" | 15/32" | 3/64" |
| S301215Y | NR | Yellow | 30 | 12 | 1.5 | 1 3/16" | 15/32" | 1/16" |
| S301305O | NR | Orange | 30 | 13 | 0.5 | 1 3/16" | 1/2" | 1/64" |
| S301308G | NR | Grey | 30 | 13 | 0.8 | 1 3/16" | 1/2" | 1/32" |
| S301310B | NR | Blue | 30 | 13 | 1.0 | 1 3/16" | 1/2" | 3/64" |
| S301315C | Per | Clear | 30 | 13 | 1.5 | 1 3/16" | 1/2" | 1/16" |
| S301315Y | NR | Yellow | 30 | 13 | 1.5 | 1 3/16" | 1/2" | 1/16" |
| S301310R | SIL | Red | 30 | 13 | 1.0 | 1 3/16" | 1/2" | 3/64" |
| S301405O | NR | Orange | 30 | 14 | 0.5 | 1 3/16" | 35/64" | 1/64" |
| S301408G | NR | Grey | 30 | 14 | 0.8 | 1 3/16" | 35/64" | 1/32" |
| S301410B | NR | Blue | 30 | 14 | 1.0 | 1 3/16" | 35/64" | 3/64" |
| S301415Y | NR | Yellow | 30 | 14 | 1.5 | 1 3/16" | 35/64" | 1/16" |
| S301420N | NR | Green | 30 | 14 | 2.0 | 1 3/16" | 35/64" | 5/64" |
| S301410R | SIL | Red | 30 | 14 | 1.0 | 1 3/16" | 35/64" | 3/64" |
| S301415R | SIL | Red | 30 | 14 | 1.5 | 1 3/16" | 35/64" | 1/16" |
| S320508G | NR | Grey | 32 | 5 | 0.8 | 1 1/4" | 13/64" | 1/32" |
| S320520N | NR | Green | 32 | 5 | 2.0 | 1 1/4" | 13/64" | 5/64" |
| S320608G | NR | Grey | 32 | 6 | 0.8 | 1 1/4" | 15/64" | 1/32" |
| S320610B | NR | Blue | 32 | 6 | 1.0 | 1 1/4" | 15/64" | 3/64" |
| S321007B | NR | Blue | 32 | 10 | 0.7 | 1 1/4" | 25/64" | 1/32" |
| S321108G | NR | Grey | 32 | 11 | 0.8 | 1 1/4" | 7/16" | 1/32" |
| S321110B | NR | Blue | 32 | 11 | 1.0 | 1 1/4" | 7/16" | 3/64" |
| S321115Y | NR | Yellow | 32 | 11 | 1.5 | 1 1/4" | 7/16" | 1/16" |
| S321110R | SIL | Red | 32 | 11 | 1.0 | 1 1/4" | 7/16" | 3/64" |
| S321208G | NR | Grey | 32 | 12 | 0.8 | 1 1/4" | 15/32" | 1/32" |
| S321208R | SIL | Red | 32 | 12 | 0.8 | 1 1/4" | 15/32" | 1/32" |
| S321210B | NR | Blue | 32 | 12 | 1.0 | 1 1/4" | 15/32" | 3/64" |
| S321210R | SIL | Red | 32 | 12 | 1.0 | 1 1/4" | 15/32" | 3/64" |
| S321305O | NR | Orange | 32 | 13 | 0.5 | 1 1/4" | 1/2" | 1/64" |
| S321308C | Per | Clear | 32 | 13 | 0.8 | 1 1/4" | 1/2" | 1/32" |
| S321308G | NR | Grey | 32 | 13 | 0.8 | 1 1/4" | 1/2" | 1/32" |
| S321310B | NR | Blue | 32 | 13 | 1.0 | 1 1/4" | 1/2" | 3/64" |
| S321315Y | NR | Yellow | 32 | 13 | 1.5 | 1 1/4" | 1/2" | 1/16" |
| S321310R | SIL | Red | 32 | 13 | 1.0 | 1 1/4" | 1/2" | 3/64" |
| S321315R | SIL | Red | 32 | 13 | 1.5 | 1 1/4" | 1/2" | 1/16" |
| S321408G | NR | Grey | 32 | 14 | 0.8 | 1 1/4" | 35/64" | 1/32" |
| S321505O | NR | Orange | 32 | 15 | 0.5 | 1 1/4" | 19/32" | 1/64" |
| S321508G | NR | Grey | 32 | 15 | 0.8 | 1 1/4" | 19/32" | 1/32" |
| S321510B | NR | Blue | 32 | 15 | 1.0 | 1 1/4" | 19/32" | 3/64" |
| S321510R | SIL | Red | 32 | 15 | 1.0 | 1 1/4" | 19/32" | 3/64" |
| S331508G | NR | Grey | 33 | 15 | 0.8 | 1 19/64" | 19/32" | 1/32" |
| S331515Y | NR | Yellow | 33 | 15 | 1.5 | 1 19/64" | 19/32" | 1/16" |
| S331510R | SIL | Red | 33 | 15 | 1.0 | 1 19/64" | 19/32" | 3/64" |
| S350605O | NR | Orange | 35 | 6 | 0.5 | 1 3/8" | 15/64" | 1/64" |
| S350608G | NR | Grey | 35 | 6 | 0.8 | 1 3/8" | 15/64" | 1/32" |
| S350610B | NR | Blue | 35 | 6 | 1.0 | 1 3/8" | 15/64" | 3/64" |
| S350610R | SIL | Red | 35 | 6 | 1.0 | 1 3/8" | 15/64" | 3/64" |
| S351008G | NR | Grey | 35 | 10 | 0.8 | 1 3/8" | 25/64" | 1/32" |
| S351210B | NR | Blue | 35 | 12 | 1.0 | 1 3/8" | 15/32" | 3/64" |
| S351210R | SIL | Red | 35 | 12 | 1.0 | 1 3/8" | 15/32" | 3/64" |
| S351215R | SIL | Red | 35 | 12 | 1.5 | 1 3/8" | 15/32" | 1/16" |
| S351310B | NR | Blue | 35 | 13 | 1.0 | 1 3/8" | 1/2" | 3/64" |
| S351408G | NR | Grey | 35 | 14 | 0.8 | 1 3/8" | 35/64" | 1/32" |
| S351505O | NR | Orange | 35 | 15 | 0.5 | 1 3/8" | 19/32" | 1/64" |

| CODE | MATERIAL | COLOR | MM | | | INCHES | | |
|----------|----------|--------|---------|--------|-----------|----------|--------|-----------|
| | | | OUTSIDE | INSIDE | THICKNESS | OUTSIDE | INSIDE | THICKNESS |
| S351508G | NR | Grey | 35 | 15 | 0.8 | 1 3/8" | 19/32" | 1/32" |
| S351510B | NR | Blue | 35 | 15 | 1.0 | 1 3/8" | 19/32" | 3/64" |
| S351515Y | NR | Yellow | 35 | 15 | 1.5 | 1 3/8" | 19/32" | 1/16" |
| S351510R | SIL | Red | 35 | 15 | 1.0 | 1 3/8" | 19/32" | 3/64" |
| S361505O | NR | Orange | 36 | 15 | 0.5 | 1 27/64" | 19/32" | 1/64" |
| S361510R | SIL | Red | 36 | 15 | 1.0 | 1 27/64" | 19/32" | 3/64" |
| S380515Y | NR | Yellow | 38 | 5 | 1.5 | 1 1/2" | 13/64" | 1/16" |
| S380515R | SIL | Red | 38 | 5 | 1.5 | 1 1/2" | 13/64" | 1/16" |
| S380910R | SIL | Red | 38 | 9 | 1.0 | 1 1/2" | 23/64" | 3/64" |
| S381105O | NR | Orange | 38 | 11 | 0.5 | 1 1/2" | 7/16" | 1/64" |
| S381108G | NR | Grey | 38 | 11 | 0.8 | 1 1/2" | 7/16" | 1/32" |
| S381110B | NR | Blue | 38 | 11 | 1.0 | 1 1/2" | 7/16" | 3/64" |
| S381110R | SIL | Red | 38 | 11 | 1.0 | 1 1/2" | 7/16" | 3/64" |
| S381205O | NR | Orange | 38 | 12 | 0.5 | 1 1/2" | 15/32" | 1/64" |
| S381208G | NR | Grey | 38 | 12 | 0.8 | 1 1/2" | 15/32" | 1/32" |
| S381210B | NR | Blue | 38 | 12 | 1.0 | 1 1/2" | 15/32" | 3/64" |
| S381210R | SIL | Red | 38 | 12 | 1.0 | 1 1/2" | 15/32" | 3/64" |
| S381305O | NR | Orange | 38 | 13 | 0.5 | 1 1/2" | 1/2" | 1/64" |
| S381308G | NR | Grey | 38 | 13 | 0.8 | 1 1/2" | 1/2" | 1/32" |
| S381310B | NR | Blue | 38 | 13 | 1.0 | 1 1/2" | 1/2" | 3/64" |
| S381315Y | NR | Yellow | 38 | 13 | 1.5 | 1 1/2" | 1/2" | 1/16" |
| S381310R | SIL | Red | 38 | 13 | 1.0 | 1 1/2" | 1/2" | 3/64" |
| S381405O | NR | Orange | 38 | 14 | 0.5 | 1 1/2" | 35/64" | 1/64" |
| S381408G | NR | Grey | 38 | 14 | 0.8 | 1 1/2" | 35/64" | 1/32" |
| S381410B | NR | Blue | 38 | 14 | 1.0 | 1 1/2" | 35/64" | 3/64" |
| S381410R | SIL | Red | 38 | 14 | 1.0 | 1 1/2" | 35/64" | 3/64" |
| S381505O | NR | Orange | 38 | 15 | 0.5 | 1 1/2" | 19/32" | 1/64" |
| S381508G | NR | Grey | 38 | 15 | 0.8 | 1 1/2" | 19/32" | 1/32" |
| S381510B | NR | Blue | 38 | 15 | 1.0 | 1 1/2" | 19/32" | 3/64" |
| S381515Y | NR | Yellow | 38 | 15 | 1.5 | 1 1/2" | 19/32" | 1/16" |
| S381510R | SIL | Red | 38 | 15 | 1.0 | 1 1/2" | 19/32" | 3/64" |
| S381515R | SIL | Red | 38 | 15 | 1.5 | 1 1/2" | 19/32" | 1/16" |
| S391508G | NR | Grey | 39 | 15 | 0.8 | 1 17/32" | 19/32" | 1/32" |
| S391510B | NR | Blue | 39 | 15 | 1.0 | 1 17/32" | 19/32" | 3/64" |
| S400910B | NR | Blue | 40 | 9 | 1.0 | 1 37/64" | 23/64" | 3/64" |
| S400910R | SIL | Red | 40 | 9 | 1.0 | 1 37/64" | 23/64" | 3/64" |
| S400915R | SIL | Red | 40 | 9 | 1.5 | 1 37/64" | 23/64" | 1/16" |
| S410908G | NR | Grey | 41 | 9 | 0.8 | 1 39/64" | 23/64" | 1/32" |
| S410920N | NR | Green | 41 | 9 | 2.0 | 1 39/64" | 23/64" | 5/64" |
| S411205O | NR | Orange | 41 | 12 | 0.5 | 1 39/64" | 15/32" | 1/64" |
| S411210B | NR | Blue | 41 | 12 | 1.0 | 1 39/64" | 15/32" | 3/64" |
| S411405O | NR | Orange | 41 | 14 | 0.5 | 1 39/64" | 35/64" | 1/64" |
| S411408G | NR | Grey | 41 | 14 | 0.8 | 1 39/64" | 35/64" | 1/32" |
| S411410B | NR | Blue | 41 | 14 | 1.0 | 1 39/64" | 35/64" | 3/64" |
| S411415Y | NR | Yellow | 41 | 14 | 1.5 | 1 39/64" | 35/64" | 1/16" |
| S411410R | SIL | Red | 41 | 14 | 1.0 | 1 39/64" | 35/64" | 3/64" |
| S411415R | SIL | Red | 41 | 14 | 1.5 | 1 39/64" | 35/64" | 1/16" |
| S411605O | NR | Orange | 41 | 16 | 0.5 | 1 39/64" | 5/8" | 1/64" |
| S421510B | NR | Blue | 42 | 15 | 1.0 | 1 21/32" | 19/32" | 3/64" |
| S440815R | SIL | Red | 44 | 8 | 1.5 | 1 47/64" | 5/16" | 1/16" |
| S451310B | NR | Blue | 45 | 13 | 1.0 | 1 49/64" | 1/2" | 3/64" |
| S451315Y | NR | Yellow | 45 | 13 | 1.5 | 1 49/64" | 1/2" | 1/16" |
| S451408G | NR | Grey | 45 | 14 | 0.8 | 1 49/64" | 35/64" | 1/32" |
| S451410B | NR | Blue | 45 | 14 | 1.0 | 1 49/64" | 35/64" | 3/64" |

Material:

N/R = Natural Rubber
 PER = Synthetic Material
 SIL = Silicon

Color code:

Our rubber suckers are colored according to thickness

| | | | | | | | |
|--------|---|-------|-------|-------|---|-------|-------|
| Orange | O | 0.5mm | 1/64" | Green | N | 2.0mm | 5/64" |
| Grey | G | 0.8mm | 1/32" | Red | R | 1.0mm | 3/64" |
| Blue | B | 1.0mm | 3/64" | Red | R | 1.5mm | 1/16" |
| Yellow | Y | 1.5mm | 1/16" | | | | |

An example:

Inside Dia. Color

Flat Sucker Code **S** **24** **12** **05** **0**

Outer Dia. Thickness

| CODE | MATERIAL | COLOR | MM | | | INCHES | | |
|----------|----------|--------|---------|--------|-----------|----------|--------|-----------|
| | | | OUTSIDE | INSIDE | THICKNESS | OUTSIDE | INSIDE | THICKNESS |
| S451510B | NR | Blue | 45 | 15 | 1.0 | 1 49/64" | 19/32" | 3/64" |
| S451520N | NR | Green | 45 | 15 | 2.0 | 1 49/64" | 19/32" | 5/64" |
| S451510R | SIL | Red | 45 | 15 | 1.0 | 1 49/64" | 19/32" | 3/64" |
| S451515R | SIL | Red | 45 | 15 | 1.5 | 1 49/64" | 19/32" | 1/16" |
| S451610B | NR | Blue | 45 | 16 | 1.0 | 1 49/64" | 5/8" | 3/64" |
| S451615Y | NR | Yellow | 45 | 16 | 1.5 | 1 49/64" | 5/8" | 1/16" |
| S451620N | NR | Green | 45 | 16 | 2.0 | 1 49/64" | 5/8" | 5/64" |
| S451610R | SIL | Red | 45 | 16 | 1.0 | 1 49/64" | 5/8" | 3/64" |
| S451708G | NR | Grey | 45 | 17 | 0.8 | 1 49/64" | 43/64" | 1/32" |
| S451720N | NR | Green | 45 | 17 | 2.0 | 1 49/64" | 43/64" | 5/64" |
| S500620N | NR | Green | 50 | 6 | 2.0 | 1 31/32" | 15/64" | 5/64" |
| S500808G | NR | Grey | 50 | 8 | 0.8 | 1 31/32" | 5/16" | 1/32" |
| S500810B | NR | Blue | 50 | 8 | 1.0 | 1 31/32" | 5/16" | 3/64" |
| S500815Y | NR | Yellow | 50 | 8 | 1.5 | 1 31/32" | 5/16" | 1/16" |
| S500820N | NR | Green | 50 | 8 | 2.0 | 1 31/32" | 5/16" | 5/64" |
| S500810R | SIL | Red | 50 | 8 | 1.0 | 1 31/32" | 5/16" | 3/64" |

LubeClean

LUBRICATES AND CLEANS!



Code: LUBECLEAN

LubeClean is an exceptional product that has taken the graphics industry by storm. Formulated to prevent friction burn-up of ink rollers on idle printing units during printing, LubeClean also gently deep cleans and rejuvenates the rollers!

LubeClean cleans off quick and easy at the end of the shift and contrary to other products on the market it has a very pleasant fragrance.

LubeClean does not harm plates or blankets and works with both conventional and UV ink.

Instant benefits:

- Lubricates AND deep cleans inking rollers
- Will not harm plates or blankets
- Quick and easy to clean off at the end of shift
- Pleasant fragrance during use
- Works with conventional and UV ink
- Non-caustic
- Non-toxic
- Non-flammable

Packing: 900 gram (2.0 lbs)/can - 12 cans/box

A *Master* PRODUCT

Dedication to customer satisfaction and quality products as well as investment in modern production facilities have ensured that Master products are now distributed world-wide.

This rapid expansion rests on a firm foundation of old fashioned business principles:

- Quality products
- Competitive pricing
- Quick delivery
- Innovative product and packaging design

All *Master* products have been thoroughly tested in the international market and are accepted for their high performance and durability.



ROLLER MASTER

A new, highly effective, "easy to apply" roller cleaning paste. Excellent for both UV and standard ink.

This "non-grit" formulation has no impact on plate wear and no harmful effect on rubber or chrome rollers.

Roller Master maintains rollers in perfect "like new" condition.



Code: RM1

- Removes ink, glaze and calcium from roller surfaces
- High viscosity, "easy to apply" paste
- Contains no abrasives, will not cause plate wear
- Will not harm NBR or EPDM rollers
- Contains no strong solvents
- Stable in a wide range of temperatures
- Zero VOC

Packing: 1 kilo (2.2lbs)/can - 12 cans/box

Deletion/Addition Pens

A great range of pens made with a special long lasting tip.



Packing: 10 pens per box

Deletion Pens: Removes image quickly and safely on all positive and most negative plates.

| Code: | Description: |
|--------------|---|
| DPENF | Deletion pen with fine tip |
| DPENL | Deletion pen with medium/large tip |

CTP Deletion Pens: Only for thermal CTP plates and not for use with violet plates.

| Code: | Description: |
|----------------|---|
| CTDPENF | CTP deletion pen with fine tip |
| CTDPENL | CTP deletion pen with medium/large tip |

Addition Pens: Great touch up pens to fill in pin holes, repair broken solids and add image on all metal plates.

| Code: | Description: |
|---------------|---|
| ADPENF | Addition pen with fine tip |
| ADPENL | Addition pen with medium/large tip |

Positive Deletion Gel



Code: POSGEL

- Easy to apply - no bleeding of fluid
- Precise correction/deletion possible
- Will not attack the oxide surface of the plate
- Removes all coating residues from the plate pores

Packing: 100ml bottle / 10 x 100 bottles per box

REVIVE! Blanket Repair



Code: RBR250

Allows a print run to be completed despite a smash. Apply REVIVE! to the affected area using the brush applicator. Leave for several seconds and wipe clean.

REVIVE! will swell the low spot back to its original level without damaging the blanket. Supplied with brush applicator.

Packing: 250ml can / 6 x 250ml cans per box

